

System Manual

(Extension)

9300 vector 0,37 ... 400 kW



EVF9321 ... EVF9333, EVF9335 ... EVF9338, EVF9381 ... EVF9383

Frequency inverter

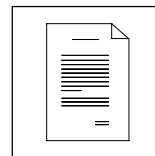

1 Preface

Contents

1.1	How to use this Manual	1-3
1.1.1	Which information does the System Manual contain?	1-3
1.1.2	Products to which the System Manual applies	1-5
1.2	Definition of notes used	1-6

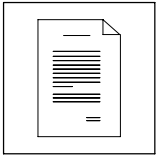

Preface

Contents

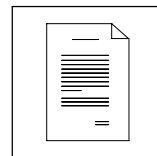

1.1 How to use this Manual

1.1.1 Which information does the System Manual contain?

Target group

This System Manual (extension) is intended for all persons who design, install, commission, and adjust the 9300 vector frequency inverter.

Together with the System Manual, document number EDSVF9333V or EDSVF9383V, and the catalogue it forms the project planning basis for machine and system builders.

The System Manual (extension) is only valid together with the System Manual, document number EDSVF9333V or EDSVF9383V.

Contents

The System Manual (extension) completes the System Manual, document number EDSVF9333V or EDSVF9383V:

- The features and functions are described in detail.
- It describes in detail additional possible applications.
- Examples describe how to set the parameters for typical applications.
- In case of doubt, the Operating Instructions delivered together with the 9300 vector frequency inverter always apply.

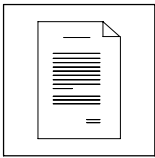

Preface

How to use this Manual

①	②	Contents of the System Manual	Contents of the System Manual (extension)
1	1	Preface	1 Preface
2	2	Safety	-
3	3	Technical data	-
4	4	Installing the basic device	-
5	5	Wiring the basic device	-
6	6	Commissioning	-
7	7	Parameter setting	-
8	8	Configuration	2 Configuration
	8.1	Function block description Function block description Diameter calculator (DCALC) Digital frequency input (DFIN) Digital frequency output (DFOUT) Digital frequency ramp function generator (DFRFG) Digital frequency processing (DFSET) Internal motor control with V/f characteristic control (MCTRL1) Internal motor control with vector control (MCTRL2)	2.1 Configuration with Global Drive Control 2.2 Basic configuration
	8.2	Code table	2.3 Use of function blocks
	8.3	Selection lists	2.4 Function blocks (Description of additional function blocks)
	8.4	Attribute table	2.5 Monitorings
9	9	Troubleshooting and fault elimination	-
10	10	DC-bus operation	-
11	11	Safe standstill	-
-	12	Braking operation	-
-	-	-	3 Application examples
-	-	-	4 Signal flow charts
12	13	Accessories	-
13	14	Appendix	5 Appendix

① Chapters contained in the System Manual (EDSVF9333V) for EVF9321 ... EVF9333 frequency inverters

② Chapters contained in the System Manual (EDSVF9383V) for EVF9335 ... EVF9338, EVF9381 ... EVF9383 frequency inverters

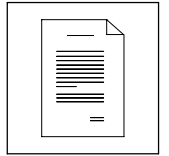

How to find information

Use the System Manual as basis. It contains references to the corresponding chapters in the System Manual (extension):

- Each chapter is a complete unit and informs entirely about a subject.
- The Table of Contents and Index help you to find all information about a certain topic.
- Descriptions and data of other Lenze products (drive PLC, Lenze geared motors, Lenze motors, ...) can be found in the corresponding catalogues, Operating Instructions and Manuals. The required documentation can be ordered at your Lenze sales partner or downloaded as PDF file from the Internet.



Note!

Current documentation and software updates for Lenze products can be found on the Internet in the "Download" area under <http://www.Lenze.com>

1.1.2 Products to which the System Manual applies

This documentation applies to 9300 frequency inverters as of version:

- EVF9321-xV Vxxx xx 6x ... EVF9333-xV Vxxx xx 6x
- EVF9335-EV Vxxx xx 6x ... EVF9338-EV Vxxx xx 6x
- EVF9381-EV Vxxx xx 6x ... EVF9383-EV Vxxx xx 6x

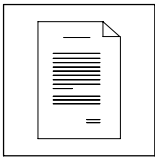

Preface

Definition of notes used





1.2 Definition of notes used

All safety information given in these Instructions have the same layout:

 Pictograph (indicates the type of danger)

Signal word! (indicates the severity of danger)

Note (describes the danger and explains how to avoid it)

	Pictograms used		Signal words	
Warning of damage to persons		Warning of dangerous electrical voltage	Danger!	Warns of impending danger . If disregarded: Death or most severe injuries
		Warning of general danger	Warning!	Warns of possible and very dangerous situations . If disregarded: Death or most severe injuries
Warning of damage to material			Caution!	Warns of possible and dangerous situations . If disregarded: Minor injuries
			Stop!	Warns of possible damage to material . If disregarded: Damage of the controller/drive system or its environment
Other notes			Note!	Indicates a useful tip. If you follow this tip, handling of the controller/drive system will be easier.

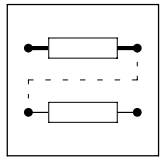

2 Configuration

Contents

2.1	Configuration by means of Global Drive Control	2-5
2.2	Basic configuration	2-6
2.2.1	Changing the basic configuration	2-7
2.2.2	Control	2-8
2.2.3	Speed control (C0005 = 1000)	2-9
2.2.4	Step control (C0005 = 2000)	2-11
2.2.5	Traversing control (C0005 = 3000)	2-14
2.2.6	Torque control (C0005 = 4000)	2-17
2.2.7	Digital frequency - master (C0005 = 5000)	2-19
2.2.8	Digital frequency – slave (bus) (C0005 = 6000)	2-21
2.2.9	Digital frequency – slave (cascade) (C0005 = 7000)	2-23
2.2.10	Dancer position control with external diameter detection (C0005 = 8000)	2-26
2.2.11	Dancer position control with internal diameter detection (C0005 = 9000)	2-30
2.3	Use of function blocks	2-34
2.3.1	Signal types	2-34
2.3.2	Function block elements	2-35
2.3.3	Connecting function blocks	2-37
2.3.4	Entries in the processing table	2-41
2.4	Function blocks	2-43
2.4.1	List of function blocks	2-43
2.4.2	List of free control codes	2-45
2.4.3	Absolute value generation (ABS)	2-46
2.4.4	Addition (ADD)	2-47
2.4.5	Automation interface (AIF-IN)	2-48
2.4.6	Automation interface (AIF-OUT)	2-51
2.4.7	Analog inputs via terminal X6/1,2 and X6/3,4 (AIN)	2-53
2.4.8	Logic AND (AND)	2-55
2.4.9	Inversion (ANEG)	2-58
2.4.10	Analog outputs via terminals X6/62 and X6/63 (AOUT)	2-59
2.4.11	Arithmetic (ARIT)	2-61
2.4.12	Toggling (ASW)	2-63
2.4.13	Holding brake (BRK)	2-65
2.4.14	System bus (CAN-IN)	2-70
2.4.15	System bus (CAN-OUT)	2-70
2.4.16	Comparison (CMP)	2-71
2.4.17	Conversion (CONV)	2-76
2.4.18	Conversion phase to analog (CONVPHA)	2-78
2.4.19	Characteristic function (CURVE)	2-79
2.4.20	Dead band (DB)	2-82
2.4.21	Diameter calculator (DCALC)	2-83
2.4.22	Device control (DCTRL)	2-84
2.4.23	Digital frequency input (DFIN)	2-88
2.4.24	Digital frequency output (DFOUT)	2-89
2.4.25	Digital frequency ramp function generator (DFRFG)	2-90

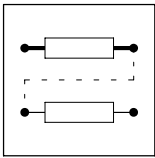

Configuration

Contents

2.4.26	Digital frequency processing (DFSET)	2-91
2.4.27	Delay (DIGDEL)	2-92
2.4.28	Digital inputs (DIGIN)	2-95
2.4.29	Digital outputs (DIGOUT)	2-96
2.4.30	Differentiation (DT1-1)	2-97
2.4.31	Counter (FCNT)	2-98
2.4.32	Free digital outputs (FDO)	2-100
2.4.33	Code assignment (FEVAN)	2-102
2.4.34	Programming of fixed setpoints (FIXSET)	2-105
2.4.35	Flipflop (FLIP)	2-107
2.4.36	Curve follower (FOLL)	2-109
2.4.37	Integrator (INT)	2-111
2.4.38	Limitation (LIM)	2-113
2.4.39	Internal motor control with V/f characteristic control (MCTRL1)	2-114
2.4.40	Internal motor control with vector control (MCTRL2)	2-115
2.4.41	Mains failure control (MFAIL)	2-116
2.4.42	Motor phase failure detection (MLP)	2-128
2.4.43	Monitor outputs of monitoring system (MONIT)	2-129
2.4.44	Motor potentiometer (MPOT)	2-130
2.4.45	Blocking frequencies (NLIM)	2-133
2.4.46	Logic NOT	2-134
2.4.47	Speed preconditioning (NSET)	2-136
2.4.48	Logic OR	2-142
2.4.49	Oscilloscope function (OSZ)	2-145
2.4.50	Process controller (PCTRL)	2-146
2.4.51	Delay (PT1)	2-151
2.4.52	Ramp function generator (RFG)	2-152
2.4.53	CW/CCW/Quick stop (R/L/Q)	2-154
2.4.54	Sample & Hold (S&H)	2-155
2.4.55	Square-root calculator (SQRT)	2-156
2.4.56	S-ramp function generator (SRFG)	2-157
2.4.57	Output of digital status signals (STAT)	2-160
2.4.58	Edge evaluation (TRANS)	2-161

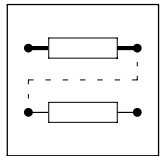

2.5	Monitorings	2-164
2.5.1	Monitoring functions	2-165
2.5.2	System monitoring (CCr)	2-166
2.5.3	Communication monitoring (CE0)	2-166
2.5.4	Communication monitoring (CE1, CE2, CE3)	2-166
2.5.5	Communication monitoring (CE4)	2-166
2.5.6	Monitoring of the external encoder (EEr)	2-167
2.5.7	Monitoring of the thermal sensors inside the device (H10, H11)	2-167
2.5.8	Monitoring of the motor phases (LP1)	2-168
2.5.9	Monitoring of the maximum speed (NMAX)	2-169
2.5.10	Short-circuit monitoring (OC1)	2-169
2.5.11	Short-circuit monitoring (OC2)	2-170
2.5.12	Overload monitoring for acceleration and deceleration (OC3)	2-170
2.5.13	l x t overload monitoring (OC5)	2-171
2.5.14	Monitoring of the heatsink temperature with fixed threshold (OH)	2-171
2.5.15	Monitoring of the heatsink temperature with adjustable threshold (OH4)	2-172
2.5.16	Motor temperature monitoring (OH8)	2-173
2.5.17	Motor temperature monitoring with fixed threshold (OH3)	2-174
2.5.18	Motor temperature monitoring with adjustable threshold (OH7)	2-175
2.5.19	Undervoltage monitoring in the DC bus (LU)	2-176
2.5.20	Overvoltage monitoring in the DC bus (OU)	2-178
2.5.21	Monitoring for initialisation errors (PI)	2-179
2.5.22	Monitoring for parameter set errors (PR0)	2-179
2.5.23	Monitoring for parameter set errors (PR1, PR2, PR3, PR4)	2-179
2.5.24	Encoder monitoring at pin X9/8 (Sd3)	2-180
2.5.25	Encoder monitoring at X6/1, X6/2 (Sd5)	2-180
2.5.26	Sensor monitoring for the motor temperature detection (Sd6)	2-181
2.5.27	Error message via digital output	2-182

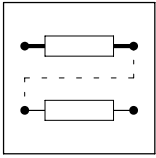

Configuration

Contents

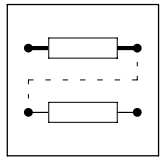

2.1 Configuration by means of Global Drive Control

In practice, every application requires an adapted controller-internal configuration. In general, a number of different function blocks are available which must be linked together in a suitable configuration. (☞ 2-37)

With Global Drive Control (GDC), Lenze offers an easy-to-understand, clearly-laid-out and convenient tool for the configuration of your specific drive task.

Function block library

GDC provides an easy-to-read library of available function blocks (FB). GDC also displays the complete assignment of an FB.

Signal configuration

The signal configuration is done with only one dialog box. It is a convenient way

- to display every FB as a block diagram.
- to see the assignment of all signal inputs at a glance.
- to enter the FB in the processing table.
- to print your signal configuration.

Terminal assignment

Freely assignable terminals can be configured using two dialog boxes:

- Dialog box - to link digital inputs and outputs.
- Dialog box - to link analog inputs and outputs.

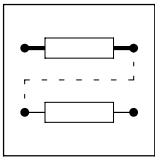

Configuration

Basic configuration

2.2 Basic configuration



Stop!

Under code C0005 you can load predefined basic configurations. If the configuration is changed via C0005, all input and output assignments will be overwritten with the corresponding basic configuration. If necessary, adapt the function assignment to your wiring.

For adapting the function assignment to a certain wiring or extended signal processing, please see the chapter "Use of function blocks".

A predefined basic configuration is selected to adapt the internal signal processing to your drive task (e.g. step control or dancer position control). Using the default setting, you can e.g. already control the speed of the drive.

- For a detailed description of the individual basic configurations, terminal assignments, signal flow charts and applications examples, please see the chapter "Application examples".
- Before loading the basic configuration under C0005, the controller must be inhibited.

Under C0005, you can select and activate predefined basic configurations. A four-digit number is used for selection with specific characteristics being assigned to each digit.

First digit

Defines the basic function of the configuration.

Configuration of C0005	Basic function
1xxx	Speed control
2xxx	Step control
3xxx	Traversing control
4xxx	Torque control
5xxx	Digital frequency master
6xxx	Digital frequency slave (bus)
7xxx	Digital frequency slave (cascade)
8xxx	Dancer position control (external diameter detection)
9xxx	Dancer position control (internal diameter detection)

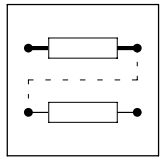

Second digit

Defines the additional function. Extends the basic function.

Configuration of C0005	Additional function
x0xx	No additional function
x1xx	Brake control via digital output X5/A2
x2xx	Setpoint selection via motor potentiometer
x3xx	PID-controller for process data control
x4xx	Mains failure control
x5xx	Setpoint selection via digital frequency input
x6xx	Analog gearbox factor trimming
x7xx	Digital gearbox factor trimming
x8xx	Digital frequency ramp function generator



Note!

The most important codes for parameterising the basic configurations can be found in the GLOBAL DRIVE CONTROL program and via the keypad under the "Short setup" menu items.

Third digit

Defines if an internal or external voltage supply is to be used for the analog and digital control inputs.

Configuration of C0005	Supply voltage
xx0x	External
xx1x	Internal via terminal X5/A1 and X6/63

Fourth digit

Defines the controller interface for reading certain control signals (e.g. speed setpoint).

Configuration of C0005	Interface
xxx0	Control terminals
xxx1	RS 232, RS 485 or optical fibre
xxx3	INTERBUS or PROFIBUS-DP
xxx5	System bus (CAN)

2.2.1 Changing the basic configuration

If a basic configuration must be changed to meet specific requirements, proceed as follows:

1. Select a basic configuration that largely meets your requirements under C0005.
2. Add functions that are not available by:
 - Changing the input and/or output configurations.
 - Parameterising function blocks. (▢ 2-35)
 - Adding or removing function blocks. (▢ 2-41)



Note!

If you change the signal flow of the basic configuration, e.g. by adding function blocks, C0005 will be set to 0. "COMMON" will be displayed on the display.

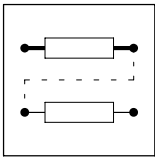

Configuration

Basic configuration

2.2.2 Control

The controller can be controlled via terminals (X5 and X6), a fieldbus module at X1, the system bus (X4) or by a combination of these.

Under the fourth digit of code C0005 you can select the interface used to control the controller.

Example: C0005 = 1005

This configuration corresponds to speed control with control via the system bus (CAN).

If you want to control further FB inputs via an interface, you first have to

- assign "control objects" to the FB inputs to be controlled depending on the interface that is used (see chapter 2.3.3):
 - Free control codes for control via LECOM A/B/LI (RS232, RS485 or optical fibre interface) or operating module.
 - AIF objects for control, e.g. via INTERBUS or PROFIBUS-DP.
 - CAN objects for control via system bus.
- After this, the inputs can be controlled via these codes or input objects by accessing them via the interface.

Example: Distributing control to terminals and RS232:

The main speed setpoint in configuration C0005=1000 shall be controlled via LECOM A/B/LI. All other inputs continue to be controlled via terminals.

1. Select C0780 via LECOM:
 - C0780 is the configuration code for the main setpoint NSET-N in the function block "Speed setpoint conditioning" (NSET).
2. Assign a free control code via the selection number:
 - E.g. 19515 (control code C0141).

The main speed setpoint is now controlled via C0141.

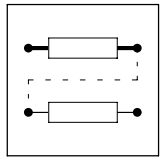

2.2.3 Speed control (C0005 = 1000)

The configuration C0005 = 1000 (Lenze setting) has mainly been designed for single drives. The setpoint speed for the drive is selected via the analog input X6/1. The signals are internally conditioned together with the digital control signals.

Short setup

The "Short setup" menu contains the following codes. In the "Short setup" menu of the XT keypad and "Global Drive Control", the codes are listed in the following order.

Code	Explanation	Lenze setting
C0005	Selection of the basic configuration	1000
C0010	Minimum speed	Reference value for the absolute and relative setpoint selection for the acceleration and deceleration times
C0011	Maximum speed	
C0012	Acceleration time T_{ir} of the main setpoint	5.00 s
C0013	Deceleration time T_{if} of the main setpoint	5.00 s
C0034	Voltage / current range for analog signals at the input X6/1, X6/2	0
C0104	Selection of acceleration function of the linear ramp-function generator of NSET	0
C0038/1 ... C0038/6	Suppressing the speed ranges, function block NLM1	0
C0039/1	JOG setpoints for the speed setpoint conditioning, function block NSET	1500 rpm
C0190	Arithmetic function, function block NSET Connects main setpoint (C0046) and additional setpoint (C0040)	0
C0220	Acceleration time T_{ir} for additional setpoint, function block NSET	2.00 s
C0221	Deceleration time T_{if} for additional setpoint, function block NSET	2.00 s
C0105	Quick stop deceleration time	5.00 s
C0909	Speed limitation, function block MCTRL	1
C0026/1	Offset of AIN1 (X6/1, X6/2)	0.00 %
C0026/2	Offset of AIN2 (X6/3, X6/4)	0.00 %
C0027/1	Gain AIN1 (X6/1, X6/2)	100.00 %
C0027/2	Gain AIN2 (X6/3, X6/4)	100.00 %
C0006	Selection of the operating mode for the motor control	5
C0025	Speed feedback	1
C0019	Operating threshold - automatic DC injection brake (Auto-GSB)	0 rpm
C0036	Set continuous brake current	0.0 A
C0107	Hold time for automatic DC injection braking (Auto-GSB)	0.00 s
C0142	Start conditions for flying restart circuit	1
C0145	Selection of flying restart method	1
C0070	Speed controller gain	10.0
C0071	Adjustment time of speed controller	50 ms
C0074	Limitation of the speed controller	10.00 %
C0077	Adjustment time of field controller	4.0 ms
C0898	Torque limitation in the field weakening range, function block MCTRL	0
C0472/3	Free control code for analog signals	100.00%
C0017	Q_{min} switching threshold	50 rpm

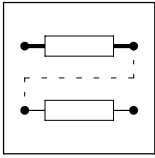

Configuration

Basic configuration

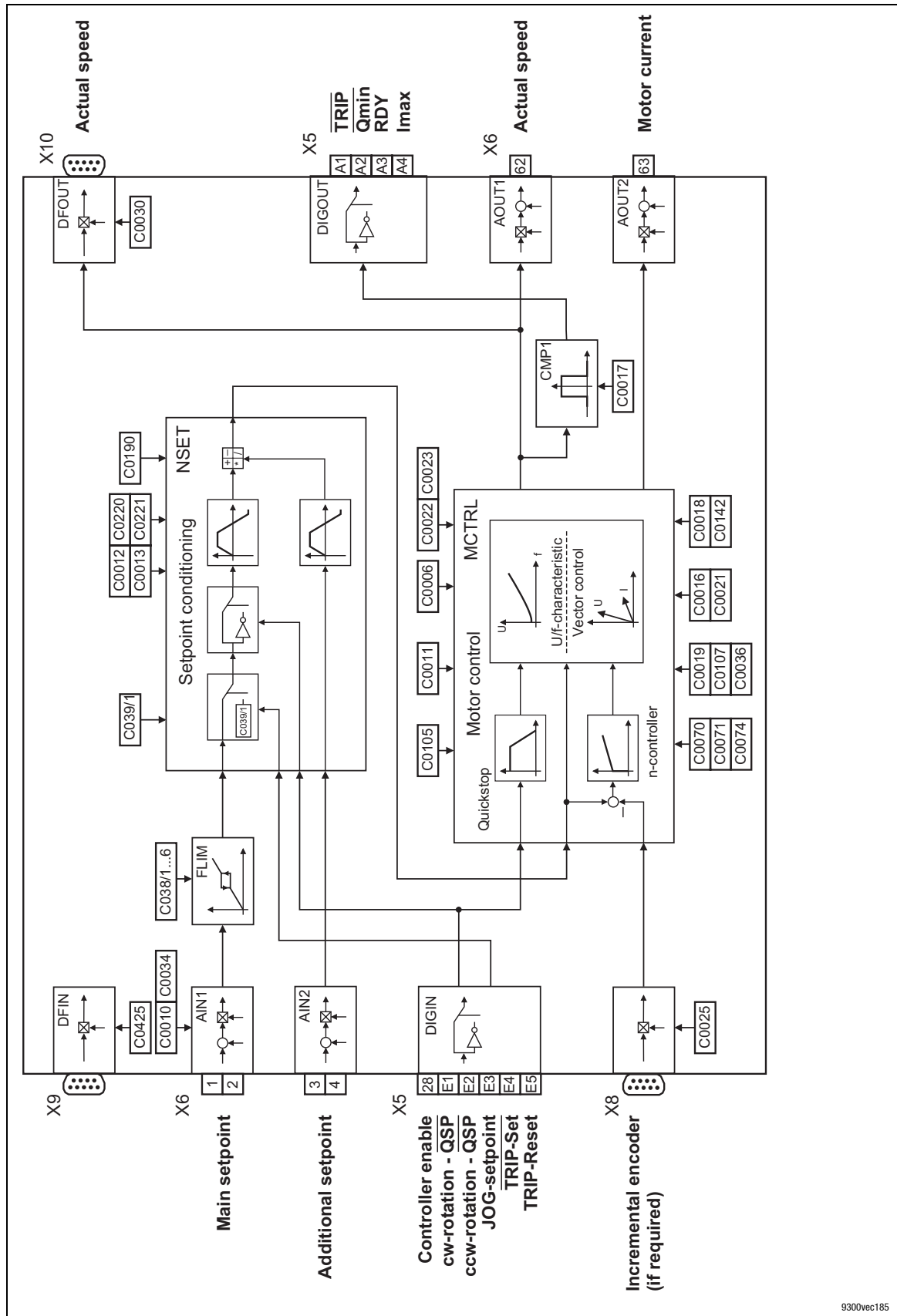
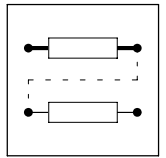

Fig. 2-1 Signal flow for configuration 1000: Speed control

9300vec185



2.2.4 Step control (C0005 = 2000)

The configuration C0005 = 2000 supports applications in which the drive should repeatedly turn a specific number of revolutions. This type of application is used for example to move unit loads on a conveyor belt or for dosing specific amounts repeatedly on worm conveyors.

The conveyor speed and path or dosing speed and amount are controlled independently of one another via the two analog inputs. The execution of a step is started via the digital input X5/E4.

Short setup

The "Short setup" menu contains the following codes. In the "Short setup" menu of the XT keypad and "Global Drive Control", the codes are listed in the following order.

Code	Explanation	Lenze setting
C0005	Selection of the basic configuration	2000
C0010	Minimum speed	Reference value for the absolute and relative setpoint
C0011	Maximum speed	selection for the acceleration and deceleration times
C0012	Acceleration time T_{ir} of the main setpoint	1.00 s
C0013	Deceleration time T_{if} of the main setpoint	1.00 s
C0034	Voltage / current range for analog signals at the input X6/1, X6/2	0
C0104	Selection of acceleration function of the linear ramp-function generator of NSET	0
C1350	Function selection, function block INT1	0
C1351	Scaling factor, function block INT1	6553600 inc
C0560/1	Internal path setpoint (fixed setpoint), function block FIXSET1	100.00 %
C0940	Adaptation of the braking distance	$[C0940] = \frac{[C0011] \cdot [C013] \cdot 65536}{120 \cdot [1351]}$
C0941		C0940 = 1 C0941 = 4
C0105	Quick stop deceleration time	5.00 s
C0019	Operating threshold - automatic DC injection brake (Auto-GSB)	0 rpm
C0036	Set continuous brake current	0.0 A
C0107	Hold time for automatic DC injection braking (Auto-GSB)	0.00 s
C0026/1	Offset of AIN1 (X6/1, X6/2)	0.00 %
C0026/2	Offset of AIN2 (X6/3, X6/4)	0.00 %
C0027/1	Gain AIN1 (X6/1, X6/2)	100.00 %
C0027/2	Gain AIN2 (X6/3, X6/4)	100.00 %

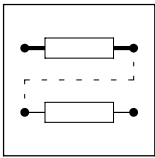

Configuration

Basic configuration

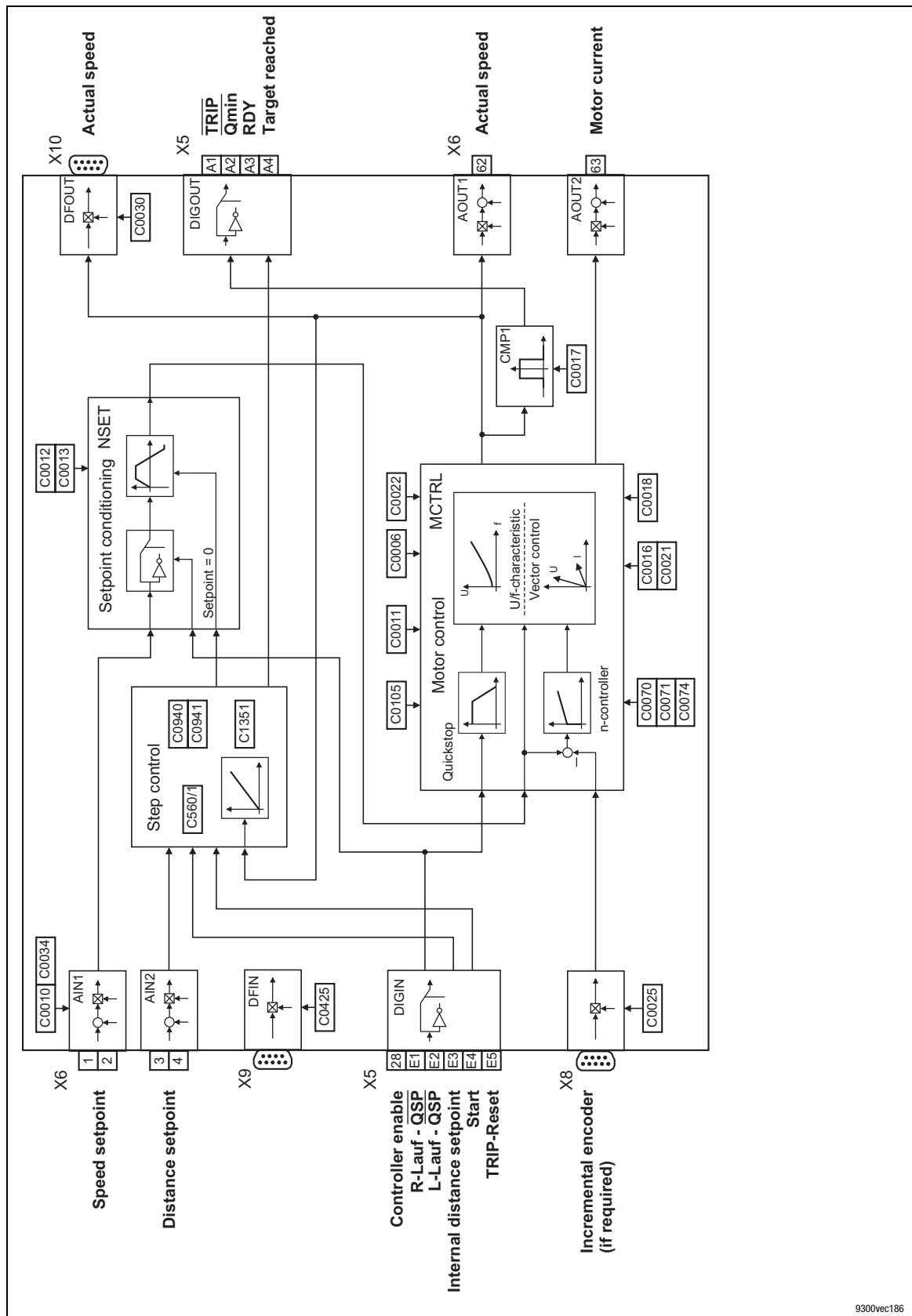

9300vec186

Fig. 2-2 Signal flow for configuration 2000: Step control

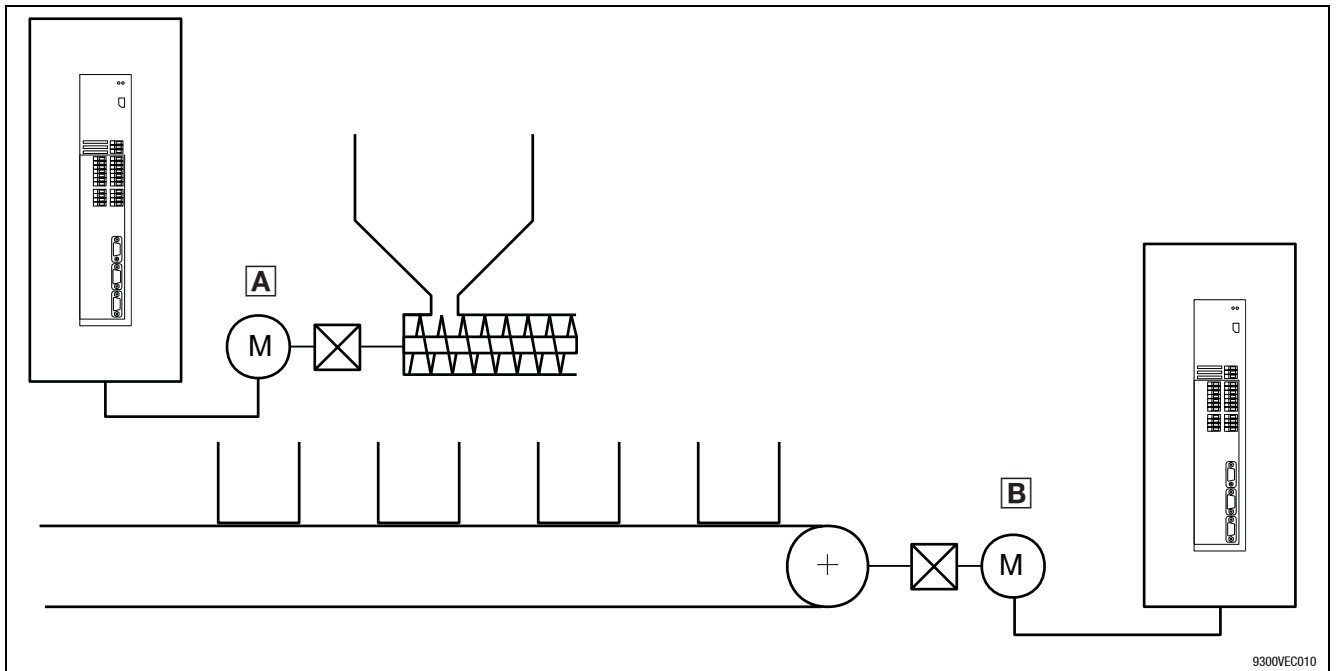
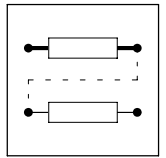

9300VEC010

Fig. 2-3 Basic structure of a step controller for a bulk material filling station

- A** Dosing drive
- B** Conveyor drive

Input and output assignment	Dosing drive	Conveyor drive
Analog inputs	<ul style="list-style-type: none"> • Dosing speed • Dosing amount 	<ul style="list-style-type: none"> • Conveyor speed • Step width
Digital inputs	<ul style="list-style-type: none"> • Controller enable • Direction of rotation • Defined dosing amount • Start dosing • TRIP reset 	<ul style="list-style-type: none"> • Controller enable • Step direction • Defined step width • Start step • TRIP reset
Digital outputs	<ul style="list-style-type: none"> • Error (TRIP) • Current speed > C0017 (Qmin) • Ready for operation (RDY) • Dosing completed 	<ul style="list-style-type: none"> • Error (TRIP) • Current speed > C0017 (Qmin) • Ready for operation (RDY) • Step completed
Analog outputs	<ul style="list-style-type: none"> • Actual speed • Motor current 	<ul style="list-style-type: none"> • Actual speed • Motor current

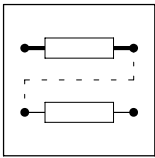

Configuration

Basic configuration

2.2.5 Traversing control (C0005 = 3000)

The configuration C0005 = 3000 is designed for spindle drives moving material by means of winding.

The speed of the winding drive is transferred via the analog input X6/1 which is used to control the speed of the traversing drive. The reversing of the direction of rotation is controlled via the digital inputs X5/E1 and X5/E2. Limit switches operating as normally closed contacts which disable the active direction of rotation can for example be used for this purpose.

Short setup

The "Short setup" menu contains the following codes. In the "Short setup" menu of the XT keypad and "Global Drive Control", the codes are listed in the following order.

Code	Explanation	Lenze setting
C0005	Selection of the basic configuration	3000
C0011	Maximum speed	Reference value for the absolute and relative setpoint selection for the acceleration and deceleration times
		3000 rpm
C0012	Acceleration time T_{ir} of the main setpoint	1.00 s
C0013	Deceleration time T_{if} of the main setpoint	1.00 s
C0034	Voltage / current range for analog signals at the input X6/1, X6/2	0
C0104	Selection of acceleration function of the linear ramp-function generator of NSET	2
C0141	Additional setpoint for inching, activated via input X5/E3	10.00 %
C0472/1	Selection of traversing step	100.00 %
C0474/1	Selection of traversing break (65536 results in a break of one motor revolution, if 100 % reference setpoint = 3000 rpm)	10000 inc
C0655	Numerator	Conversion factor, function block CONV5
		C0655 = 1
C0656	Denominator	
		C0656 = 5
C0190	Arithmetic function, function block NSET Connects main setpoint (C0046) and additional setpoint (C0040)	0
C0105	Quick stop deceleration time	5.00 s
C0026/1	Offset of AIN1 (X6/1, X6/2)	0.00 %
C0026/2	Offset of AIN2 (X6/3, X6/4)	0.00 %
C0027/1	Gain AIN1 (X6/1, X6/2)	100.00 %
C0027/2	Gain AIN2 (X6/3, X6/4)	100.00 %
C0685	Comparison function, function block CMP2	1
C0686	Hysteresis for input signals, function block CMP2	0.00 %
C0687	Window for signal comparison, function block CMP2	0.00 %

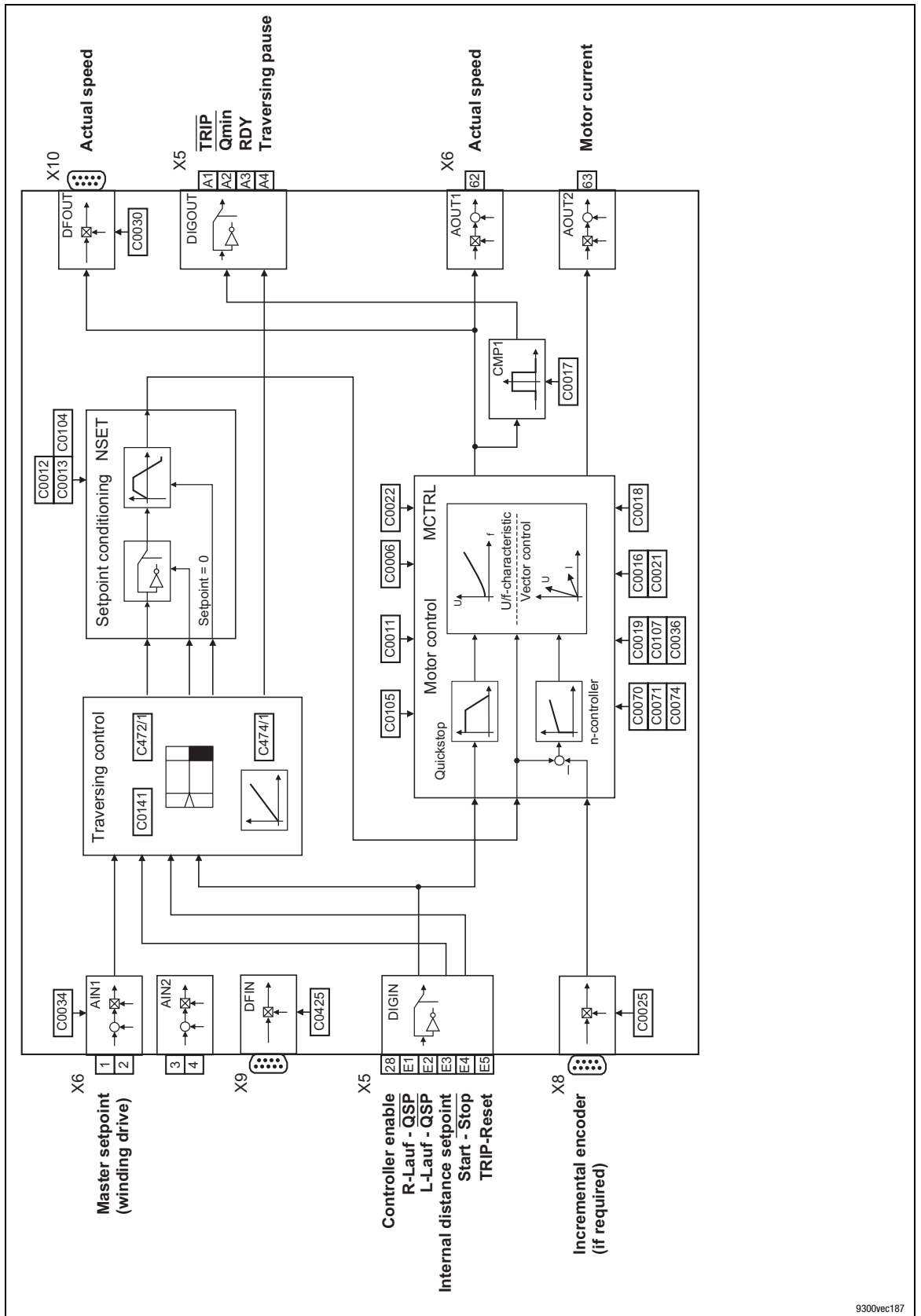
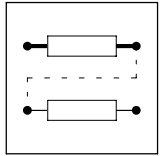
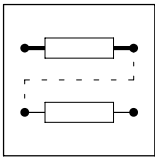

Fig. 2-4

Signal flow for configuration 3000: Traversing control

9300vec187



Configuration

Basic configuration

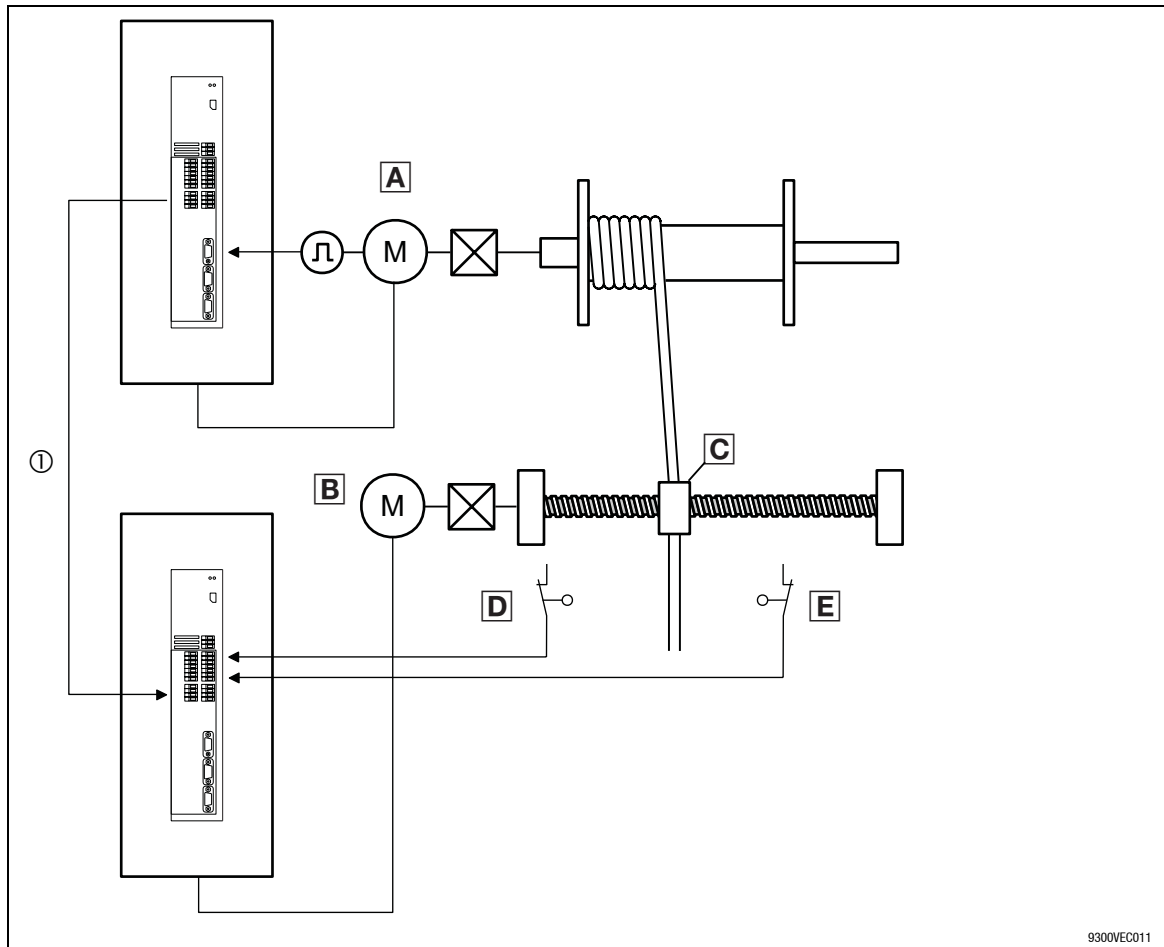

9300VEC011

Fig. 2-5 Basic structure of a traversing controller

- A** Winding drive
- B** Traversing drive
- C** Traversing unit
- D** Limit switch for CCW rotation
- E** Limit switch for CW rotation
- I** Reference setpoint (winding drive)

Input and output assignment	Traversing drive
Analog input	<ul style="list-style-type: none"> ● Reference setpoint
Digital inputs	<ul style="list-style-type: none"> ● Controller enable ● Direction of rotation ● Additional setpoint ● Start traversing ● TRIP reset
Digital outputs	<ul style="list-style-type: none"> ● Error (TRIP) ● Current speed > C0017 (Qmin) ● Ready for operation (RDY) ● Traversing break
Analog outputs	<ul style="list-style-type: none"> ● Actual speed value ● Motor current

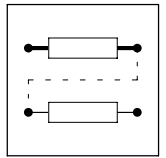

2.2.6 Torque control (C0005 = 4000)

Configuration C0005 = 4000 is designed for drive control via a torque setpoint.

The setpoint is selected via the analog input X6/2. The torque direction results from the sign of the setpoint and the control of the digital inputs X5/E1 and X5/E2. The maximum permissible speed is selected via the analog input X6/1.

Short setup

The "Short setup" menu contains the following codes. In the "Short setup" menu of the XT keypad and "Global Drive Control", the codes are listed in the following order.

Code	Explanation	Lenze setting
C0005	Selection of the basic configuration	4000
C0010	Minimum speed	Reference value for the absolute and relative setpoint selection for the acceleration and deceleration times 0 rpm
C0011	Maximum speed	
C0012	Acceleration time T_{if} of the main setpoint	5.00 s
C0013	Deceleration time T_{if} of the main setpoint	5.00 s
C0034	Voltage / current range for analog signals at the input X6/1, X6/2	0
C0039/1	JOG setpoints for the speed setpoint conditioning, function block NSET	1500 rpm
C0105	Quick stop deceleration time	5.00 s
C0909	Speed limitation, function block MCTRL	1
C0026/1	Offset of AIN1 (X6/1, X6/2)	0.00 %
C0026/2	Offset of AIN2 (X6/3, X6/4)	0.00 %
C0027/1	Gain AIN1 (X6/1, X6/2)	100.00 %
C0027/2	Gain AIN2 (X6/3, X6/4)	100.00 %
C0006	Selection of the operating mode for the motor control	5
C0022	I_{max} limit in motor mode	depends on the controller
C0023	I_{max} limit in generator mode	depends on the controller
C0025	Speed feedback	1
C0070	Speed controller gain	10.0
C0071	Adjustment time of speed controller	50 ms
C0074	Limitation of the speed controller	10.00 %
C0898	Torque limitation in the field weakening range, function block MCTRL	0
C0472/3	Free control code for analog signals	100.00 %
C0017	Q_{min} switching threshold (FCODE)	50 rpm

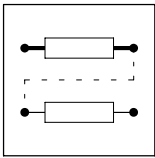

Configuration

Basic configuration

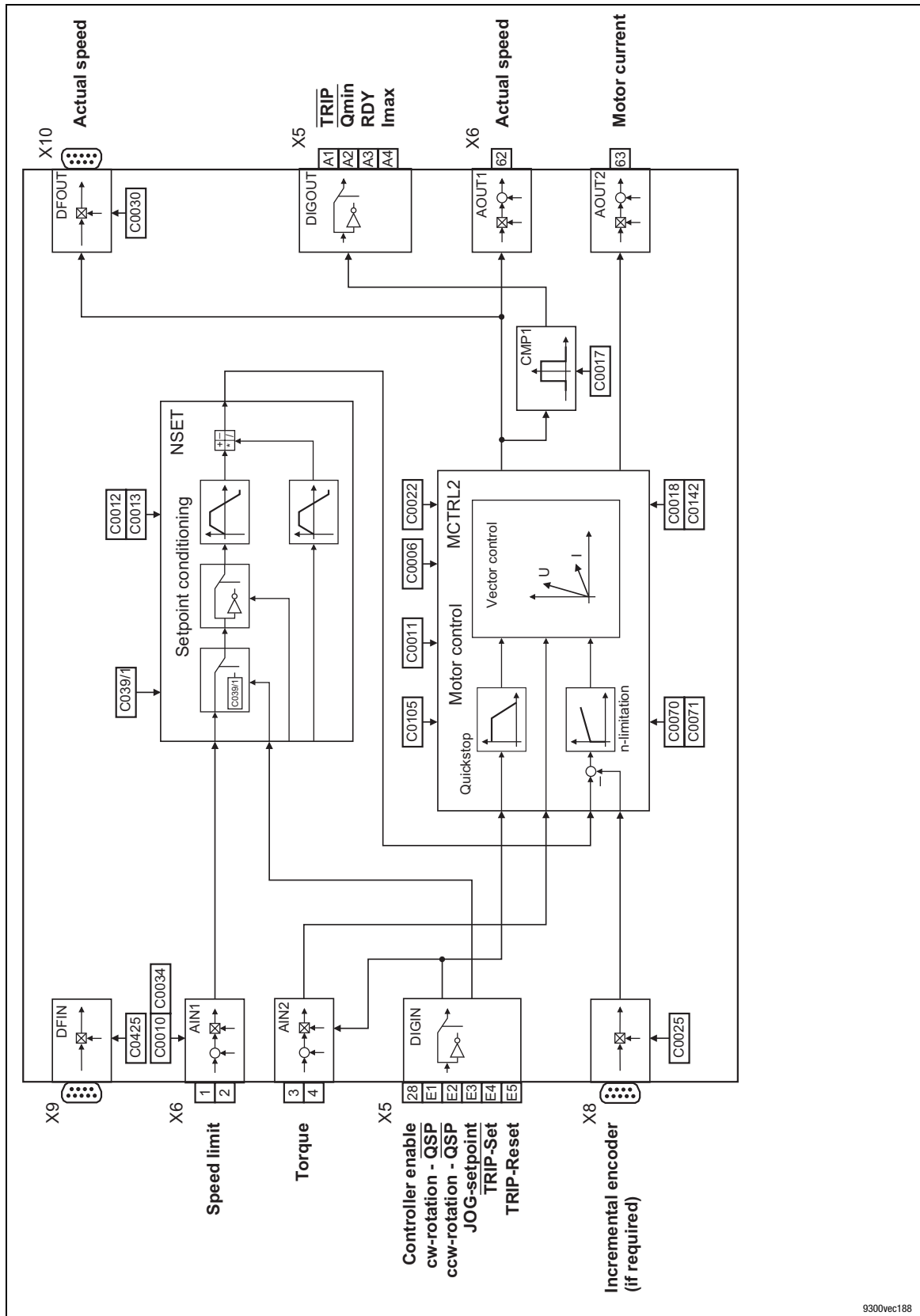
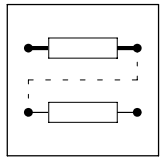

Fig. 2-6 Signal flow for configuration 4000: Torque control

9300vec188



2.2.7 Digital frequency - master (C0005 = 5000)

The configuration C0005 = 5000 is used to control a drive system. Both the master and the slave drives use the preprocessed speed setpoint as a common reference value. The speed setpoint is forwarded to the slave drives via digital frequency output X10.

The parameterisation of the evaluation of the reference value allows you to adapt the speed ratio of every single drive to the process.

Fig. 2-10 shows the basic structure of a digital frequency network for textile machinery.

Short setup

The "Short setup" menu contains the following codes. In the "Short setup" menu of the XT keypad and "Global Drive Control", the codes are listed in the following order.

Code	Explanation	Lenze setting
C0005	Selection of the basic configuration	5000
C0010	Minimum speed	Reference value for the absolute and relative setpoint selection for the acceleration and deceleration times
C0011	Maximum speed	
C0012	Acceleration time T_{ir} of the main setpoint	5.00 s
C0013	Deceleration time T_{if} of the main setpoint	5.00 s
C0034	Voltage / current range for analog signals at the input X6/1, X6/2	0
C0039/1	JOG setpoints for speed setpoint conditioning, function block NSET	1500 rpm
C0190	Arithmetic function, function block NSET Connects main setpoint (C0046) and additional setpoint (C0040)	0
C0220	Acceleration time T_{ir} for additional setpoint, function block NSET	2.00 s
C0221	Deceleration time T_{if} for additional setpoint, function block NSET	2.00 s
C0105	Quick stop deceleration time	5.00 s
C0909	Speed limitation, function block MCTRL	1
C0026/1	Offset of AIN1 (X6/1, X6/2)	0.00 %
C0026/2	Offset of AIN2 (X6/3, X6/4)	0.00 %
C0027/1	Gain AIN1 (X6/1, X6/2)	100.00 %
C0027/2	Gain AIN2 (X6/3, X6/4)	100.00 %
C0473/1	Numerator	Digital frequency signal evaluation, function block DFSET
C0533	Denominator	
C0530	Setpoint integrator evaluation, function block DFSET	0
C0032	Numerator	Gearbox factor, function block DFSET
C0033	Denominator	
C0252	Phase offset for master frequency processing, function block DFSET	0 inc
C0253	Speed-dependent phase trimming for the master frequency processing, function block DFSET	18700 inc
C0531	Actual zero pulse divisor, function block DFSET	1
C0535	Desired zero pulse divisor, function block DFSET	1
C0532	Zero pulse / touch probe, function block DFSET	1
C0534	Zero pulse function, function block DFSET (drive synchronisation)	0
C0529	Offset multiplier, function block DFSET	1
C0472/5	Free control code for analog signals	0.00 %
C0473/3	Free control code for absolute analog signals	0
C0030	Constant for digital frequency output X10, function block DFOUT	3
C0540	Function selection, function block DFOUT	0
C0545	Phase offset, function block DFOUT	0 inc

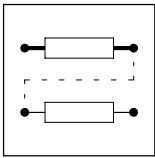

Configuration

Basic configuration

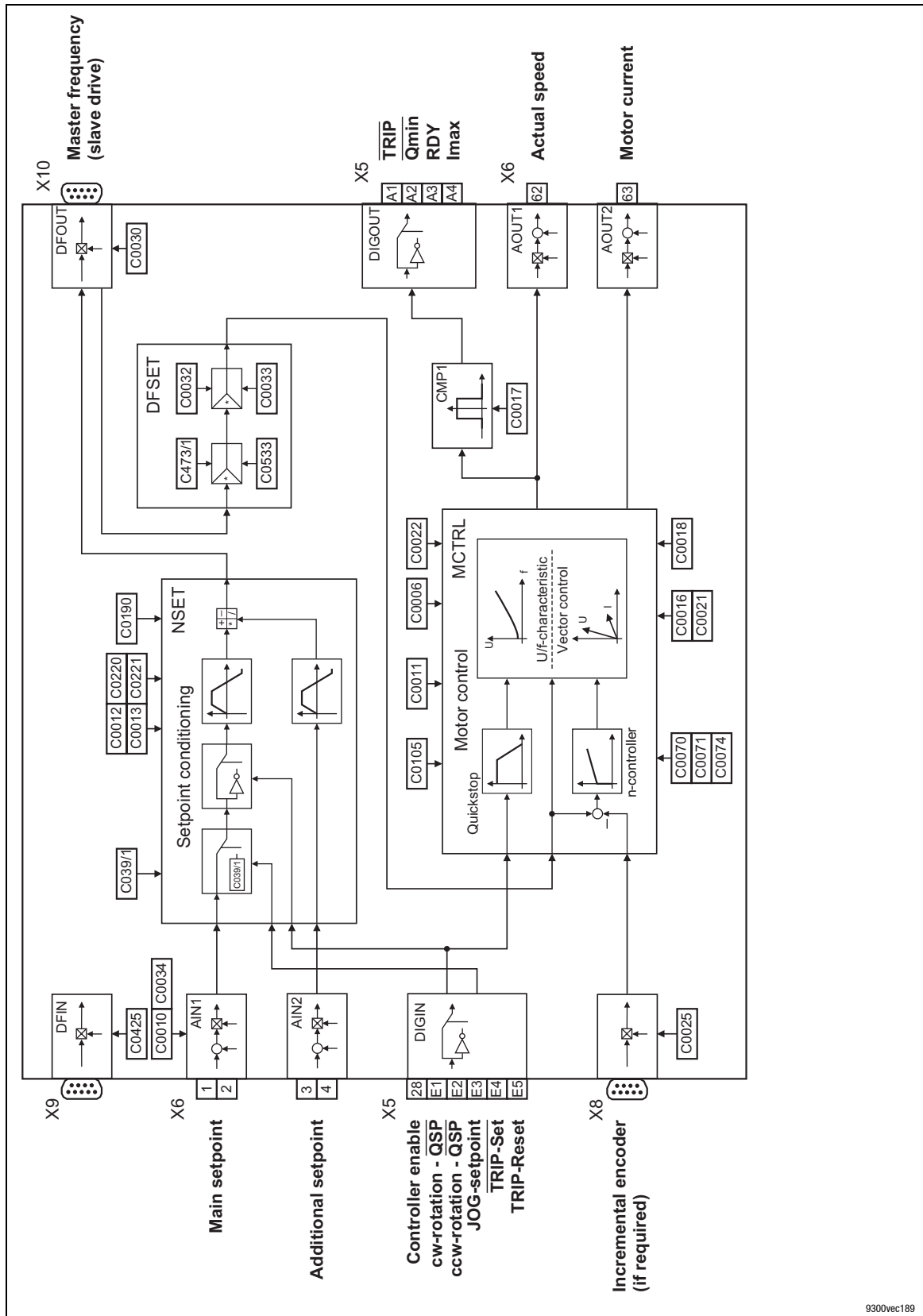

9300vec189

Fig. 2-7 Signal flow for configuration 5000: Digital frequency master

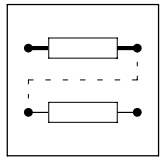

2.2.8 Digital frequency – slave (bus) (C0005 = 6000)

The configuration C0005 = 6000 is used to integrate the drive controller into a drive system.

The drive is controlled by reading in the digital frequency setpoint via input X9. This value is then evaluated and the speed of the drive is adapted to the process based on the result of the evaluation.

An internal additional setpoint can also be activated via digital input X5/E3.

The digital frequency setpoint is forwarded to the slave drives without being changed.

Fig. 2-10 shows the basic structure of a digital frequency network for textile machinery.

Short setup

The "Short setup" menu contains the following codes. In the "Short setup" menu of the XT keypad and "Global Drive Control", the codes are listed in the following order.

Code	Explanation	Lenze setting
C0005	Selection of the basic configuration	6000
C0011	Maximum speed	Reference value for the absolute and relative setpoint selection for the acceleration and deceleration times
C0105	Quick stop deceleration time	3000 rpm
C0141	Additional setpoint, activated via input X5/E3	5.00 s
C0671	Acceleration time T_{if} , function block RFG1	10.00 %
C0672	Deceleration time T_{if} , function block RFG1	5.00 s
C0425	Digital frequency input constant, function block DFIN	3
C0473/1	Numerator	Digital frequency signal evaluation, function block DFSET
C0533	Denominator	C0473/1 = 1
C0530	Setpoint integrator evaluation, function block DFSET	C0533 = 1
C0032	Numerator	0
C0033	Denominator	Gearbox factor, function block DFSET
C0252	Phase offset for master frequency processing, function block DFSET	C0032 = 1
C0253	Speed-dependent phase trimming for the master frequency processing, function block DFSET	C0033 = 1
C0531	Actual zero pulse divisor, function block DFSET	0 inc
C0535	Desired zero pulse divisor, function block DFSET	4000 inc
C0532	Zero pulse / touch probe, function block DFSET	1
C0534	Zero pulse function, function block DFSET (drive synchronisation)	1
C0529	Offset multiplier, function block DFSET	0
C0472/5	Free control code for analog signals	1
C0473/3	Free control code for absolute analog signals	0.00 %
C0030	Constant for digital frequency output X10, function block DFOUT	0
C0540	Function selection, function block DFOUT	3
C0545	Phase offset, function block DFOUT	4
		0 inc

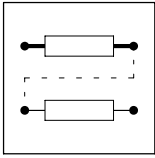

Configuration

Basic configuration

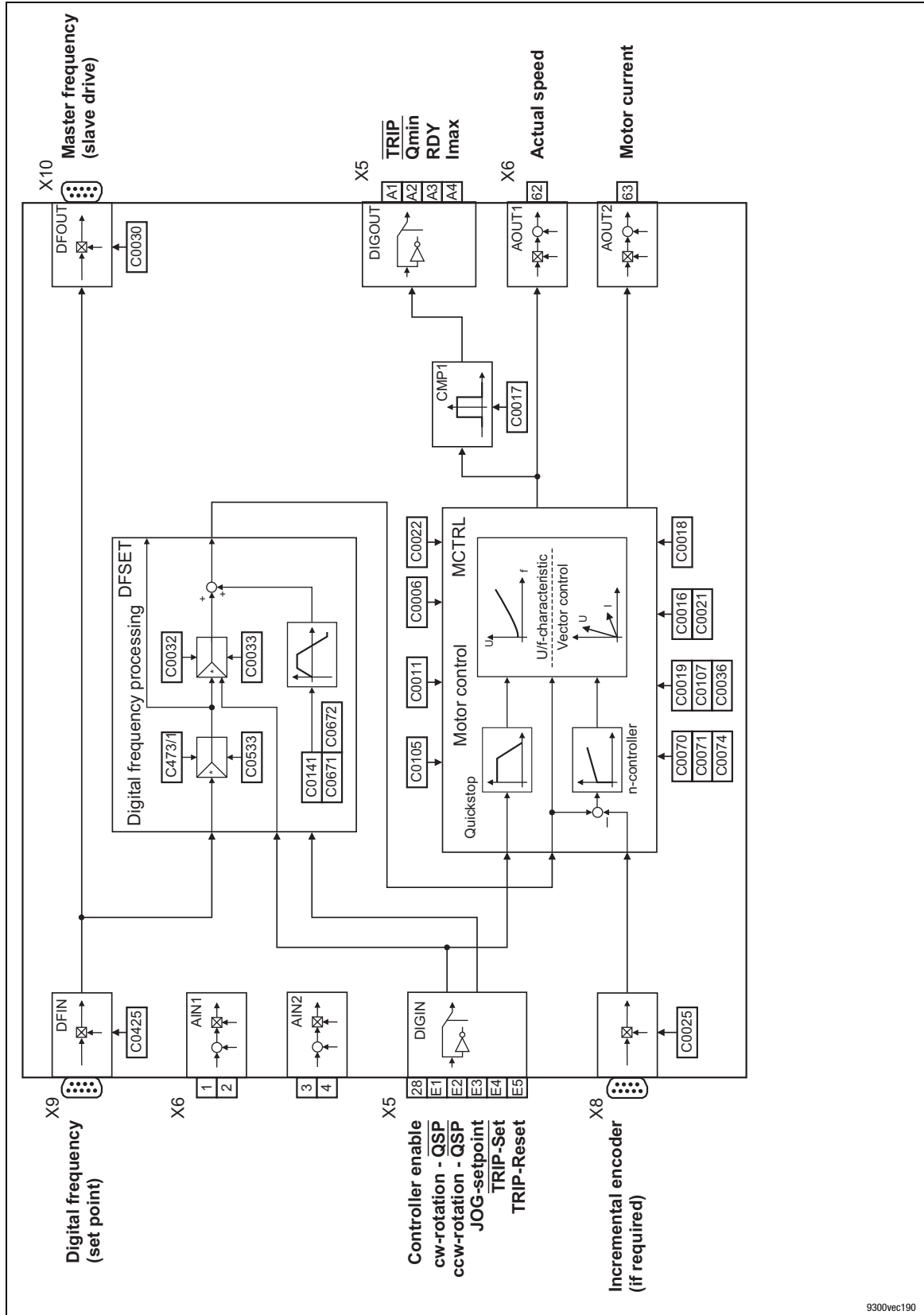
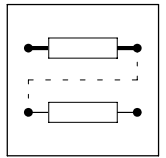

Fig. 2-8 Signal flow for configuration 6000: Digital frequency slave (bus)

9300vec190



2.2.9 Digital frequency – slave (cascade) (C0005 = 7000)

The configuration C0005 = 7000 is used to integrate the drive controller into a drive system.

The drive is controlled by reading in the digital frequency setpoint via input X9. This value is then evaluated and the speed of the drive is adapted to the process based on the result of the evaluation.

An internal additional setpoint can also be activated via digital input X5/E3.

Unlike in configuration 6000, the evaluated control setpoint is forwarded via digital frequency output X10. This means that changes in the evaluation also affect subsequent drives.

Fig. 2-10 shows the basic structure of a digital frequency network for textile machinery.

Short setup

The "Short setup" menu contains the following codes. In the "Short setup" menu of the XT keypad and "Global Drive Control", the codes are listed in the following order.

Code	Explanation	Lenze setting
C0005	Selection of the basic configuration	7000
C0011	Maximum speed	Reference value for the absolute and relative setpoint selection for the acceleration and deceleration times
C0105	Quick stop deceleration time	3000 rpm
C0141	Additional setpoint, activated via input X5/E3	5.00 s
C0671	Acceleration time T_{if} , function block RFG1	10.00 %
C0672	Deceleration time T_{if} , function block RFG1	5.00 s
C0425	Digital frequency input constant, function block DFIN	3
C0473/1	Numerator	Digital frequency signal evaluation, function block DFSET
C0533	Denominator	C0473/1 = 1
C0530	Setpoint integrator evaluation, function block DFSET	C0533 = 1
C0032	Numerator	Gearbox factor, function block DFSET
C0033	Denominator	C0032 = 1
C0252	Phase offset for master frequency processing, function block DFSET	C0033 = 1
C0253	Speed-dependent phase trimming for the master frequency processing, function block DFSET	0 inc
C0531	Actual zero pulse divisor, function block DFSET	4000 inc
C0535	Desired zero pulse divisor, function block DFSET	1
C0532	Zero pulse / touch probe, function block DFSET	1
C0534	Zero pulse function, function block DFSET (drive synchronisation)	0
C0529	Offset multiplier, function block DFSET	1
C0472/5	Free control code for analog signals	0.00 %
C0473/3	Free control code for absolute analog signals	0
C0540	Function selection, function block DFOUT	1



Note!

In this configuration, incremental encoder input X8 cannot be activated.

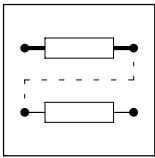

Configuration

Basic configuration

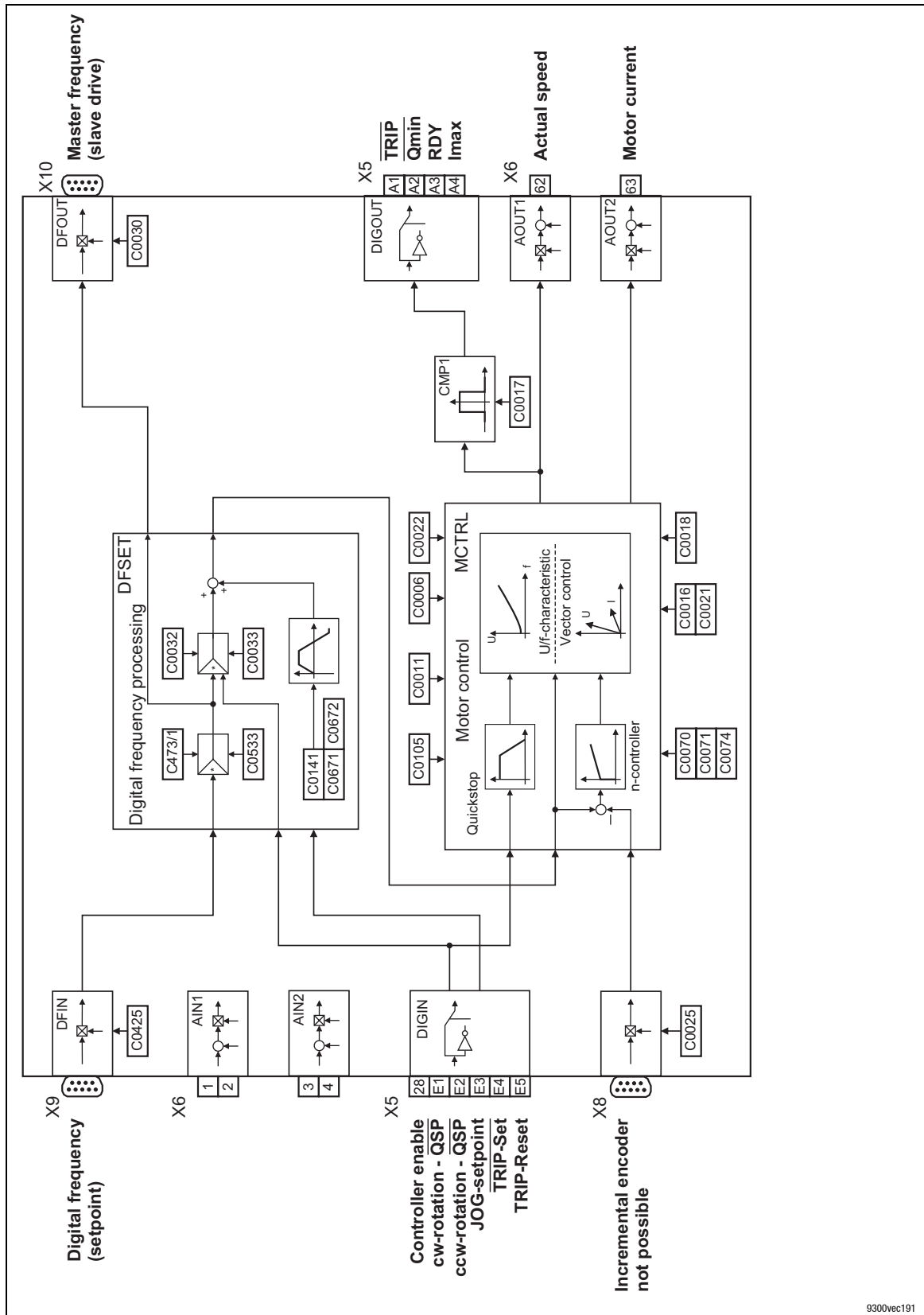

9300vec191

Fig. 2-9 Signal flow for configuration 7000: Digital frequency slave (cascade)

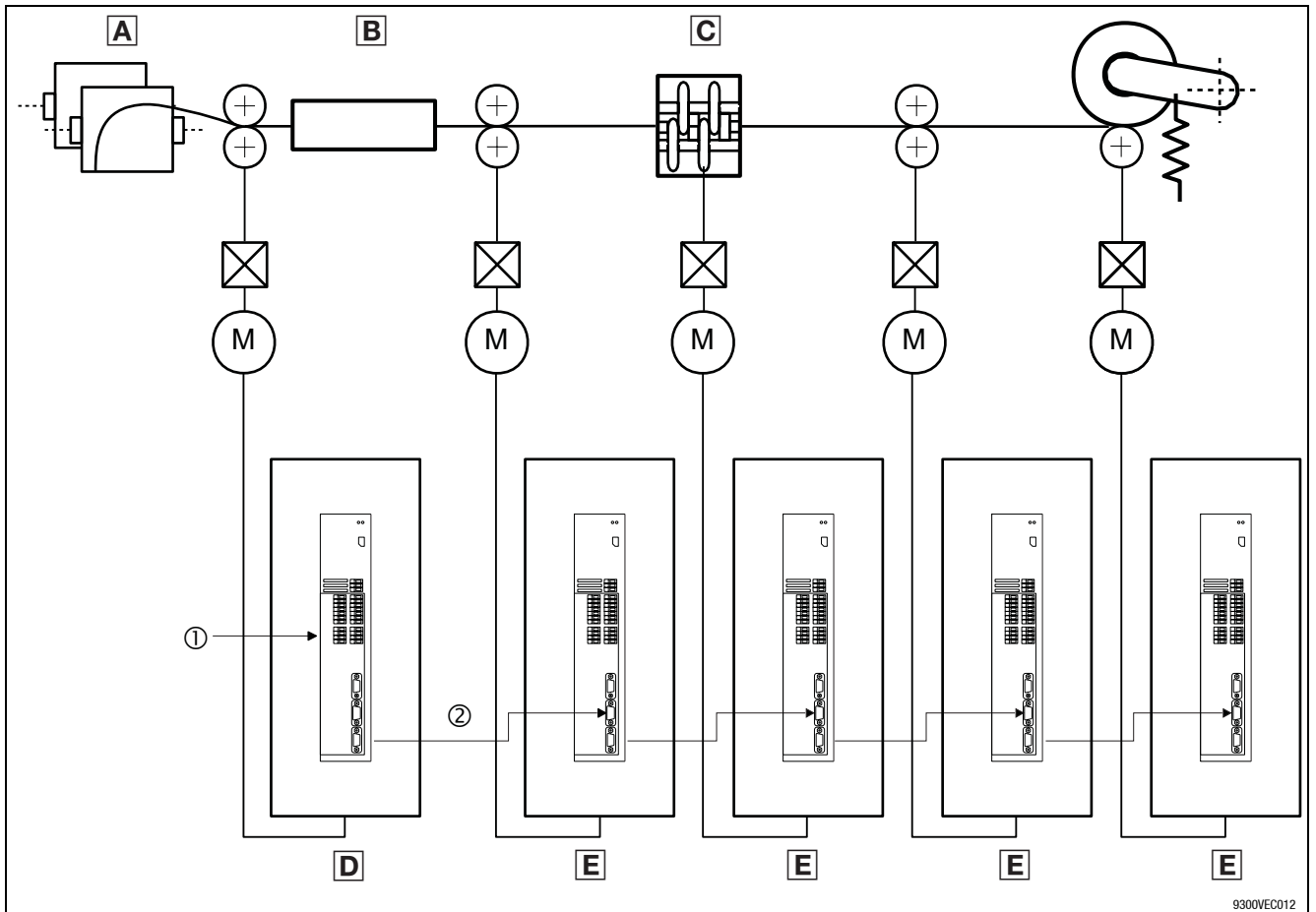
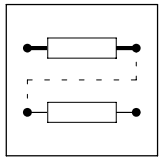

9300VEC012

Fig. 2-10 Basic structure of a digital frequency network for textile machinery

- A** Raw material
- B** Warm-up
- C** Napping
- D** Main drive, digital frequency master
- E** Slave drive, digital frequency slave (bus/cascade)
- ① Main setpoint
- ② Digital frequency

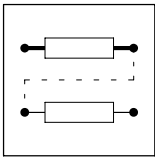

Configuration

Basic configuration

2.2.10 Dancer position control with external diameter detection (C0005 = 8000)

The configuration C0005 = 8000 is designed for winding drives with dancer position control and external diameter detection.

A digital frequency signal is sent for precontrolling the drive with the system/material speed. On the basis of the actual position of the dancer, the dancer position controller generates a correction signal which is added to the precontrol signal. This results in a circumferential speed setpoint which, in the case of a surface winder, can be applied directly as the speed setpoint.

On a centre winding machine, the speed setpoint is obtained by evaluating the reel diameter. The analog signal generated by the diametrical sensor is preprocessed accordingly inside the controller.

Short setup

The "Short setup" menu contains the following codes. In the "Short setup" menu of the XT keypad and "Global Drive Control", the codes are listed in the following order.

Code	Explanation	Lenze setting
C0005	Selection of the basic configuration	8000
C0011	Maximum speed Reference value for the absolute and relative setpoint selection for the acceleration and deceleration times	3000 rpm
C0034	Voltage / current range for analog signals at the input X6/1, X6/2	0
C0425	Digital frequency input constant, function block DFIN	3
C0427	Digital frequency input function, function block DFIN	0
C0141	Dancer position setpoint	10.00 %
C1330	Acceleration time t_{if} , function block PCTRL2	1.0 s
C1331	Deceleration time t_{if} , function block PCTRL2	1.0 s
C1332	Gain V_p , function block PCTRL2	1.0
C1333	Integral-action time T_n , function block PCTRL2	400 ms
C1334	Differential component K_d , function block PCTRL2	0.0
C1335	Sphere of action, function block PCTRL2	0
C1336	Fade-in time, function block PCTRL2	0.1 s
C1337	Fade-out time, function block PCTRL2	0.1 s
C0472/1	Influence, function block PCTRL2	10.00 %
C0026/1	Offset of AIN1 (X6/1, X6/2)	0.00 %
C0026/2	Offset of AIN2 (X6/3, X6/4)	0.00 %
C0027/1	Gain AIN1 (X6/1, X6/2)	100.00 %
C0027/2	Gain AIN2 (X6/3, X6/4)	100.00 %

Configuration

Basic configuration

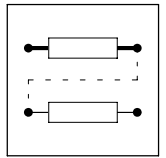

Code	Explanation	Lenze setting
C1300	Motor speed at D_{max} , function block DCALC1	300 rpm
C1301	Maximum line speed, function block DCALC1	3000 rpm
C1302	Calculation cycle, function block DCALC1	0.1 rev
C1303	Filter time constant, function block DCALC1	0.10 s
C1304	Maximum diameter, function block DCALC1	500 mm
C1305	Lower diameter limit, function block DCALC1	100 mm
C1306	Upper diameter limit, function block DCALC1	500 mm
C1307	Hysteresis - diameter limitation, function block DCALC1	1.00 %
C1308	Selection of the arithmetic function, function block DCALC1	1
C1309	Minimum diameter, function block DCALC1	100 mm
C1310	Acceleration and deceleration time, function block DCALC1	1.000 s
C1311	Permissible diameter difference, function block DCALC1	1.00 %
C1328	Display of current diameter, function block DCALC1	0 mm
C0105	Quick stop deceleration time	5.00 s
C0640	Time constant, function block PT1-1	1.00 s
C0685	Comparison function, function block CMP2	1
C0686	Hysteresis for input signals, function block CMP2	1.00 %
C0687	Window for signal comparison, function block CMP2	1.00 %
C0720	Function, function block DIGDEL1	2
C0721	Delay time, function block DIGDEL1	0.100 s
C0950	Numerator for digital frequency evaluation	5
C0951	Denominator for digital frequency evaluation	1
C0017	Q_{min} switching threshold	50 rpm



Note!

In this configuration, incremental encoder input X8 can be activated by selecting output input signal at X8 (C0540 = 5) for digital frequency output X10.

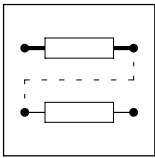

Configuration

Basic configuration

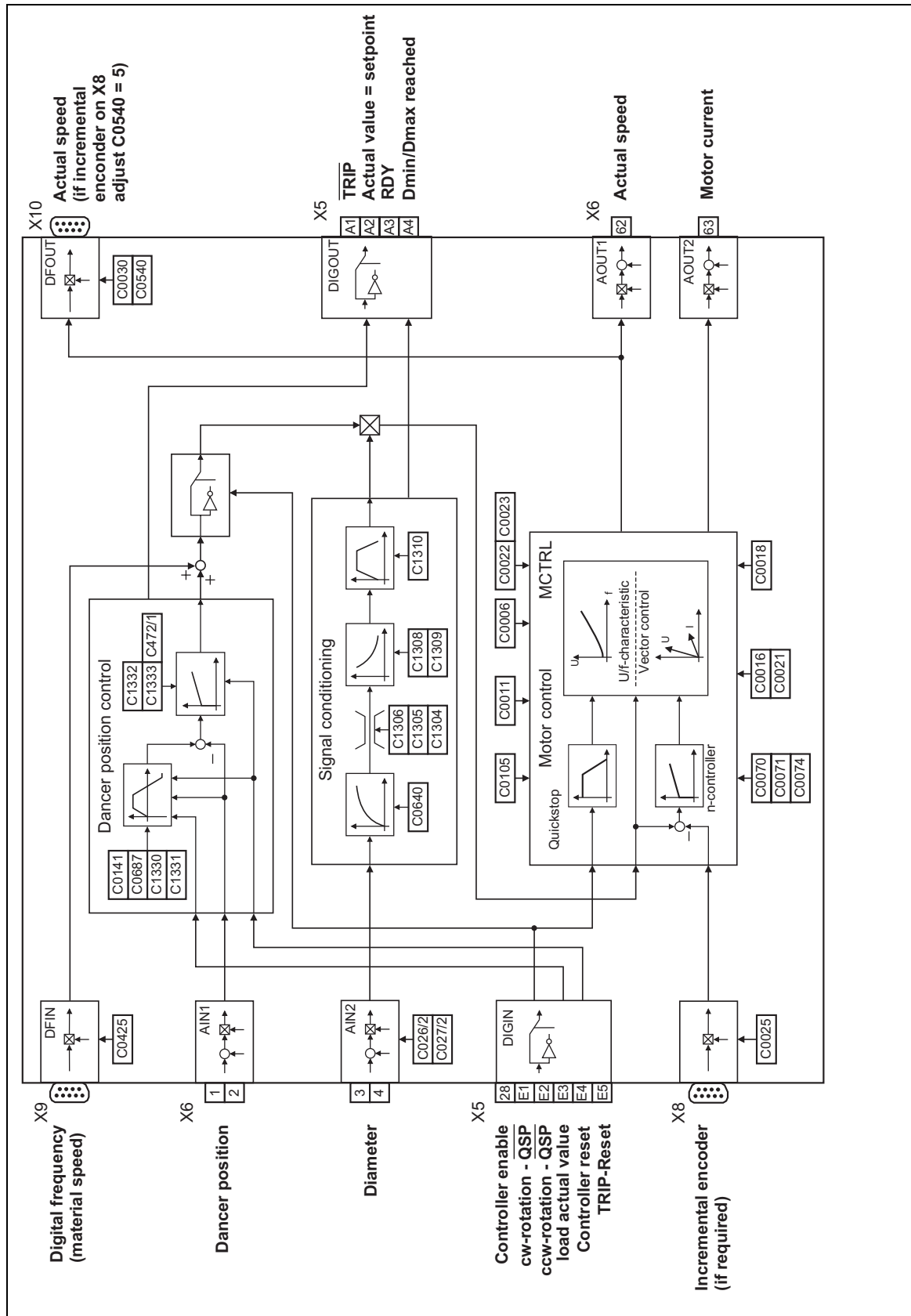
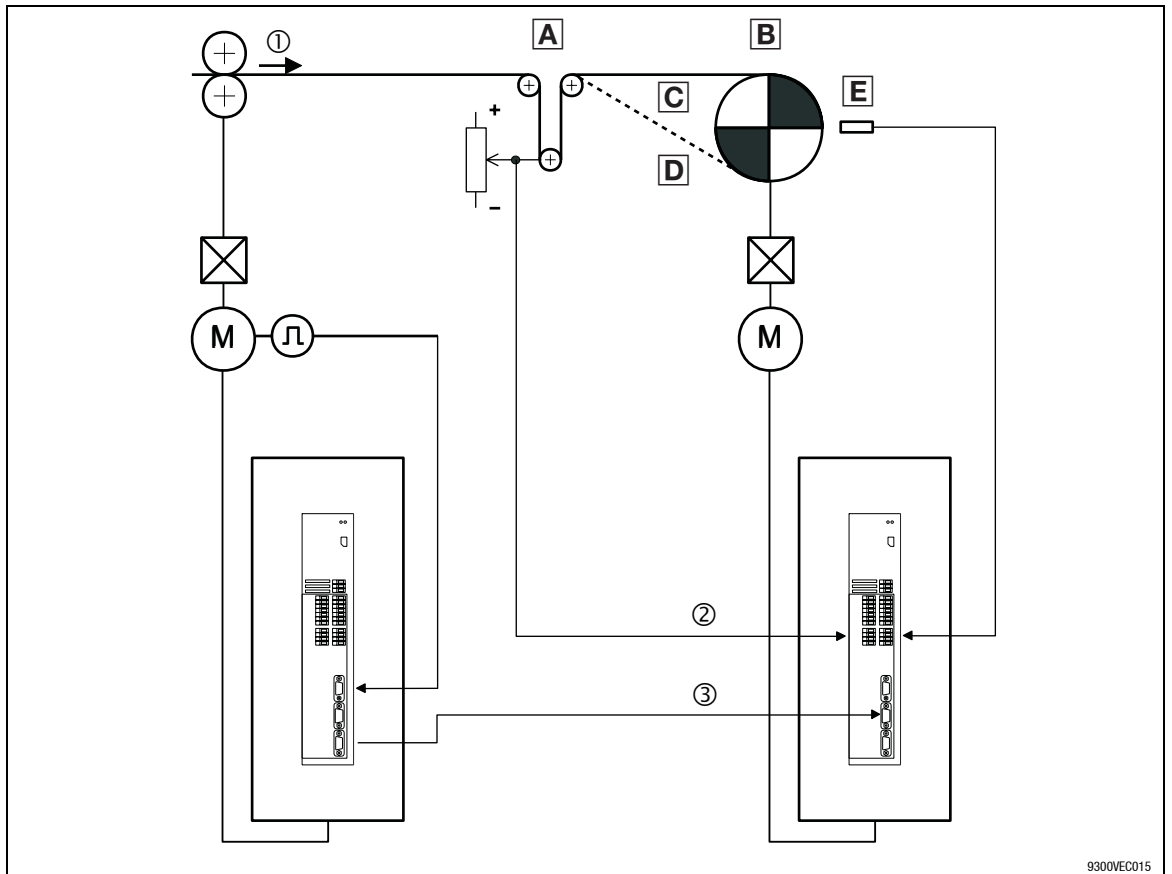
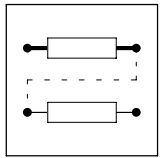

Fig. 2-11

Signal flow for configuration 8000: Dancer position control (external diameter detection)



9300VEC015

Fig. 2-12

Basic structure of a dancer position control with external diameter detection via a diametrical sensor

- A** Dancer
- B** Winder
- C** CW rotation
- D** CCW rotation
- E** Diametrical sensor
- ① Line speed V_{Line}
- ② Dancer position
- ③ Line speed

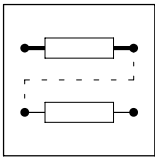

Configuration

Basic configuration

2.2.11 Dancer position control with internal diameter detection (C0005 = 9000)

The configuration C0005 = 9000 is designed for winding drives with dancer position control. Unlike configuration 8000, in this type of application, the diameter is calculated internally.

A digital frequency signal is sent for precontrolling the drive with the system/material speed. On the basis of the actual position of the dancer, the dancer position controller generates a correction signal which is added to the precontrol signal. This results in a circumferential speed setpoint which, when multiplied by 1/D, provides the speed setpoint.

The reel diameter is calculated using the signals for the line speed and the winding speed. Each time the reel changes, the new initial diameter can be loaded.

Short setup

The "Short setup" menu contains the following codes. In the "Short setup" menu of the XT keypad and "Global Drive Control", the codes are listed in the following order.

Code	Explanation	Lenze setting
C0005	Selection of the basic configuration	9000
C0011	Maximum speed Reference value for the absolute and relative setpoint selection for the acceleration and deceleration times	3000 rpm
C0034	Voltage / current range for analog signals at the input X6/1, X6/2	0
C0425	Digital frequency input constant, function block DFIN	3
C0427	Digital frequency input function, function block DFIN	0
C0141	Dancer position setpoint	10.00 %
C1330	Acceleration time t_{if} , function block PCTRL2	1.0 s
C1331	Deceleration time t_{if} , function block PCTRL2	1.0 s
C1332	Gain V_p , function block PCTRL2	1.0
C1333	Integral-action time T_n , function block PCTRL2	400 ms
C1334	Differential component K_d , function block PCTRL2	0.0
C1335	Sphere of action, function block PCTRL2	0
C1336	Fade-in time, function block PCTRL2	0.1 s
C1337	Fade-out time, function block PCTRL2	0.1 s
C0472/1	Influence, function block PCTRL2	10.00 %
C0026/1	Offset of AIN1 (X6/1, X6/2)	0.00 %
C0026/2	Offset of AIN2 (X6/3, X6/4)	0.00 %
C0027/1	Gain AIN1 (X6/1, X6/2)	100.00 %
C0027/2	Gain AIN2 (X6/3, X6/4)	100.00 %

Configuration

Basic configuration

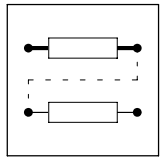

Code	Explanation	Lenze setting
C1300	Motor speed at D_{max} , function block DCALC1	500 rpm
C1301	Maximum line speed, function block DCALC1	2500 rpm
C1302	Calculation cycle, function block DCALC1	0.1 rev
C1303	Filter time constant, function block DCALC1	1.00 s
C1304	Maximum diameter, function block DCALC1	500 mm
C1305	Lower diameter limit, function block DCALC1	100 mm
C1306	Upper diameter limit, function block DCALC1	500 mm
C1307	Hysteresis - diameter limitation, function block DCALC1	1.00 %
C1308	Selection of the arithmetic function, function block DCALC1	1
C1309	Minimum diameter, function block DCALC1	100 mm
C1310	Acceleration and deceleration time, function block DCALC1	1.000 s
C1311	Permissible diameter difference, function block DCALC1	1.00 %
C1328	Display of current diameter, function block DCALC1	0 mm
C0105	Quick stop deceleration time	5.00 s
C0640	Time constant, function block PT1-1	1.00 s
C0685	Comparison function, function block CMP2	1
C0686	Hysteresis for input signals, function block CMP2	1.00 %
C0687	Window for signal comparison, function block CMP2	1.00 %
C0720	Function, function block DIGDEL1	2
C0721	Delay time, function block DIGDEL1	0.100 s
C0950	Numerator for digital frequency evaluation	5
C0951	Denominator for digital frequency evaluation	1
C0017	Q_{min} switching threshold	50 rpm



Note!

In this configuration, incremental encoder input X8 can be activated by selecting output input signal at X8 (C0540 = 5) for digital frequency output X10.

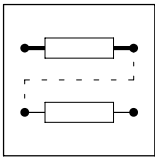

Configuration

Basic configuration

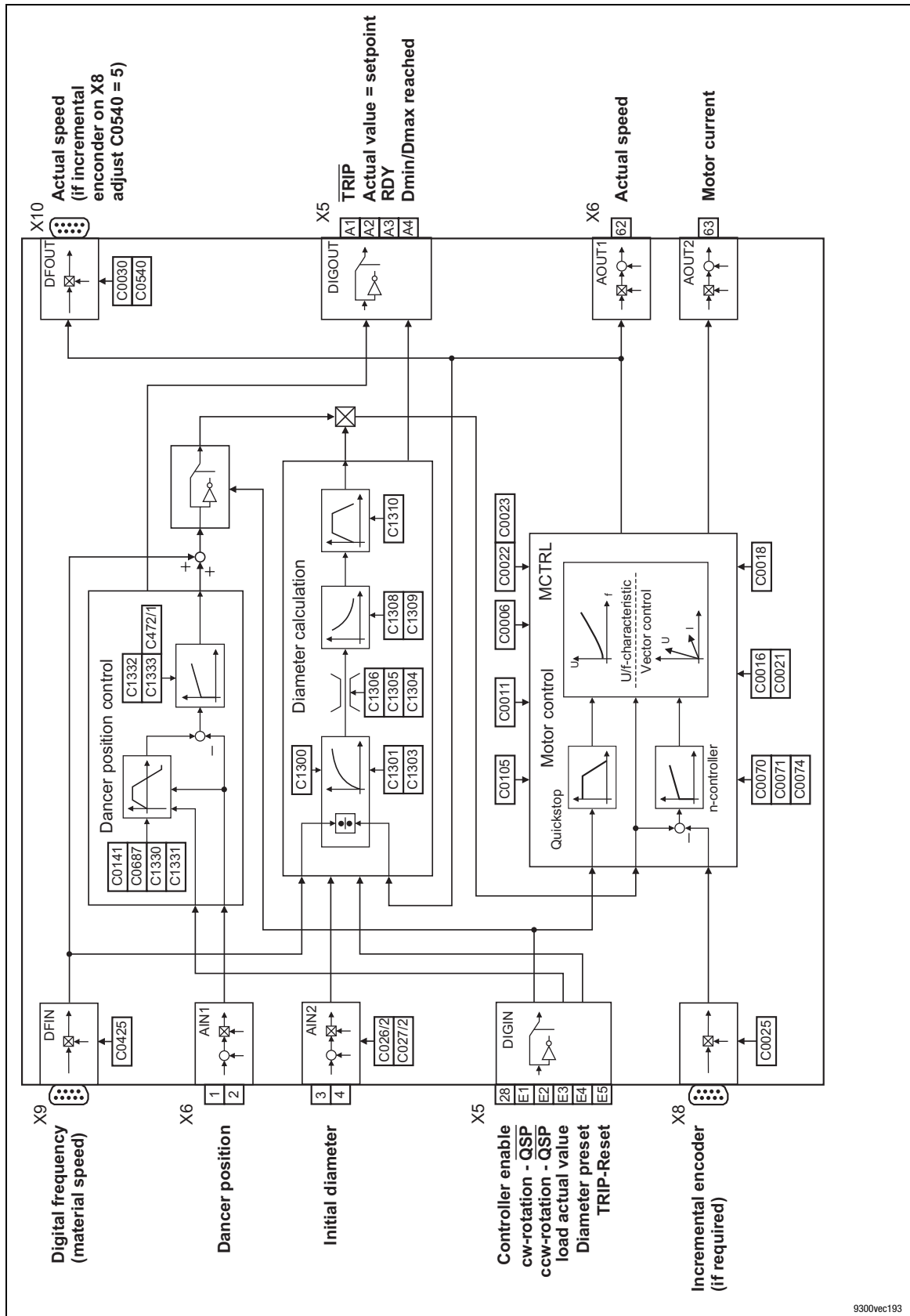

9300vec193

Fig. 2-13

Signal flow for configuration 9000: Dancer position control (internal diameter calculation)

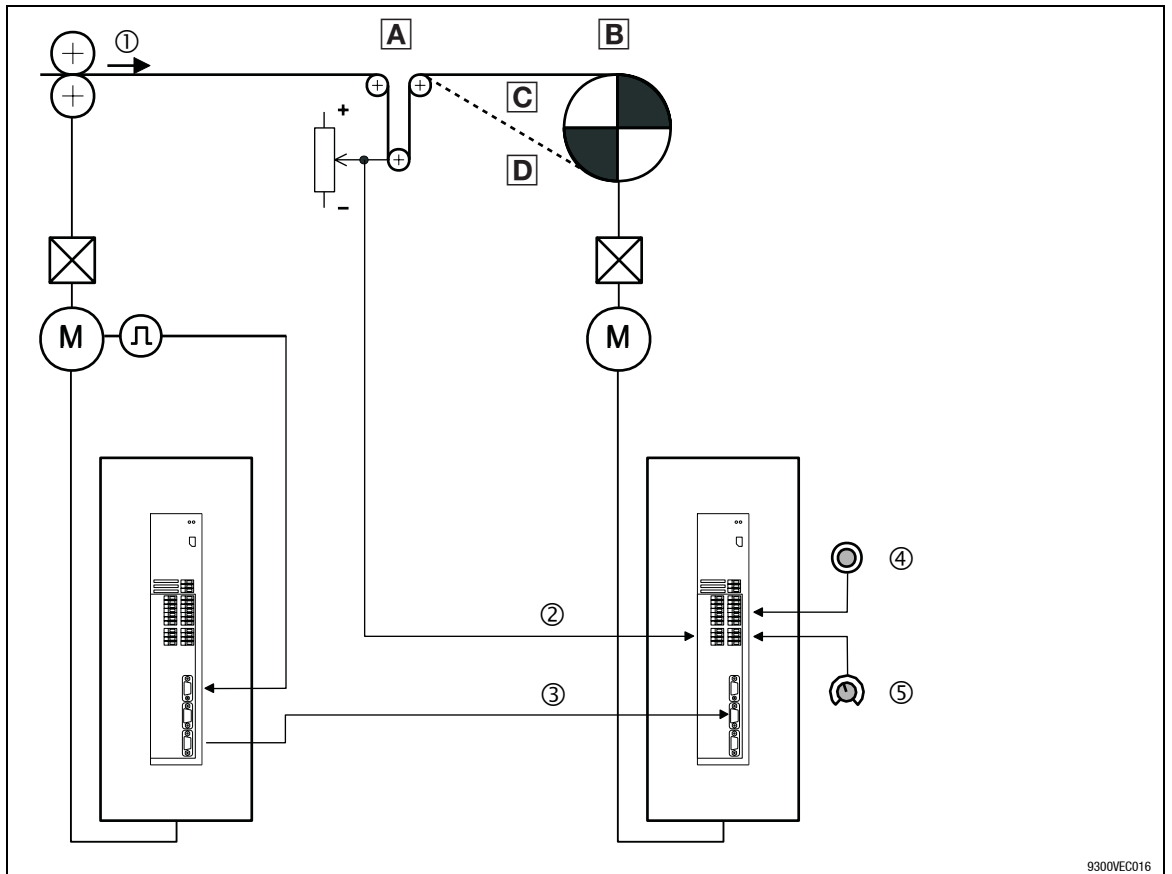
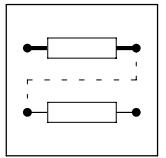
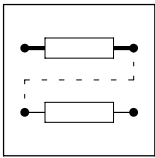

Fig. 2-14 Basic structure of a dancer controller with diameter calculation via the internal diameter calculator

- A** Dancer
- B** Winder
- C** CW rotation
- D** CCW rotation
- ① Line speed V_{Line}
- ② Dancer position
- ③ Line speed
- ④ Preset diameter
- ⑤ Initial diameter



Configuration

Use of funktion blocks

2.3 Use of function blocks

You can configure the signal flow in the controller yourself by interconnecting function blocks. This makes it easy to adapt the controller to different applications.

2.3.1 Signal types

Every function block has a specific number of inputs and outputs which can be connected to one another. The signal types occurring at the inputs and outputs depend on the individual functions:

- Quasi analog signals
 - Symbol: ○
 - Unit: %
 - Identification: a
 - Value range: $\pm 16384 = \pm 100\%$
 - Resolution: 16-bit, scaling $\pm 16384 \triangleq \pm 100\%$
- Digital signals
 - Symbol: □
 - Unit: binary, with HIGH or LOW level
 - Identification: d
 - Resolution: 1-bit
- Speed signals
 - Symbol: ▲
 - Unit: rpm (for display, internal representation in [inc/ms])
 - Identification: phd
 - Value range: $\pm 2^{15} - 1$
 - Resolution: 16-bit
- Phase signals
 - Symbol: ▲
 - Unit: inc
 - Identification: ph
 - Value range: $\pm 2^{31} - 1$
 - Resolution: 32-bit, scaling 1 revolution $\triangleq 65536$ inc

Only signals of the same type can be combined. I.e. an analog output signal of a function block can only be linked with the analog input of another function block. If you try to combine two different signal types, the combination will not be accepted.

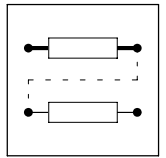

2.3.2 Function block elements

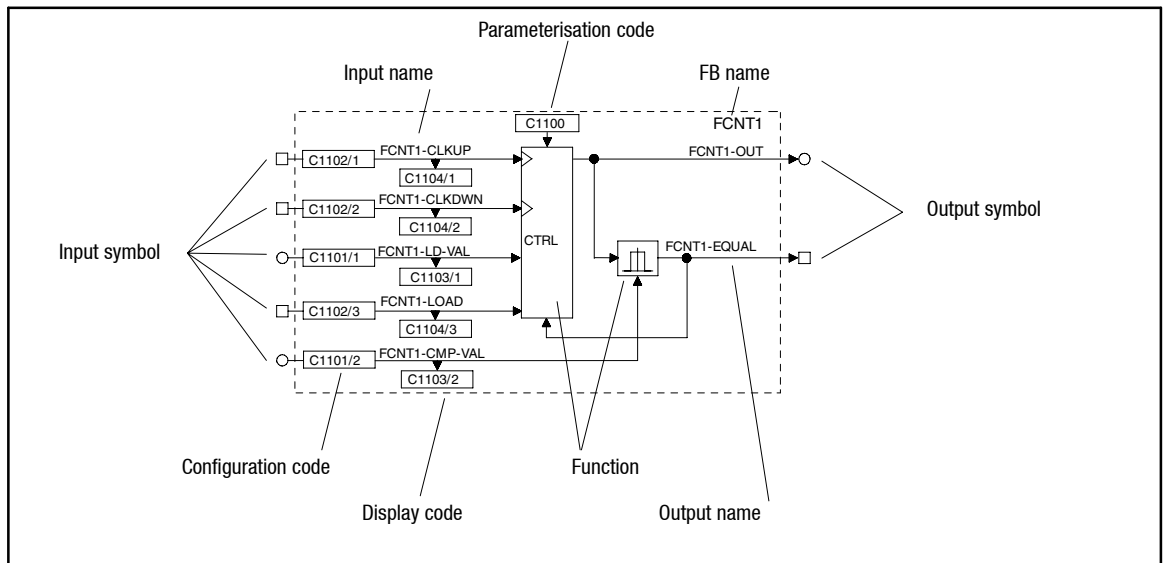

Fig. 2-15 Example: Structure of function block (FB) FCNT1

FB name

Unambiguously identifies the FB. Several FBs with the same function are distinguished by a number following the name.

Every FB is defined by means of a selection number. For calculating the FB, the selection number must be entered into the processing table. (2-41)

The selection numbers are listed in selection list 5.

Example:

(FCNT1, see Fig. 2-15)

- FCNT1 $\underline{\Delta}$ selection number 6400 (selection list 5).

Input symbol

Indicates the signal type permitted as signal source at the input. (2-34)



Note!

You can only configure inputs which are led out of the FB.

Input name

Consists of the FB name and a designation. Inputs with the same function are distinguished by a number following the designation.

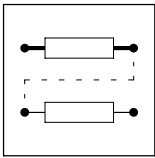

Configuration

Use of funktion blocks

Configuration code

Configures the input with a signal source (e. g. terminal signal, control code, FB output, ...). Inputs with the same code are distinguished by their subcode. The subcode is added to the code (Cxxx/1). These codes are configured via the subcode.

Every input can only be connected to one signal source.

Display code

Indicates the current input value. Inputs with the same code are distinguished by their subcode. The subcode is added to the code (Cxxx/1). These codes are displayed via the subcode.

Display codes cannot be edited.

Function

Shows the mathematical function as a block diagram (see Fig. 2-15).

Parameterisation code

Adapts the function and the behaviour to the drive task. The possible settings are described in the text and/or in line charts. (☞ 2-43)

Output symbol

Indicates the signal type. Connections with inputs of the same signal type are possible. (☞ 2-34)

Every output is defined via a selection number. The selection numbers are listed in selection lists (1 ... 4) corresponding to the different signal types.

The selection numbers are used to connect the outputs with inputs.

Example:

(FCNT1, see Fig. 2-15)

- FCNT1-OUT \triangle selection number 6400 (analog signal, selection list 1).
- FCNT1-EQUAL \triangle selection number 6400 (digital signal, selection list 2).



Note!

You can only configure outputs which are led out of the FB.

Output name

Consists of the FB name and a designation. Outputs with the same function are distinguished by a number following the designation.

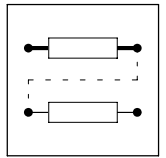

2.3.3 Connecting function blocks

General rules

- To every input a signal source is assigned.
- Every input can only have one signal source.
- Inputs of different function blocks can have the same signal source.
- Only identical signal types can be combined.



Stop!

Existing connections that are not wanted must be reconfigured and removed. Otherwise, the drive may execute functions that are not desired.



Note!

Lenze provides a network list generator for the visualisation of existing connections.

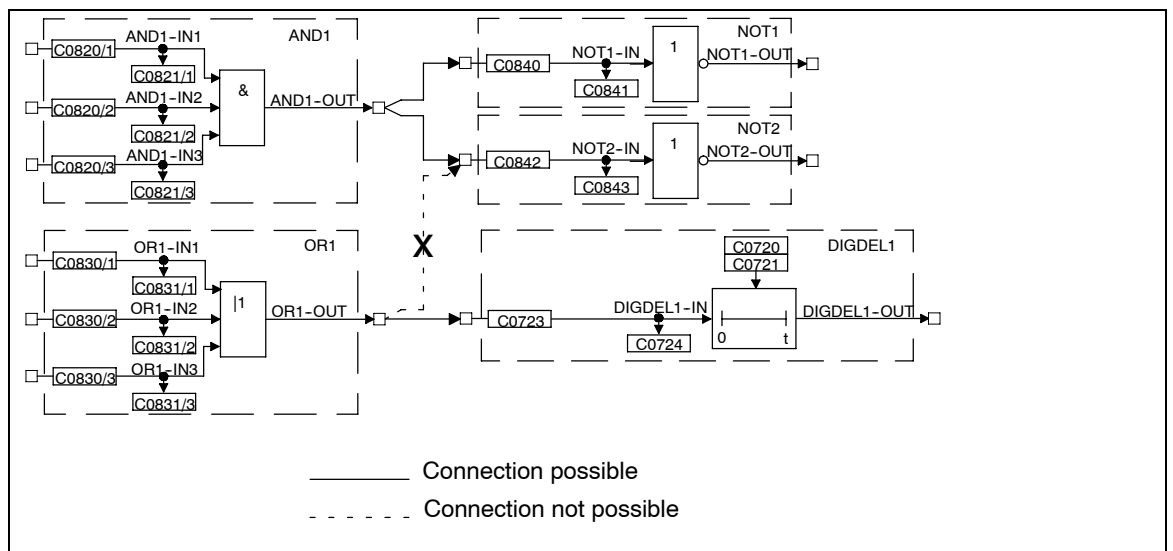
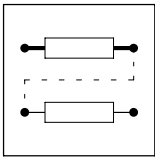

Fig. 2-16

Correct connection of function blocks



Configuration

Use of funktion blocks

Basic procedure

1. Select the configuration code of the function block input to be changed.
2. Where do you want the input signal for the selected input to come from? (e.g. from the output of another function block).
3. A menu which only contains signal sources of the same type as the function block input to be assigned is used to assign the function block input.
4. Select and confirm the signal source.
5. Remove connections that are not desired, if necessary.
 - For this, use the configuration code and select a corresponding input signal assignment (e.g. FIXED0, FIXED1, FIXED0%, ...).
6. Repeat steps 1 to 5 until the desired configuration has been created.
7. Save the new configuration in the desired parameter set.

Example

- Condition:
 - Default setting
- Task:
 - Square the analog signal of X6/3, X6/4 and output it at X6/62.
- Solution:
 - You need the function blocks AIN2, ARIT2 and AOUT2.

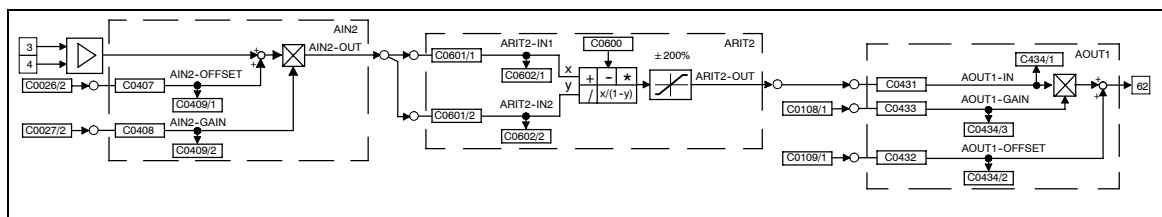
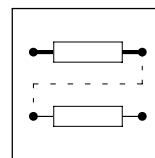

Fig. 2-17

Example of a simple configuration



Building up connections

1. Determine the signal source for ARIT2-IN1:
 - Use the arrow keys and go to the code level.
 - Use **▲** or **▼** to select C0601/1.
 - Press PRG to go to the parameter level.
 - Use **▲** or **▼** to select the output AIN2-OUT (selection number 55).
 - Confirm with SH + PRG.
 - Press PRG to go back to the code level.
2. Determine the signal source for ARIT2-IN2:
 - Use **▲** to select C0601/2.
 - Press PRG to go to the parameter level.
 - Use **▲** or **▼** to select the output AIN2-OUT (selection number 55).
 - Confirm with SH + PRG.
 - Press PRG to go back to the code level.
3. Parameterise ARIT2:
 - Use **▼** to select C0600.
 - Press PRG to go to the parameter level.
 - Select multiplication (selection number 3).
 - Confirm with SH + PRG.
 - Press PRG to go back to the code level.
4. Determine the signal source for AOUT1:
 - Use **▼** to select C0431.
 - Press PRG to go to the parameter level.
 - Select output ARIT2-OUT (selection number 5505).
 - Confirm with SH + PRG.
 - Press PRG to go back to the code level.
5. Enter function block ARIT2 into the processing table:
 - Use **▲** to select C0465 and subcode 8.
 - Press PRG to go to the parameter level.
 - Enter function block ARIT2 (selection number 5505).
 - Confirm with SH + PRG.
 - Press PRG to go back to the code level.
 - This determines the order of FB processing.

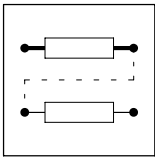

Configuration

Use of funktion blocks

Removing connections

- Since a source may have several targets, there may be additional signal connections, which may under certain conditions not be wanted.
- Example:
 - In the default setting of the basic configuration C0005 = 1000 (speed control) ASW1-IN1 and AIN2-OUT are connected.
 - The above-taken steps do not automatically deactivate this connection! If the connection is not desired, it must be removed.

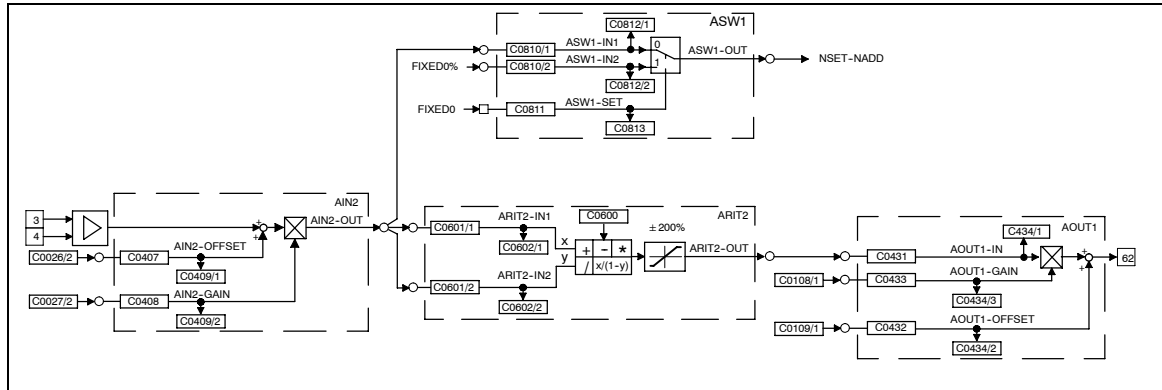

Fig. 2-18

Removing connections in a configuration

6. Remove the connection between ASW1-IN1 and AIN2-OUT:
 - Use **▲** or **▼** to select C0810/1
 - Press PRG to go to the parameter level.
 - Use **▲** or **▼** to select the constant FIXED0% (selection number 1000).
 - Confirm with SH + PRG.
 - Press PRG to go back to the code level.

The connection has now been removed.

7. Save the new configuration, if necessary:
 - Use C0003 and save the new signal configuration in a parameter set to ensure that the changes will not get lost after mains switching.

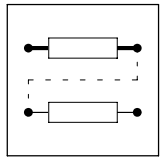

2.3.4 Entries in the processing table

The 93XX controller provides a certain computing time for FB processing. Since type and number of the FBs used may vary in the individual applications, the controller does not continuously calculate all FBs available. Under code C0465 you can find a processing table which contains only the FBs that are used in the application. In this way, the drive system is ideally adapted to the application. If additional FBs are added to an existing configuration, they must be entered into the processing table.

For the entry, the following points must be observed:

The number of FBs to be processed is limited

Every configuration can contain maximally 50 FBs. Every FB needs a certain processing time (run time). Code C0466 indicates the remaining process time for FB processing. When the process time is used up, you cannot add any further FBs.

Order of FB entries

In general, the entries under C0465 can be made in any order. However, with highly dynamic drive tasks, the order of the entries may be important. Usually, we recommend to adapt the order of the entries to the signal flow.

Example:

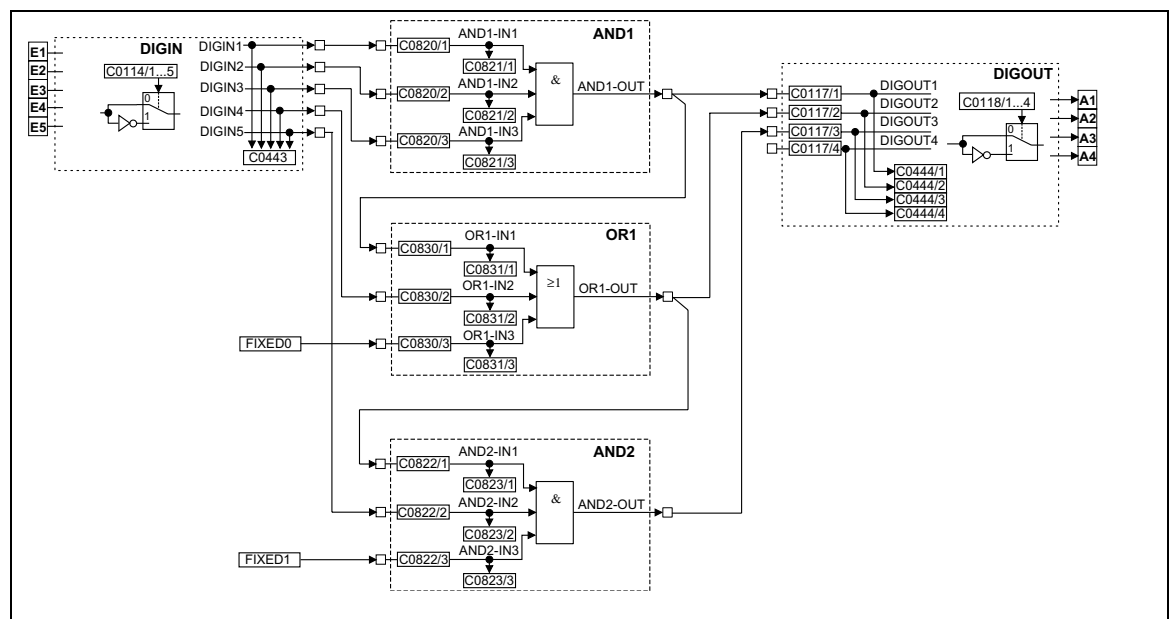
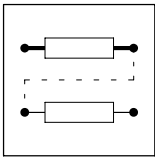

Fig. 2-19 Configuration example

Structure of the processing table for the configuration example in Fig. 2-19:

1. DIGIN need not be entered into the processing table.
2. AND1 is the first FB because it receives its input signals from DIGIN and only has successors.
3. OR1 is the second FB because its signal source is the output of AND1 (predecessor). I.e. the output signal in AND1 must first be generated before it can be processed in OR1. OR1 also has a successor. I.e. OR1 must be entered before its successor in the processing table.



Configuration

Use of funktion blocks

4. AND2 is the third FB because it has a predecessor (see 3.)
5. Accordingly, the entries under C0465 are as follows:
 - Position 10: AND1 10500
 - Position 11: OR1 10550
 - Position 12: AND2 10505

The example starts with position 10 because these positions have not been assigned with the default setting.

The FBs need not be entered directly one after the other in the processing table. Empty positions are permitted.



Note!

Other FBs may be entered between the FBs used in the example.

FBs which need not be entered into the processing table

The following signal sources are always executed. This is why they need not be entered into the processing table:

- AIF-IN
- CANx-IN
- DIGIN
- DIGOUT
- FCODE (all free codes)
- MCTRL
- fixed signal sources (FIXED0, FIXED0%, etc.)

Frequent configuration errors

Error	Cause	Remedy
FB sends no output signal	FB has not been entered into the processing table under C0465	Enter FB into the processing table
FB only sends constant signals	FB has been removed from the processing table or overwritten	Enter FB again into the processing table, if necessary, under a different subcode (position)
The following FB does not receive the output signal	No connection between the FBs	Build up connection (seen from the subsequent FB's view) under the configuration code (CFG)
FB cannot be entered into the table under C0465	Not enough process time available (see C0466)	Remove FBs which are not used, if any (e.g. inputs and outputs which are not used) With DC bus connections, some functions may be transferred to other controllers, if necessary
Controller transmits internal signals with delay to the outputs	FB processing order is not correct	Adapt the processing table to the signal flow under C0465

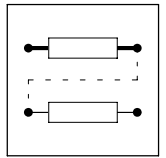

2.4 Function blocks

2.4.1 List of function blocks

Function block	Description	CPU time [μs]	used in basic configuration C0005								
			1000	2000	3000	4000	5000	6000	7000	8000	9000
ABS1	Absolute-value generator	4		•	•						
ADD1	Addition block 1	8		•	•				•		•
ADD2	Addition block 2										
AIF-IN	Fieldbus	-	•	•	•	•	•	•	•	•	•
AIF-OUT	Fieldbus	56	•	•	•	•	•	•	•	•	•
AIN1	Analog input X6/1, X6/2	11	•	•	•	•	•	•	•	•	•
AIN2	Analog input X6/3, X6/4	29	•	•	•	•	•	•	•	•	•
AND1	Logic AND, block1	6			•						
AND2	Logic AND, block2										
AND3	Logic AND, block3										
AND4	Logic AND, block4										
AND5	Logic AND, block5										
ANEG1	Analog inverter 1	4	•	•	•	•	•	•	•	•	•
ANEG2	Analog inverter 2					•		•	•	•	•
AOUT1	Analog output X6/62	12	•	•	•	•	•	•	•	•	•
AOUT2	Analog output X6/63			•	•	•	•	•	•	•	•
ARIT1	Arithmetic block 1	11		•	•						•
ARIT2	Arithmetic block 2										
ARIT3	Arithmetic block 3										
ASW1	Analog selector 1	4				•		•	•	•	•
ASW2	Analog selector 2							•	•		
ASW3	Analog selector 3										
BRK1	Holding brake control	15									
CAN-IN	System bus	-	•	•	•	•	•	•	•	•	•
CAN-OUT	System bus	56	•	•	•	•	•	•	•	•	•
CMP1	Comparator 1	15	•	•	•	•	•	•	•	•	•
CMP2	Comparator 2				•						
CMP3	Comparator 3				•						
CMP4	Comparator 4										
CONV1	Analog signal conversion	8		•	•						
CONV2	Analog signal conversion										
CONV3	Converting speed signals into analog signals										•
CONV4	Converting speed signals into analog signals										
CONV5	Converting analog signals into speed signals					•					
CONVPHA1	32-bit conversion	6									
CURVE1	Characteristic function	15									
DB1	Dead band	7									
DCALC1	Diameter calculator	50								•	•
DCTRL	Device control	-	•	•	•	•	•	•	•	•	•
DFIN	Digital frequency input	5						•	•	•	•
DFOUT	Digital frequency output	35	•	•	•	•	•	•	•		
DFRFG1	Digital frequency ramp function generator	40									
DFSET	Digital frequency processing	85					•	•	•		
DIGDEL1	Binary delay element 1	9			•						
DIGDEL2	Binäres delay element 2										

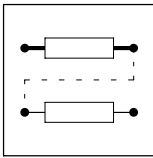

Configuration

Function blocks

Function block	Description	CPU time [μs]	used in basic configuration C0005								
			1000	2000	3000	4000	5000	6000	7000	8000	9000
DIGIN	Input terminal X5/E1...X5/E5	-	•	•	•	•	•	•	•	•	•
DIGOUT	Output terminal X5/A1...X5/A4	-	•	•	•	•	•	•	•	•	•
DT1-1	Differentiator	12									
FCNT1	Free unit counter	11									
FDO	Free digital outputs	-	•	•	•	•	•	•	•	•	•
FEVAN1	Freely assignable input variable	4									
FIXSET1	Fixed setpoints	9		•	•						
FLIP1	D-flipflop 1	6			•						
FLIP2	D-flipflop 2										
FOLL1	Compensator	22									
INT1	Integrator 1	25		•	•						
INT2	Integrator 2										
LIM1	Limiter	6									
MCTRL	Motor control	-	•	•	•	•	•	•	•	•	•
MFAIL	Mains failure control	44									
MLP1	Motor phase failure detection	30									
MONIT	Monitorings	-	•	•	•	•	•	•	•	•	•
MPOT1	Motor potentiometer	20									
NLIM1	Skip frequencies	8	•								
NOT1	Logic NOT, block1	4		•	•						
NOT2	Logic NOT, block2										
NOT3	Logic NOT, block3										
NOT4	Logic NOT, block4										
NOT5	Logic NOT, block5										
NSET	Speed setpoint conditioning	70	•	•	•	•	•				
OR1	Logic OR, block1	6		•	•					•	•
OR2	Logic OR, block2									•	•
OR3	Logic OR, block3										
OR4	Logic OR, block4										
OR5	Logic OR, block5										
OSZ	Oscilloscope function	70									
PCTRL1	Process controller 1	58									
PCTRL2	Process controller 2	44								•	•
PT1-1	First-order delay elements	8								•	
PT1-2											
R/L/Q	QSP / setpoint inversion	8	•	•	•	•	•	•	•	•	•
RFG1	Ramp function generator	16						•	•		
S&H	Sample and hold	4									
SQRT1	Root calculator	18									
SRFG1	S-shaped ramp function generator	15									
STAT	Digital status signals	-	•	•	•	•	•	•	•	•	•
TRANS1	Binary transition evaluation	7		•	•						
TRANS2	Binary transition evaluation										

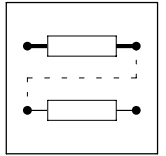

2.4.2 List of free control codes

Free control code	CPU time [μs]	used in basic configuration C0005								
		1000	2000	3000	4000	5000	6000	7000	8000	9000
FCODE16	-	•	•	•	•	•	•	•	•	•
FCODE17		•	•	•	•	•	•	•	•	•
FCODE26/1		•	•	•	•	•	•	•	•	•
FCODE26/2		•	•	•	•	•	•	•	•	•
FCODE27/1		•	•	•	•	•	•	•	•	•
FCODE27/2		•	•	•	•	•	•	•	•	•
FCODE32						•	•	•		
FCODE37										
FCODE108/1		•	•	•	•	•	•	•	•	•
FCODE108/2		•	•	•	•	•	•	•	•	•
FCODE109/1		•	•	•	•	•	•	•	•	•
FCODE109/2		•	•	•	•	•	•	•	•	•
FCODE141				•			•	•	•	•
FCODE175										
FCODE250										
FCODE471										
FCODE472/1				•					•	•
FCODE472/2										
FCODE472/3										
FCODE472/4										
FCODE472/5										
FCODE472/6										
FCODE472/7										
FCODE472/8										
FCODE472/9										
FCODE472/10										
FCODE472/11										
FCODE472/12										
FCODE472/13										
FCODE472/14										
FCODE472/15										
FCODE472/16										
FCODE472/17										
FCODE472/18										
FCODE472/19										
FCODE472/20										
FCODE473/1						•	•	•		
FCODE473/2										
FCODE473/3										
FCODE473/4										
FCODE473/5										
FCODE473/6										
FCODE473/7										
FCODE473/8										
FCODE473/9										
FCODE473/10										
FCODE474/1				•			•			
FCODE474/2							•			
FCODE475/1										
FCODE475/2										

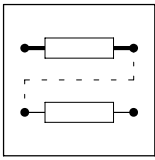

Configuration

Function blocks

2.4.3 Absolute value generation (ABS)

This FB changes bipolar signals to unipolar signals.

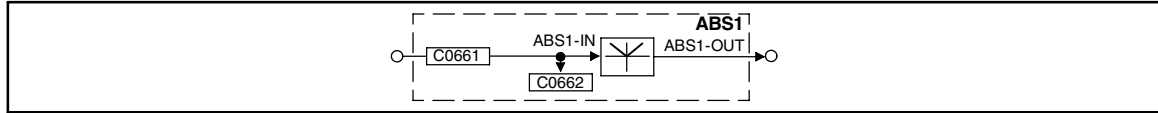

Fig. 2-20

Absolute value generator (ABS1)

Name	Signal			Source			Note
	Type	DIS	DIS format	CFG	List	Lenze	
ABS1-IN1	a	C0662	dec [%]	C0661	1	1000	-
ABS1-OUT	a	-	-	-	-	-	-

Function

The absolute value of the input signal is generated.

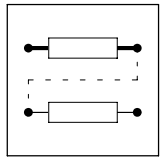

2.4.4 Addition (ADD)

These FBs add or subtract analog signals, depending on the input that is used.

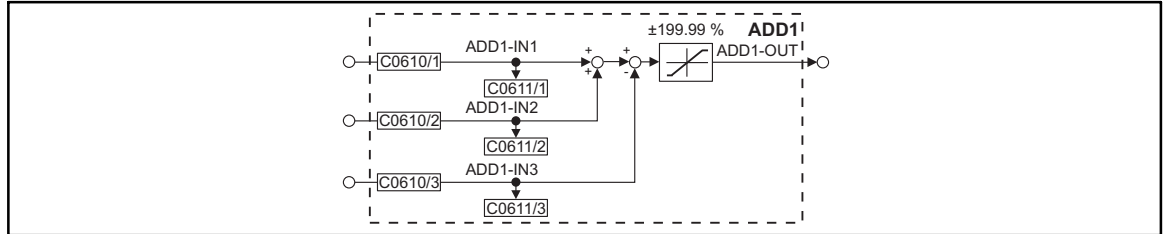

Fig. 2-21 Addition (ADD1)

Name	Signal			Source			Note
	Type	DIS	DIS format	CFG	List	Lenze	
ADD1-IN1	a	C0611/1	dec [%]	C0610/1	1	1000	Addition input
ADD1-IN2	a	C0611/2	dec [%]	C0610/2	1	1000	Addition input
ADD1-IN3	a	C0611/3	dec [%]	C0610/3	1	1000	Subtraction input
ADD1-OUT	a	-	-	-	-	-	Limited to ±199.99 %

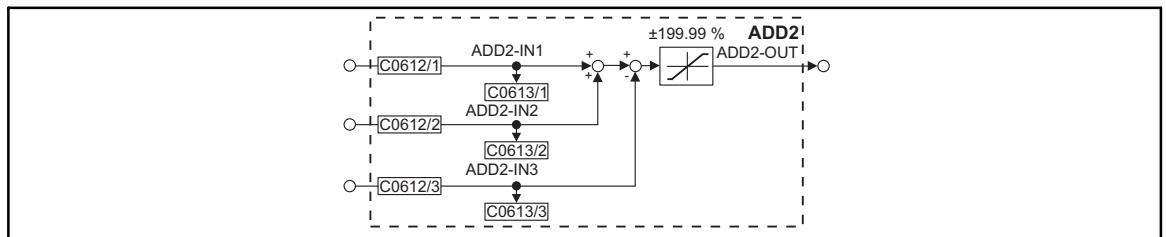
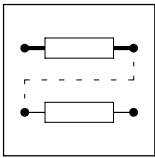

Fig. 2-22 Addition (ADD2)

Name	Signal			Source			Note
	Type	DIS	DIS format	CFG	List	Lenze	
ADD2-IN1	a	C0612/1	dec [%]	C0613/1	1	1000	Addition input
ADD2-IN2	a	C0612/2	dec [%]	C0613/2	1	1000	Addition input
ADD2-IN3	a	C0612/3	dec [%]	C0613/3	1	1000	Subtraction input
ADD2-OUT	a	-	-	-	-	-	Limited to ±199.99 %

Functional sequence

1. The value at ADDx-IN1 is added to the value of ADDx-IN2.
2. The value of ADDx-IN3 is subtracted from the calculated result.
3. Then the result of the subtraction is limited to ±199.99 %.



Configuration

Function blocks

2.4.5 Automation interface (AIF-IN)

This FB is used as an interface for input signals from the connected field bus module (e.g. INTERBUS, PROFIBUS-DP) for setpoints and actual values as binary, analog or phase information.



Tip!

Please observe the corresponding Operating Instructions of the connected field bus module.

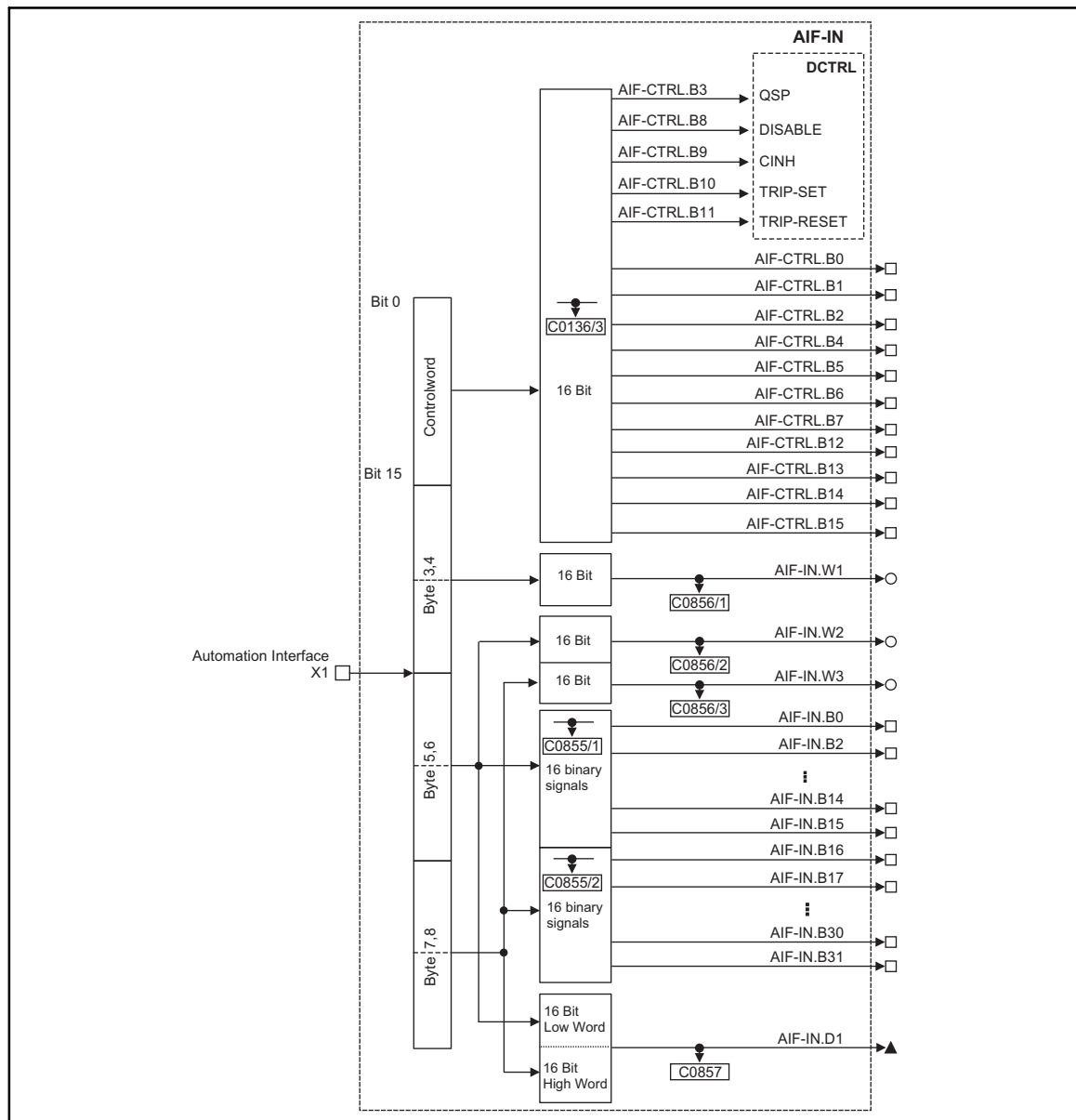
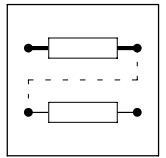
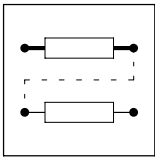

Fig. 2-23 Automation interface (AIF-IN)



Name	Signal			Source			Note
	Type	DIS	DIS format	CFG	List	Lenze	
AIF-CTRL.B0	d	C0136/3	hex	-	-	-	-
AIF-CTRL.B1	d	C0136/3	hex	-	-	-	-
AIF-CTRL.B2	d	C0136/3	hex	-	-	-	-
AIF-CTRL.B4	d	C0136/3	hex	-	-	-	-
AIF-CTRL.B5	d	C0136/3	hex	-	-	-	-
AIF-CTRL.B6	d	C0136/3	hex	-	-	-	-
AIF-CTRL.B7	d	C0136/3	hex	-	-	-	-
AIF-CTRL.B12	d	C0136/3	hex	-	-	-	-
AIF-CTRL.B13	d	C0136/3	hex	-	-	-	-
AIF-CTRL.B14	d	C0136/3	hex	-	-	-	-
AIF-CTRL.B15	d	C0136/3	hex	-	-	-	-
AIF-IN.W1	a	C0856/1	dec [%]	-	-	-	+16384 = +100 %
AIF-IN.W2	a	C0856/2	dec [%]	-	-	-	+16384 = +100 %
AIF-IN.W3	a	C0856/3	dec [%]	-	-	-	+16384 = +100 %
AIF-IN.D1	ph	C0857	dec [inc]	-	-	-	65536 = 1 revolution
AIF-IN.B0	d	C0855/1	hex	-	-	-	-
AIF-IN.B1	d	C0855/1	hex	-	-	-	-
AIF-IN.B2	d	C0855/1	hex	-	-	-	-
AIF-IN.B3	d	C0855/1	hex	-	-	-	-
AIF-IN.B4	d	C0855/1	hex	-	-	-	-
AIF-IN.B5	d	C0855/1	hex	-	-	-	-
AIF-IN.B6	d	C0855/1	hex	-	-	-	-
AIF-IN.B7	d	C0855/1	hex	-	-	-	-
AIF-IN.B8	d	C0855/1	hex	-	-	-	-
AIF-IN.B9	d	C0855/1	hex	-	-	-	-
AIF-IN.B10	d	C0855/1	hex	-	-	-	-
AIF-IN.B11	d	C0855/1	hex	-	-	-	-
AIF-IN.B12	d	C0855/1	hex	-	-	-	-
AIF-IN.B13	d	C0855/1	hex	-	-	-	-
AIF-IN.B14	d	C0855/1	hex	-	-	-	-
AIF-IN.B15	d	C0855/1	hex	-	-	-	-
AIF-IN.B16	d	C0855/2	hex	-	-	-	-
AIF-IN.B17	d	C0855/2	hex	-	-	-	-
AIF-IN.B18	d	C0855/2	hex	-	-	-	-
AIF-IN.B19	d	C0855/2	hex	-	-	-	-
AIF-IN.B20	d	C0855/2	hex	-	-	-	-
AIF-IN.B21	d	C0855/2	hex	-	-	-	-
AIF-IN.B22	d	C0855/2	hex	-	-	-	-
AIF-IN.B23	d	C0855/2	hex	-	-	-	-
AIF-IN.B24	d	C0855/2	hex	-	-	-	-
AIF-IN.B25	d	C0855/2	hex	-	-	-	-
AIF-IN.B26	d	C0855/2	hex	-	-	-	-
AIF-IN.B27	d	C0855/2	hex	-	-	-	-
AIF-IN.B28	d	C0855/2	hex	-	-	-	-
AIF-IN.B29	d	C0855/2	hex	-	-	-	-
AIF-IN.B30	d	C0855/2	hex	-	-	-	-
AIF-IN.B31	d	C0855/2	hex	-	-	-	-



Configuration

Function blocks

Function

The input signals of the 8 byte user data of the AIF object are converted into corresponding signal types. The signals can be used via further function blocks.

Control word (Byte 1, 2)

Byte 1, 2 form the control word for the controller. The bits 3, 8, 9, 10, and 11 of these bytes are directly transferred to the function block DCTRL where they are linked to other signals. The other 11 bits can be used to control further function blocks.

Byte 3, 4

Byte 3, 4 are the signal to AIF-IN.W1.

Byte 5, 6, and byte 7, 8

The meaning of these user data results from the different signal types which you can select. Depending on the requirement, these data can be evaluated as up to 2 analog signals, 32 digital signals or one phase signal. Mixed forms are also possible.

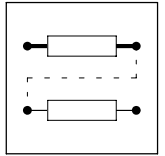

2.4.6 Automation interface (AIF-OUT)

This FB is used as an interface for output signals to the connected field bus module (e.g. INTERBUS, PROFIBUS-DP) for setpoints and actual values as binary, analog or phase information.



Tip!

Please observe the corresponding Operating Instructions of the connected field bus module.

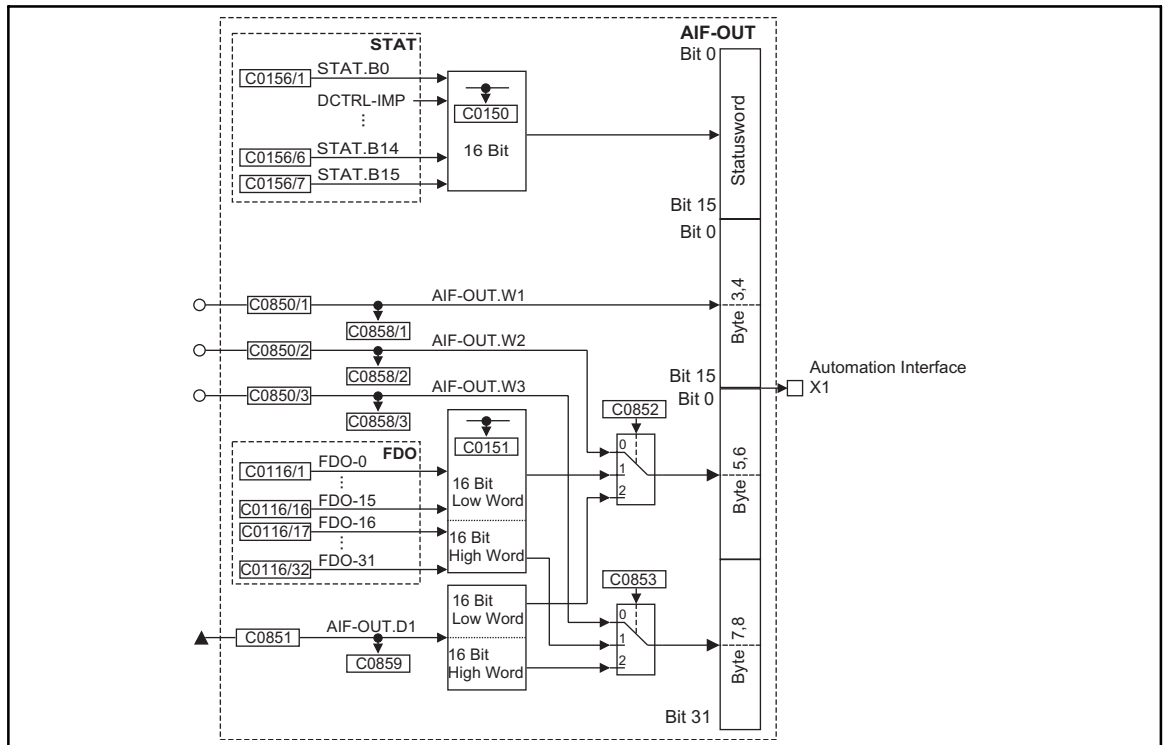
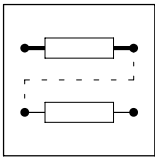

Fig. 2-24 Automation interface (AIF-OUT)

Name	Signal			Source			Note
	Type	DIS	DIS format	CFG	List	Lenze	
AIF-OUT.W1	a	C0858/1	dec [%]	C0850/1	1	1000	+100 % = +16384
AIF-OUT.W2	a	C0858/2	dec [%]	C0850/2	1	1000	+100 % = +16384
AIF-OUT.W3	a	C0858/3	dec [%]	C0850/3	1	1000	+100 % = +16384
AIF-OUT.D1	ph	C0859	abs [inc]	C0851	4	1000	1 revolution = 65536



Configuration

Function blocks

Function

The input signals of this FB are copied to the 8 byte user data of the AIF object and laid on the connected field bus module. The meaning of the user data can be determined very easily with C0852 and C0853 and the corresponding configuration codes.

Status word (Byte 1, 2)

Here, the status word of the function block STAT is mapped. Some of the bits are freely assignable.
(2-160)

Byte 3, 4

The analog signal at AIF-OUT.W1 is output.

Byte 5, 6

- C0852 = 0
– The analog signal to AIF-OUT.W2 is output.
- C0852 = 1
– Bits 0 ... 15 of FDO are output.
- C0852 = 2
– The LOW WORD from AIF-OUT.D1 is output.

Byte 7, 8

- C0853 = 0
– The analog signal at AIF-OUT.W3 is output.
- C0853 = 1
– Bits 16 ... 31 of FDO are output.
- C0853 = 2
– The HIGH WORD of AIF-OUT.D1 is output.

Example

You want to output 16 digital signals of FDO and the LOW WORD of AIF-OUT.D1:

- The LOW-WORD of AIF-OUT.D1 can only be output on byte 5 and 6.
– For this, C0852 is set to 2. The phase signal at C0851 is output on byte 5 and 6.
- For the digital signals, only the bits 16 ... 31 (byte 7 and 8) are available:
– For this, C0853 is set to 1. Bit 16 ... 31 (FDO) are output on byte 7 and 8.

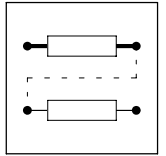

2.4.7 Analog inputs via terminal X6/1,2 and X6/3,4 (AIN)

These FBs are the interface for analog signals as setpoint input, actual value input and parameter control.

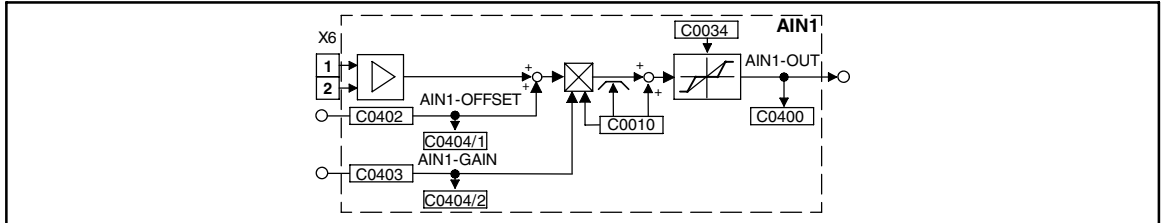

Fig. 2-25 Analog input via terminal X6/1,2 (AIN1)

Name	Signal			Source			Note
	Type	DIS	DIS format	CFG	List	Lenze	
AIN1-OFFSET	a	C0404/1	dec [%]	C0402	1	19502	-
AIN1-GAIN	a	C0404/2	dec [%]	C0403	1	19504	-
AIN1-OUT	a	C0400	dec [%]	-	-	-	-

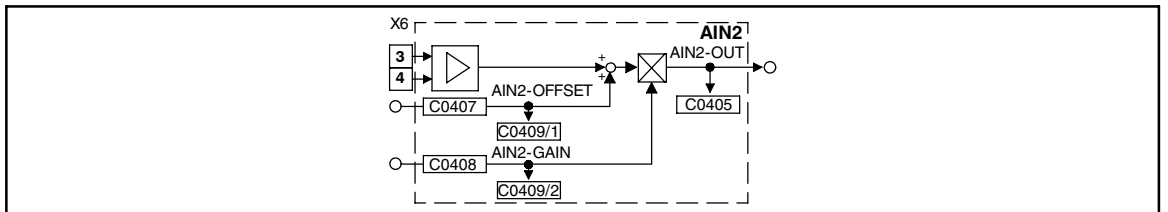
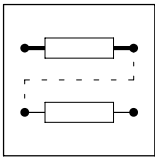

Fig. 2-26 Analog input via terminal X6/3, 4 (AIN2)

Name	Signal			Source			Note
	Type	DIS	DIS format	CFG	List	Lenze	
AIN2-OFFSET	a	C0409/1	dec [%]	C0407	1	19503	-
AIN2-GAIN	a	C0409/2	dec [%]	C0408	1	19505	-
AIN2-OUT	a	C0406	dec [%]	-	-	-	-



Configuration

Function blocks

Function

- Offset
 - The value at AINx-OFFSET is added to the value at AINx-IN.
 - The result of the addition is limited to $\pm 200\%$.
- Gain
 - The limited value (after offset) is multiplied with the value at AINx-GAIN.
 - The gain is then limited to $\pm 200\%$.
- The signal is output at AINx-OUT.

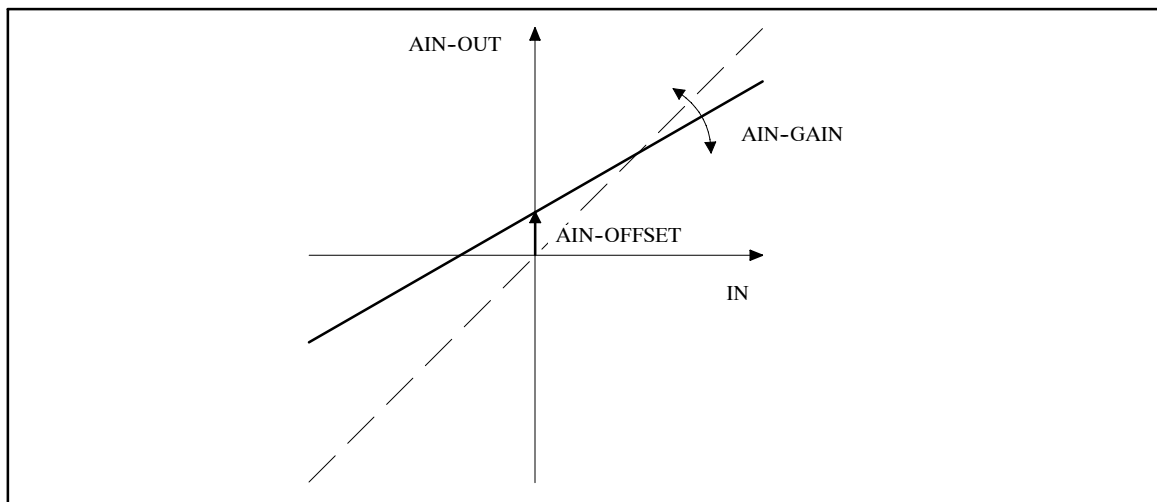

Fig. 2-27

Offset and gain of the analog input

Special feature of AIN1

- A minimum speed can be set under C0010. The signal gain is reduced such that the signal at AIN1-OUT = 100 % with a setpoint of 10 V at X6/1 and X6/2.
 - Setting range: 0 ... 36000 rpm
 - Setting range: 0 rpm (function inactive)
 - Input limits: C0010 < C0011
 - AIN1-OFFSET and AIN1-GAIN are independent of C0010.
- A dead band element can be integrated into the output signal at AIN1 via C0034. You can achieve the function 4 ... 20 mA as a current master value together with the jumper setting X2 (controller front).
- The signal at X6/1 and X6/2 is read cyclically (1 ms).

Special feature of AIN2

- The signal at X6/3 and X6/4 is read cyclically (250 μ s).

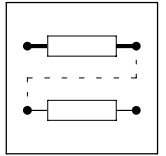

2.4.8 Logic AND (AND)

These FBs carry out logic AND operations of digital signals. You can use these FBs for the control of functions or the generation of status information.

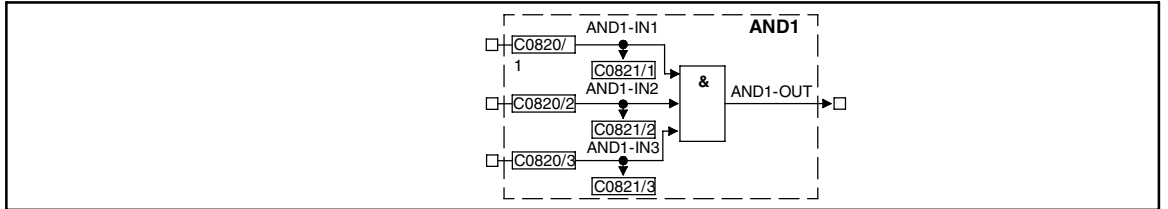

Fig. 2-28 Logic AND (AND1)

Name	Signal			Source			Note
	Type	DIS	DIS format	CFG	List	Lenze	
AND1-IN1	d	C0821/1	bin	C0820/1	2	1000	-
AND1-IN2	d	C0821/2	bin	C0820/2	2	1000	-
AND1-IN3	d	C0821/3	bin	C0820/3	2	1000	-
AND1-OUT	d	-	-	-	-	-	-

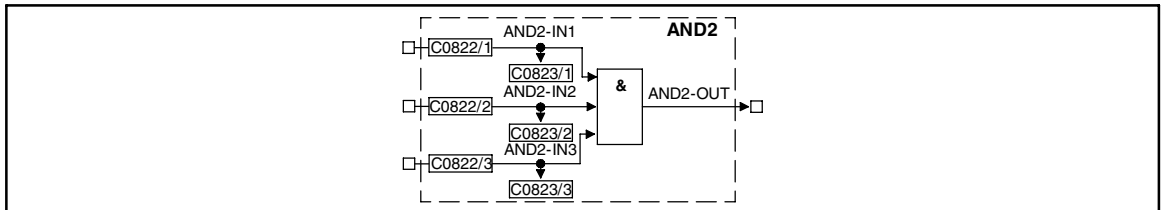
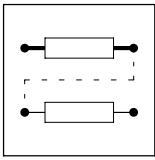

Fig. 2-29 Logic AND (AND2)

Name	Signal			Source			Note
	Type	DIS	DIS format	CFG	List	Lenze	
AND2-IN1	d	C0823/1	bin	C0822/1	2	1000	-
AND2-IN2	d	C0823/2	bin	C0822/2	2	1000	-
AND2-IN3	d	C0823/3	bin	C0822/3	2	1000	-
AND2-OUT	d	-	-	-	-	-	-



Configuration

Function blocks

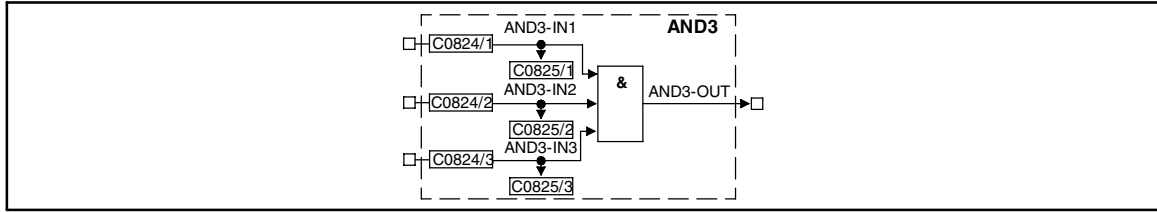

Fig. 2-30

Logic AND (AND3)

Name	Signal			Source			Note
	Type	DIS	DIS format	CFG	List	Lenze	
AND3-IN1	d	C0825/1	bin	C0824/1	2	1000	-
AND3-IN2	d	C0825/2	bin	C0824/2	2	1000	-
AND3-IN3	d	C0825/3	bin	C0824/3	2	1000	-
AND3-OUT	d	-	-	-	-	-	-

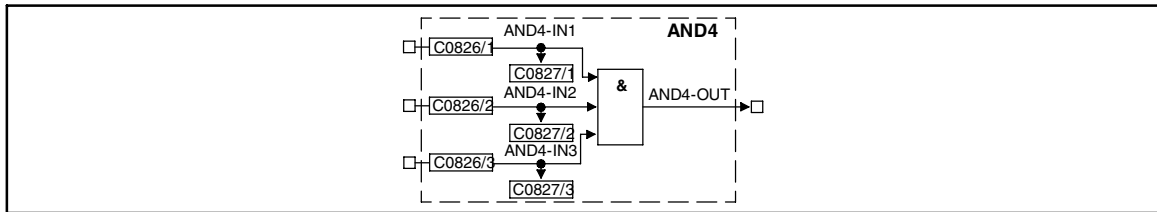

Fig. 2-31

Logic AND (AND4)

Name	Signal			Source			Note
	Type	DIS	DIS format	CFG	List	Lenze	
AND4-IN1	d	C0827/1	bin	C0826/1	2	1000	-
AND4-IN2	d	C0827/2	bin	C0826/2	2	1000	-
AND4-IN3	d	C0827/3	bin	C0826/3	2	1000	-
AND4-OUT	d	-	-	-	-	-	-

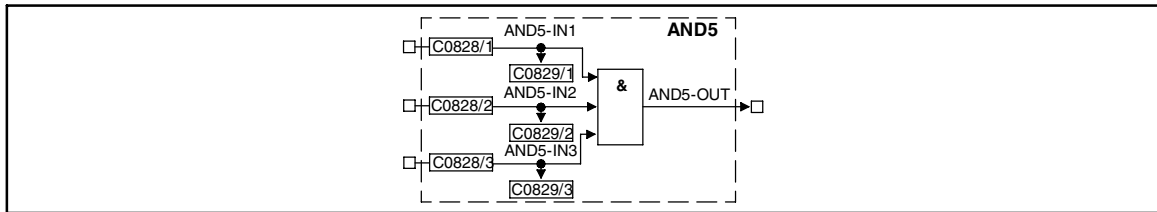
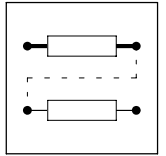

Fig. 2-32

Logic AND (AND5)

Name	Signal			Source			Note
	Type	DIS	DIS format	CFG	List	Lenze	
AND5-IN1	d	C0829/1	bin	C0828/1	2	1000	-
AND5-IN2	d	C0829/2	bin	C0828/2	2	1000	-
AND5-IN3	d	C0829/3	bin	C0828/3	2	1000	-
AND5-OUT	d	-	-	-	-	-	-



Function

ANDx-IN1	ANDx-IN2	ANDx-IN3	ANDx-OUT
0	0	0	0
1	0	0	0
0	1	0	0
1	1	0	0
0	0	1	0
1	0	1	0
0	1	1	0
1	1	1	1

0 = LOW

1 = HIGH

In a contactor control, the function corresponds to a series connection of normally-open contacts.

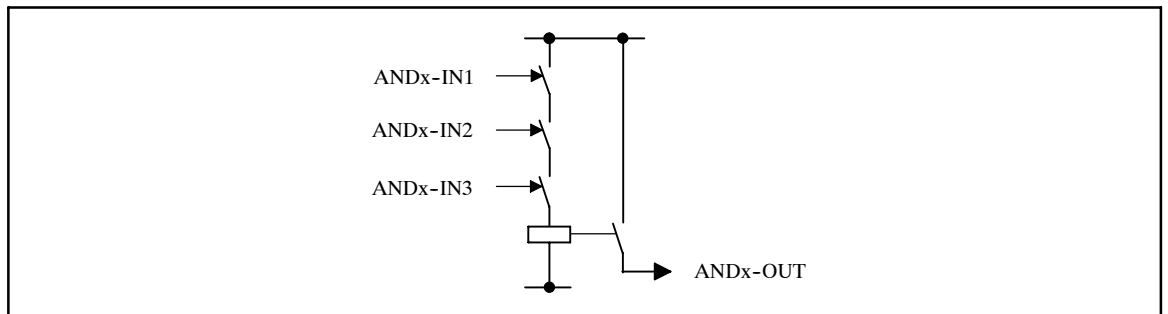

Fig. 2-33

AND function as a series connection of normally-open contacts



Tip!

If only two inputs are required, use the inputs ANDx-IN1 and ANDx-IN2. Assign the input ANDx-IN3 to the signal source FIXED1.

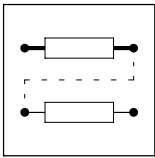

Configuration

Function blocks

2.4.9 Inversion (ANEG)

These FBs invert the sign of an analog signal. The input value is multiplied with -1 and then output.

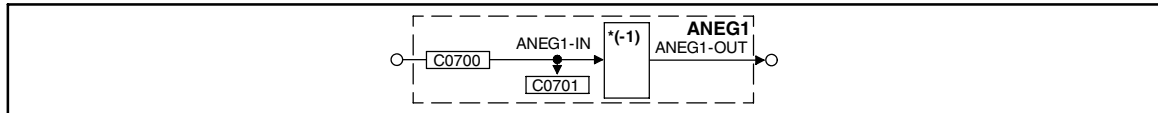

Fig. 2-34 Inverter (ANEG1)

Name	Signal			Source			Note
	Type	DIS	DIS format	CFG	List	Lenze	
ANEG1-IN	a	C0701	dec [%]	C0700	1	19523	-
ANEG1-OUT	a	-	-	-	-	-	-

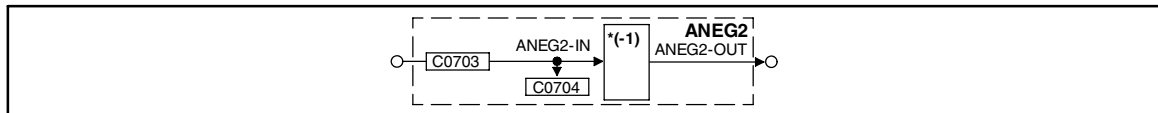
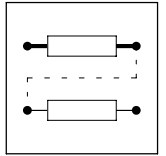

Fig. 2-35 Inverter (ANEG2)

Name	Signal			Source			Note
	Type	DIS	DIS format	CFG	List	Lenze	
ANEG2-IN	a	C0704	dec [%]	C0703	1	1000	-
ANEG2-OUT	a	-	-	-	-	-	-



2.4.10 Analog outputs via terminals X6/62 and X6/63 (AOUT)

These FB are used to output internal analog signals as voltage signals and e.g. display values or set-points for slaves.

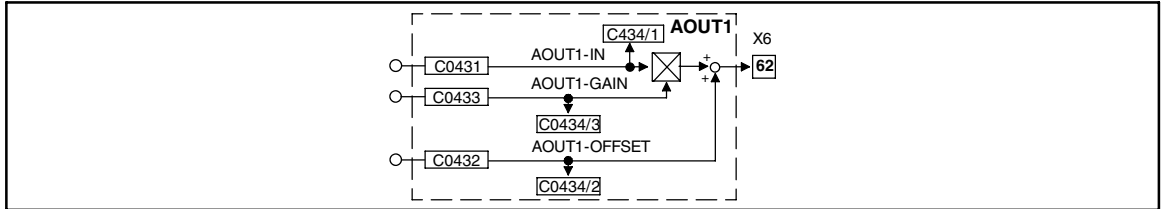

Fig. 2-36 Analog output via terminal X6/62 (AOUT1)

Name	Signal			Source			Note
	Type	DIS	DIS format	CFG	List	Lenze	
AOUT1-IN	a	C0434/1	dec [%]	C0431	1	5001	-
AOUT1-OFFSET	a	C0434/2	dec [%]	C0432	1	19512	-
AOUT1-GAIN	a	C0434/3	dec [%]	C0433	1	19510	-

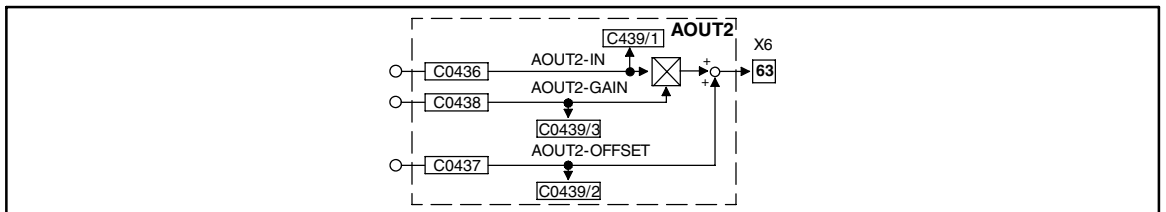
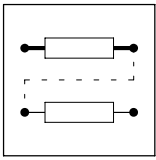

Fig. 2-37 Analog output via terminal X6/63 (AOUT2)

Name	Signal			Source			Note
	Type	DIS	DIS format	CFG	List	Lenze	
AOUT2-IN	a	C0439/1	dec [%]	C0436	1	5002	-
AOUT2-OFFSET	a	C0439/2	dec [%]	C0437	1	19513	-
AOUT2-GAIN	a	C0439/3	dec [%]	C0438	1	19511	-



Configuration

Function blocks

Function

- Gain
 - The value at AOUTx-IN is multiplied with the value at AOUTx-GAIN.
 - Example for the multiplication of analog signals:
 $100 \% \cdot 100 \% = 100 \%$
 - The result of the multiplication is limited to $\pm 200\%$.
- Offset
 - The limited value (after the gain) is added to the value at AOUTx-OFFSET.
 - The result of the addition is limited to $\pm 200\%$.
- The result of the calculation is mapped in such a way that 100% = 10 V. This signal is output at terminal X6/62 or X6/63.

Example:

AOUT1-IN = 50 %

AOUT1-GAIN = 100 %

AOUT1-OFFSET = 10 %

Signal at terminal X6/62:

$((50 \% \cdot 100 \%) = 50 \%) + 10 \% = 60 \%) = 6 \text{ V}$

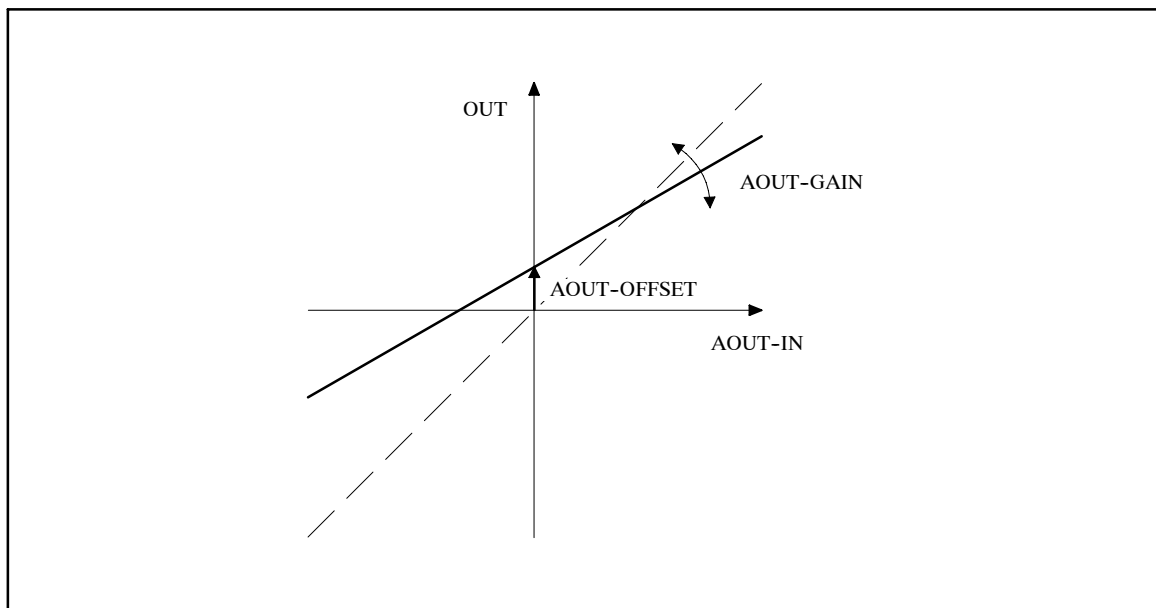
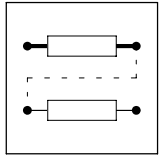

Fig. 2-38

Offset and gain of the analog output



2.4.11 Arithmetic (ARIT)

These FBs combine two analog signals arithmetically.

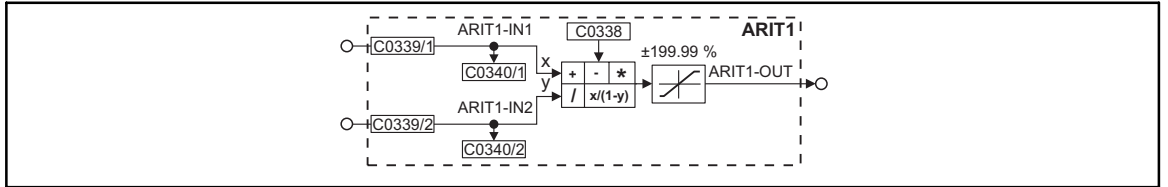

Fig. 2-39

Arithmetic (ARIT1)

Name	Signal			Source			Note
	Type	DIS	DIS format	CFG	List	Lenze	
ARIT1-IN1	a	C0340/1	dec [%]	C0339/1	1	1000	-
ARIT1-IN2	a	C0340/2	dec [%]	C0339/2	1	1000	-
ARIT1-OUT	a	-	-	-	-	-	limited to ±199.99 %

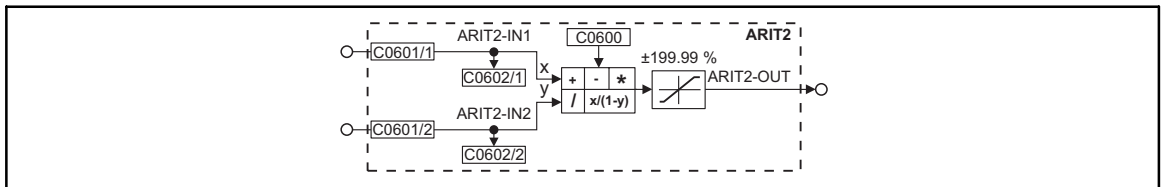

Fig. 2-40

Arithmetic (ARIT2)

Name	Signal			Source			Note
	Type	DIS	DIS format	CFG	List	Lenze	
ARIT2-IN1	a	C0602/1	dec [%]	C0601/1	1	1000	-
ARIT2-IN2	a	C0602/2	dec [%]	C0601/2	1	1000	-
ARIT2-OUT	a	-	-	-	-	-	limited to ±199.99 %

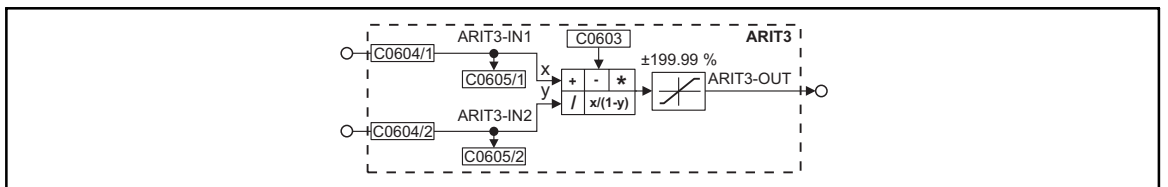
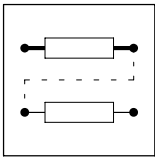

Fig. 2-41

Arithmetic (ARIT3)

Name	Signal			Source			Note
	Type	DIS	DIS format	CFG	List	Lenze	
ARIT3-IN1	a	C0605/1	dec [%]	C0604/1	1	1000	-
ARIT3-IN2	a	C0605/2	dec [%]	C0604/2	1	1000	-
ARIT3-OUT	a	-	-	-	-	-	limited to ±199.99 %



Configuration

Function blocks

Function

Code	Value	Function
C0338 for ARIT1 C0600 for ARIT2 C0603 for ARIT3	0	<ul style="list-style-type: none"> • $ARITx-OUT = ARITx-IN1$ – ARITx-IN2 is not processed
	1	<ul style="list-style-type: none"> • $ARITx-OUT = ARITx-IN1 + ARITx-IN2$ – Example: 100 % = 50 % + 50 %
	2	<ul style="list-style-type: none"> • $ARITx-OUT = ARITx-IN1 - ARITx-IN2$ – Example: 50 % = 100 % - 50 %
	3	<ul style="list-style-type: none"> • $ARITx-OUT = ARITx-IN1 * ARITx-IN2$ – Example: 100 % = 100 % * 100 %
	4	<ul style="list-style-type: none"> • $ARITx-OUT = ARITx-IN1 / ARITx-IN2$ – Example: 1 % = 100% / 100%
	5	<ul style="list-style-type: none"> • $ARITx-OUT = ARITx-IN1 / (100 \% - ARITx-IN2)$ – Example: 200 % = 100 % / (100 % - 50 %)

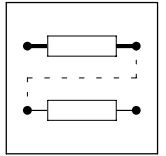

2.4.12 Toggling (ASW)

These FBs toggle between two analog signals, thus enabling two different initial diameters for winding, for instance.

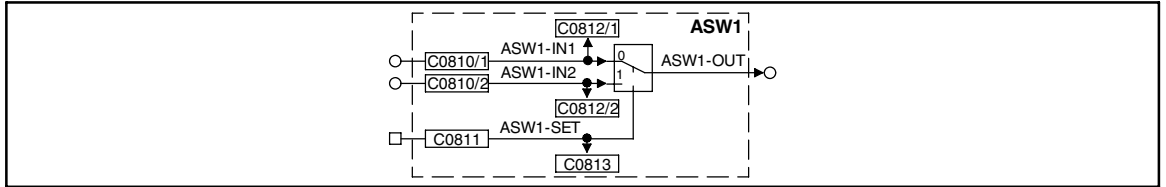

Fig. 2-42

Toggling (ASW1)

Name	Signal			Source			Note
	Type	DIS	DIS format	CFG	List	Lenze	
ASW1-IN1	a	C0812/1	dec [%]	C0810/1	1	55	-
ASW1-IN2	a	C0812/2	dec [%]	C0810/2	1	1000	-
ASW1-SET	d	C0813	bin	C0811	2	1000	-
ASW1-OUT	a	-	-	-	-	-	-

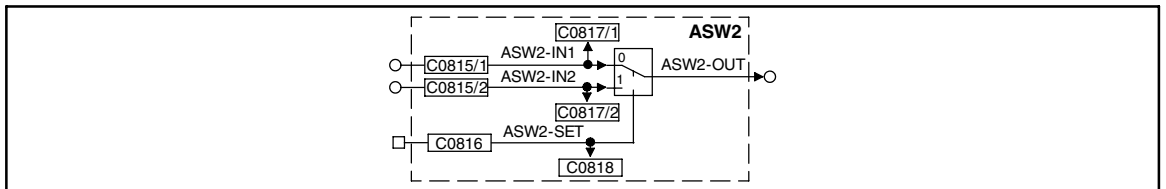
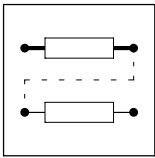

Fig. 2-43

Toggling (ASW2)

Name	Signal			Source			Note
	Type	DIS	DIS format	CFG	List	Lenze	
ASW2-IN2	a	C0817/1	dec [%]	C0815/1	1	1000	-
ASW2-IN1	a	C0817/2	dec [%]	C0815/2	1	1000	-
ASW2-SET	d	C0818	bin	C0816	2	1000	-
ASW2-OUT	a	-	-	-	-	-	-



Configuration

Function blocks

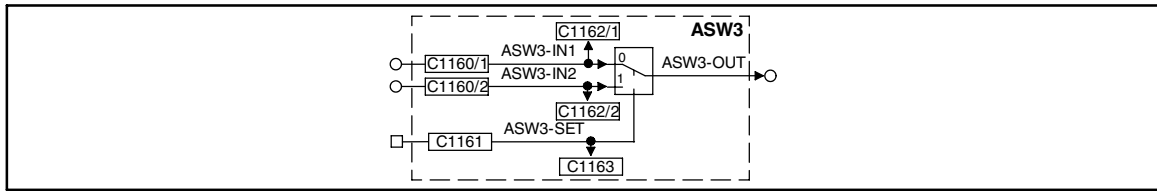

Fig. 2-44

Toggling (ASW3)

Name	Signal			Source			Note
	Type	DIS	DIS format	CFG	List	Lenze	
ASW3-IN2	a	C1162/1	dec [%]	C1160/1	1	1000	-
ASW3-IN1	a	C1162/2	dec [%]	C1160/2	1	1000	-
ASW3-SET	d	C1163	bin	C1161	2	1000	-
ASW3-OUT	a	-	-	-	-	-	-

Function

Control signal	Output signal
ASWx-SET = HIGH	ASWx-OUT = ASWx-IN2
ASWx-SET = LOW	ASWx-OUT = ASWx-IN1

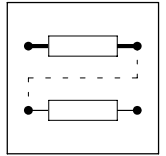

2.4.13 Holding brake (BRK)

This FB triggers a holding brake. You can use it e.g. in configurations for lift and travelling drives and active loads.

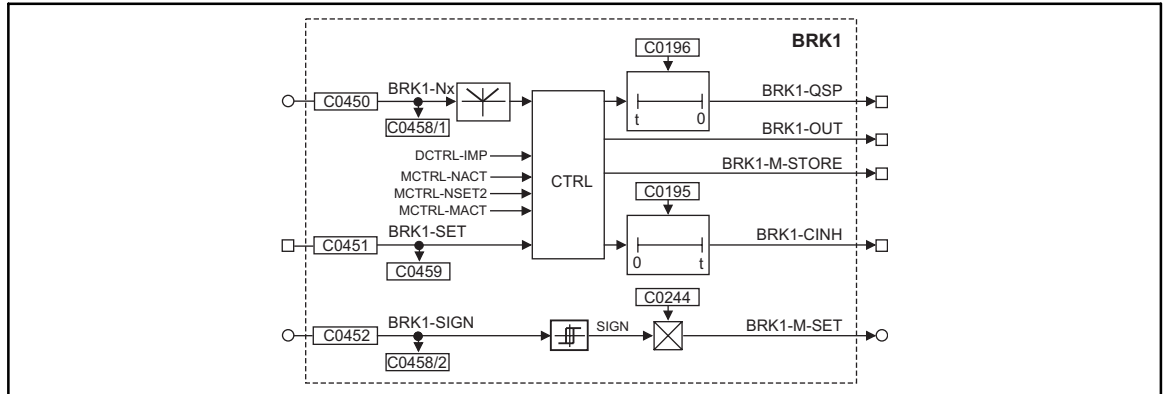

Fig. 2-45 Holding brake (BRK1)

Name	Signal			Source			Note
	Type	DIS	DIS format	CFG	List	Lenze	
BRK1-SET	d	C0459	bin	C0451	2	1000	-
BRK1-NX	a	C0458/1	dec [%]	C0450	1	1000	Speed threshold from which the drive can output the signal "close brake". The signal source for this input can be a control code, a fixed value or any other analog output of a FB.
BRK1-SIGN	a	C0458/2	dec [%]	C0452	1	1000	Direction of the torque with which the drive has to build a torque against the brake. The signal source for this input can be a control code, a fixed value or any other analog output of a FB.
BRK1-M-SET	a	-	dec [%]	C0244	-	0.00	Holding torque of the DC injection brake 100 % = value of C0057
BRK1-T-ACT	a	-	dec	C0195	-	99.9	Brake engaging time
BRK1-T-RELEASE	a	-	dec	C0196	-	0.0	Brake disengaging time



Tip!

The function block processes the absolute values of the signals MCTRL-NACT, MCTRL-MACT, MCTRL-NSET2 and BRK1-Nx.

Range of functions

- Close brake
- Open brake (release)
- Set controller inhibit

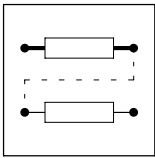

Configuration

Function blocks

2.4.13.1 Close brake

Function procedure

1. The function is activated using BRK1-SET = HIGH.
 - At the same time, BRK1-QSP is set to HIGH. You can use this signal to decelerate the drive to zero speed via a deceleration ramp.
2. If the setpoint speed exceeds the value at BRK1-Nx, BRK1-OUT = HIGH.
 - Invert the signal at the digital output if you need a protection against wire breakage (e. g. via C0118).
3. A time element is triggered when BRK1-OUT = HIGH. After the time set under C0195 has elapsed, BRK1-CINH is set to HIGH.
 - This signal is used to set controller inhibit (inside the controller). In general, the brake close time is set here. This is necessary because the brake does not engage immediately when BRK1-OUT = HIGH and the drive must therefore provide a holding torque for the time set.

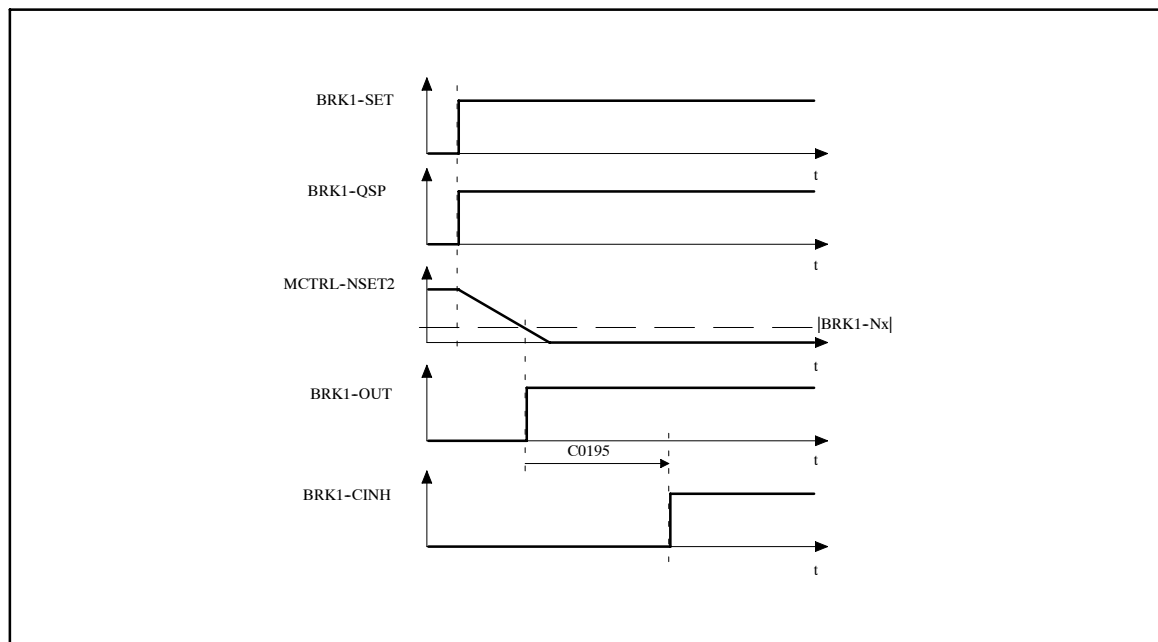
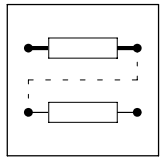

Fig. 2-46 Signal sequence when the brake is closed



2.4.13.2 Open the brake

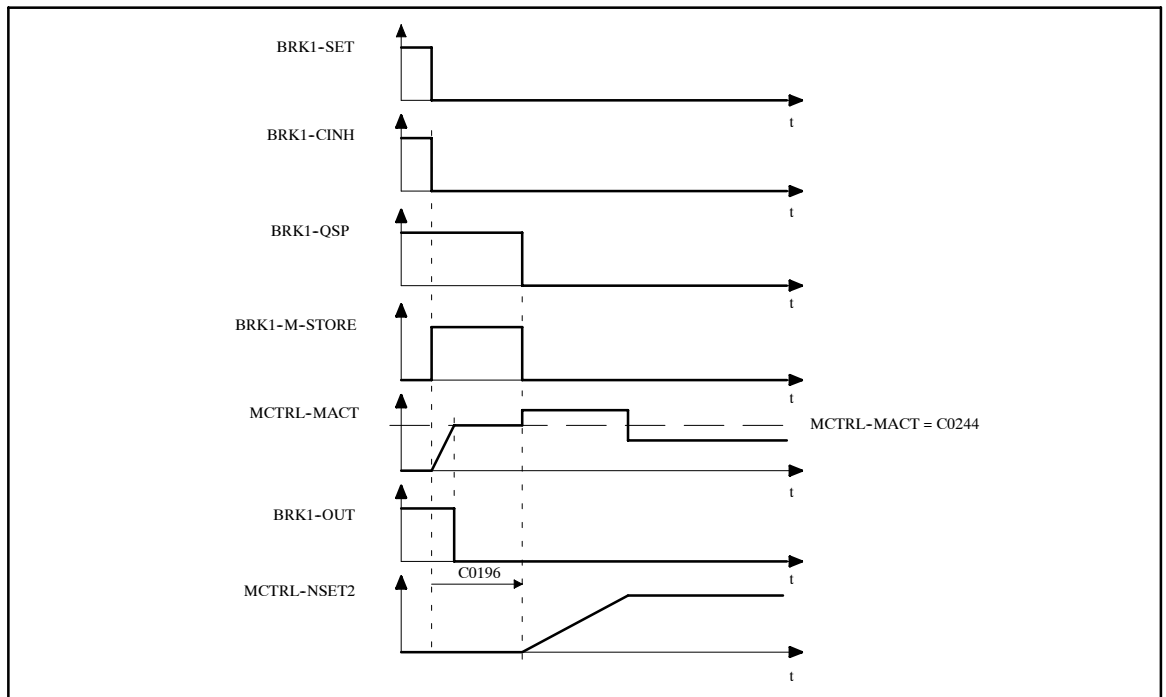

Fig. 2-47 Signal sequence when the brake is opened (released)

Function procedure

1. With BRK-SET = LOW, BRK-CINH is immediately set LOW. At the same time, BRK-M-STORE is set HIGH.
 - You can use this signal to create a defined torque in the drive, before the brake opens. In hoists, for instance, a "lowering" during the load transfer is thus avoided. The signal is reset only after the time set under C0196 has elapsed.
2. Once the torque has reached the value (holding torque) set under C0244, BRK-OUT = LOW.
3. When the input is reset, a time element is triggered. After the time set under C0196 has elapsed, BRK-QSP = LOW.
 - This signal is used e.g. to enable the setpoint integrator after the brake disengaging time has elapsed.



Tip!

- When the brake is disengaged before the brake disengaging time (C0196) has elapsed and an actual speed is detected which is higher than the value at BRK-Nx, BRK-QSP = LOW and BRK-M-STORE = LOW. The drive can immediately operated speed-controlled.
- For an optimum starting behaviour, the time under C0196 should not be much longer than the actual brake disengaging time.

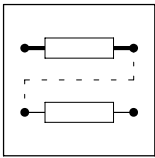

Configuration

Function blocks

2.4.13.3 Set pulse inhibit

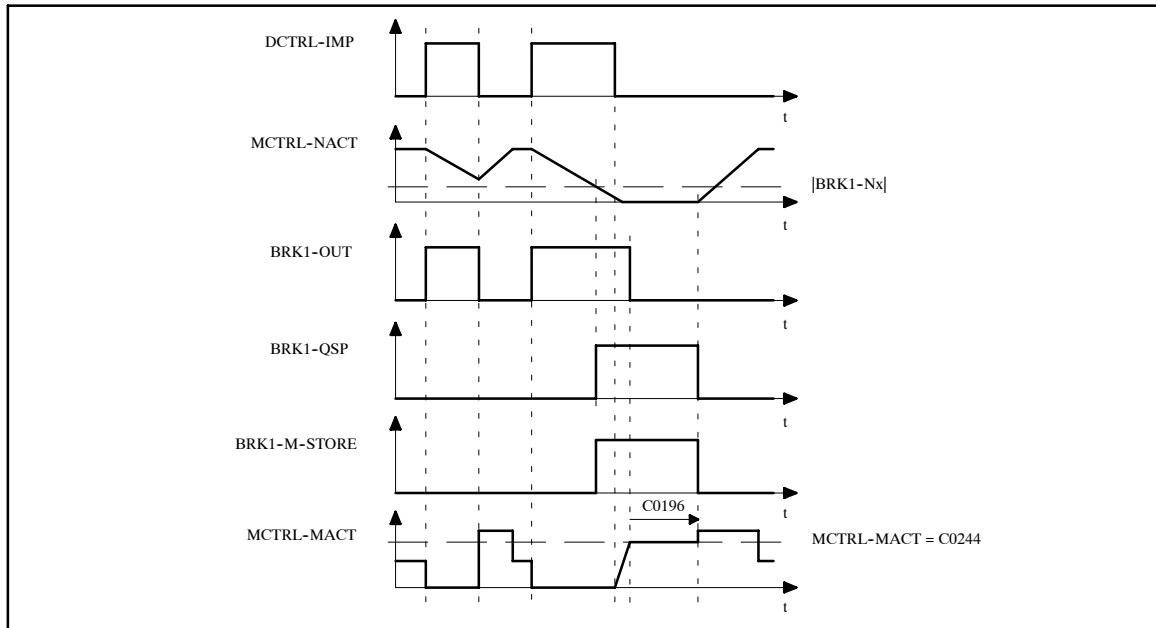

Fig. 2-48 Brake control with IMP (possible only when using an incremental encoder).

Function procedure

1. When pulse inhibit (IMP) by controller inhibit or a fault (LU, OU, ...), BRK-OUT changes immediately to HIGH.
 - The drive is then braked by its mechanical brake.
2. When pulse inhibit is reset (DCTRL-CINH = LOW) before the actual speed has fallen below the threshold BRK-Nx, BRK-OUT changes immediately to LOW (possible only with incremental encoder).
 - The drive synchronizes itself to the momentary speed and follows its setpoint.
 - The drive starts once the threshold was undershot. (2-67)

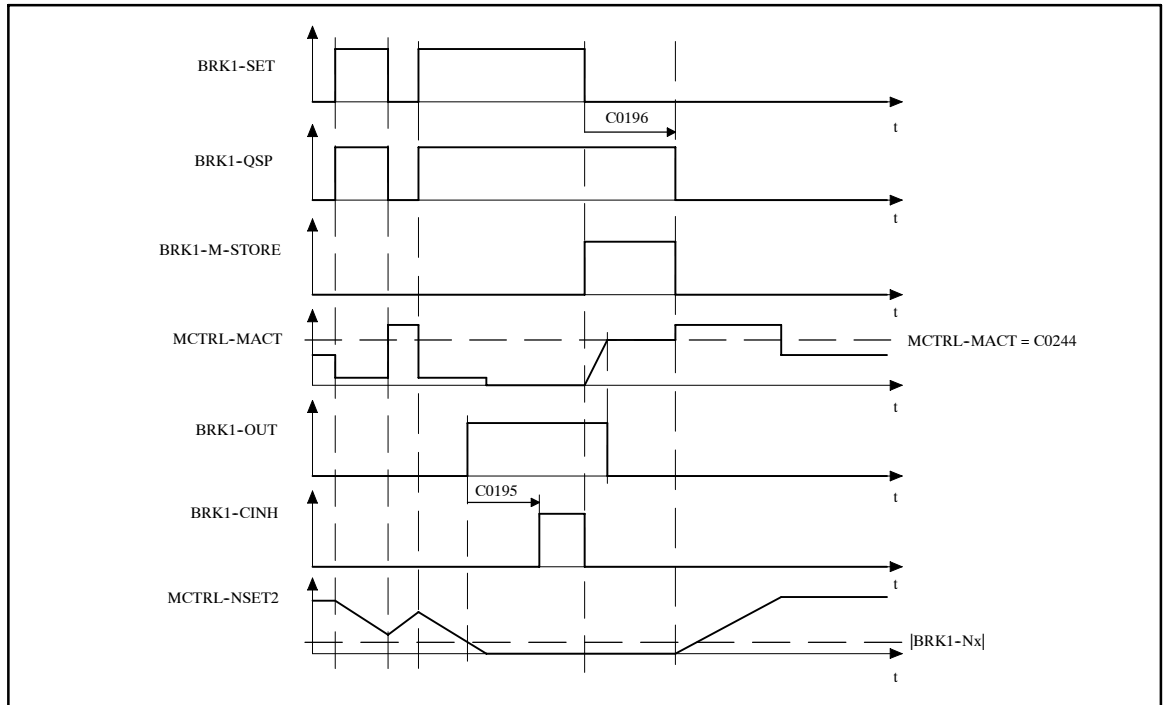
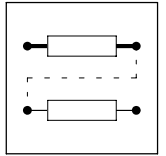
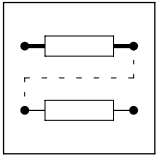

Fig. 2-49 Stopping and starting switching cycle



Configuration

Function blocks

2.4.14 System bus (CAN-IN)

A detailed description of the system bus (CAN) can be found in the "Communication Manual CAN".

2.4.15 System bus (CAN-OUT)

A detailed description of the system bus (CAN) can be found in the "Communication Manual CAN".

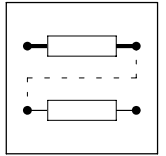

2.4.16 Comparison (CMP)

These FBs compare two analog signals. Comparators can be used as threshold switches. Different comparing functions are available.

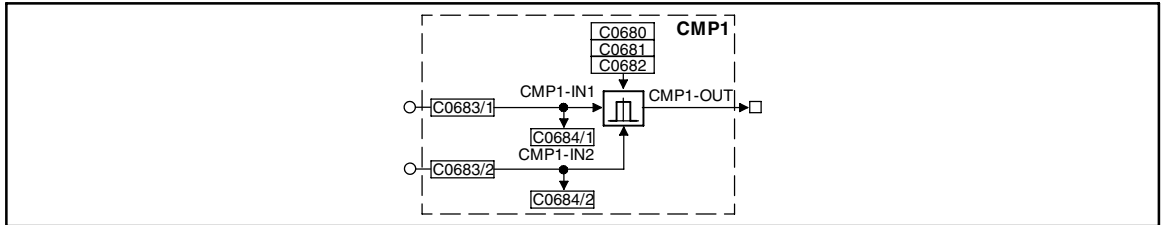

Fig. 2-50 Comparison (CMP1)

Name	Signal			Source			Note
	Type	DIS	DIS format	CFG	List	Lenze	
CMP1-IN1	a	C0684/1	dec [%]	C0683/1	1	5001	-
CMP1-IN2	a	C0684/2	dec [%]	C0683/2	1	19500	-
CMP1-OUT	d	-	-	-	-	-	-

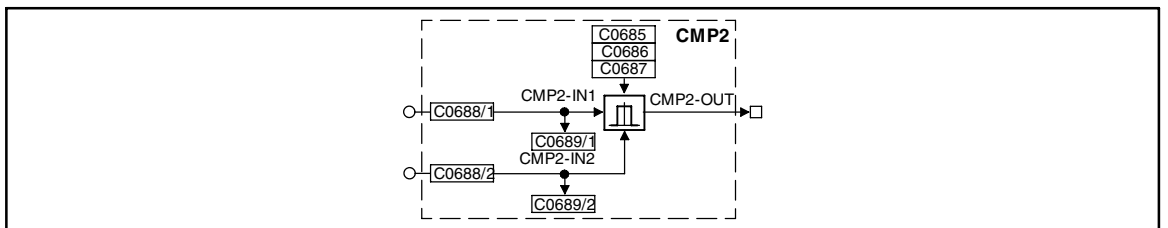

Fig. 2-51 Comparison (CMP2)

Name	Signal			Source			Note
	Type	DIS	DIS format	CFG	List	Lenze	
CMP2-IN1	a	C0689/1	dec [%]	C0688/1	1	1000	-
CMP2-IN2	a	C0689/2	dec [%]	C0688/2	1	1000	-
CMP2-OUT	d	-	-	-	-	-	-

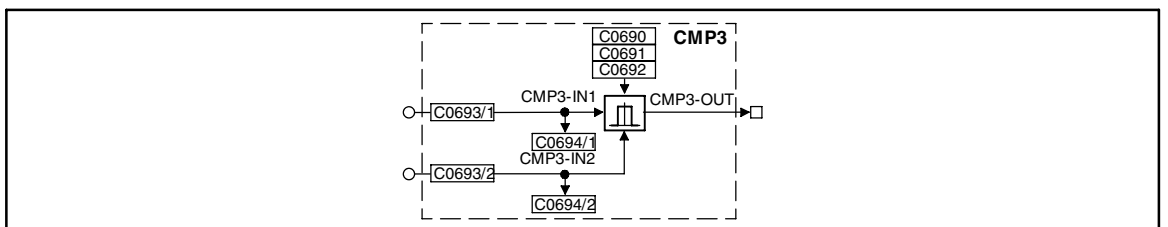
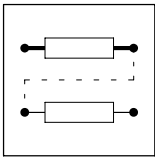

Fig. 2-52 Comparison (CMP3)

Name	Signal			Source			Note
	Type	DIS	DIS format	CFG	List	Lenze	
CMP3-IN1	a	C0694/1	dec [%]	C0693/1	1	1000	-
CMP3-IN2	a	C0694/2	dec [%]	C0693/2	1	1000	-
CMP3-OUT	d	-	-	-	-	-	-



Configuration

Function blocks

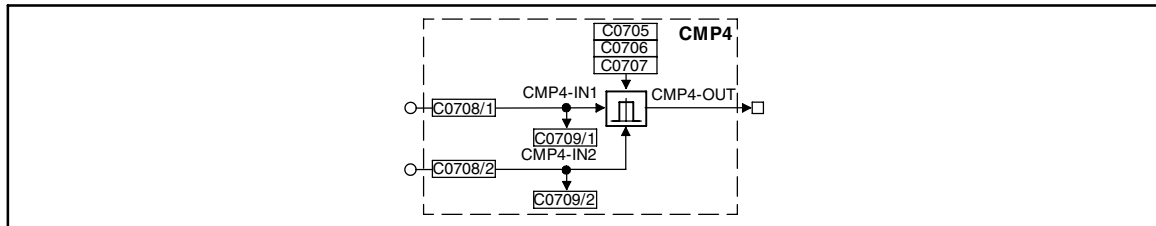

Fig. 2-53

Comparison (CMP4)

Name	Signal			Source			Note
	Type	DIS	DIS format	CFG	List	Lenze	
CMP4-IN1	a	C0709/1	dec [%]	C0708/1	1	1000	-
CMP4-IN2	a	C0709/2	dec [%]	C0708/2	1	1000	-
CMP4-OUT	a	-	-	-	-	-	-

Range of functions

	Code			
	CMP1	CMP2	CMP3	CMP4
Comparing function	C0680	C0685	C0690	C0705
Hysteresis	C0681	C0686	C0691	C0706
Window	C0682	C0687	C0693	C0707

The description of CMP1 serves as an example. It is also valid for CMP2 ... CMP4.

The following comparing functions are available:

- $CMP1-IN1 = CMP1-IN2$
- $CMP1-IN1 > CMP1-IN2$
- $CMP1-IN1 < CMP1-IN2$
- $|CMP1-IN1| = |CMP1-IN2|$
- $|CMP1-IN1| > |CMP1-IN2|$
- $|CMP1-IN1| < |CMP1-IN2|$

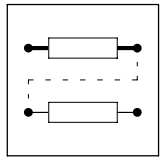

2.4.16.1 Function 1: CMP1-IN1 = CMP1-IN2

- Selection: C0680 = 1
- This function compares two signals. For instance, you can compare the actual speed and the setpoint speed ($n_{act.} = n_{set.}$).
- The exact function can be obtained from the line diagram.

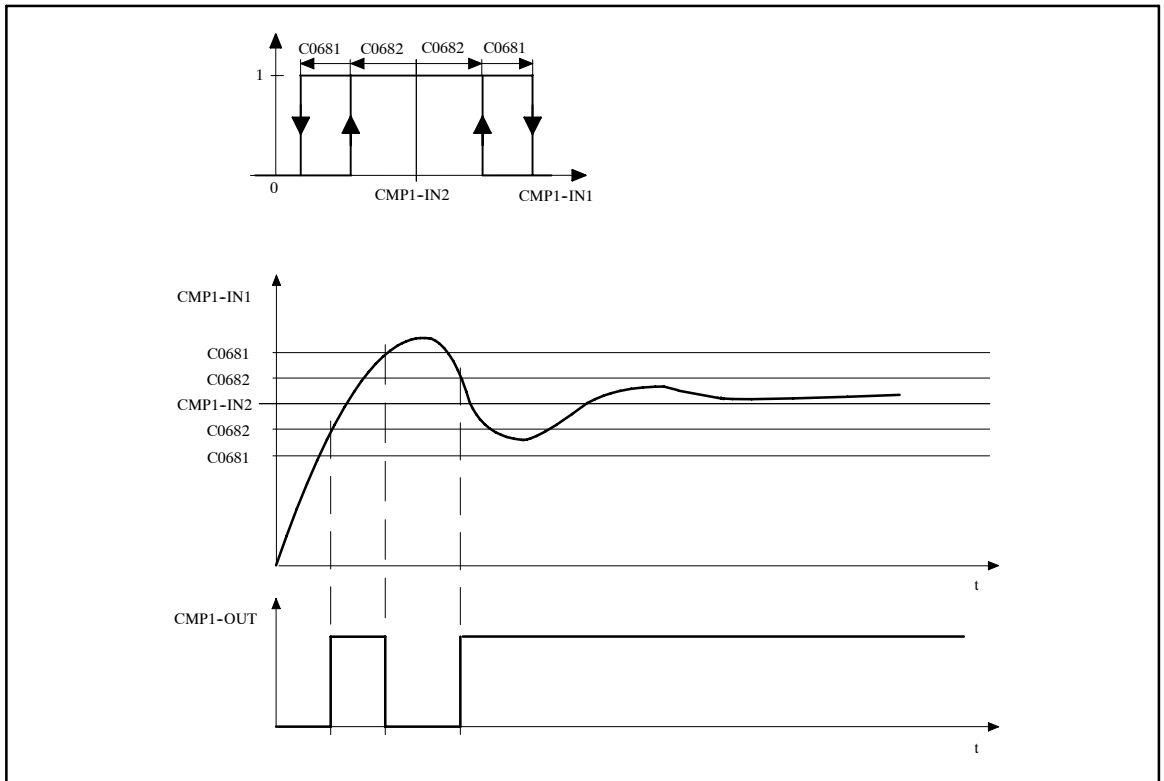
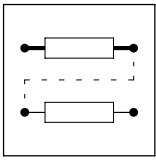

Fig. 2-54 Equality of signals (CMP1-IN1 = CMP1-IN2)

Function procedure

1. Under C0682, set the window where the equality is to be effective.
2. Under C0681 you set a hysteresis if the input signals are not stable and therefore the output oscillates.



Configuration

Function blocks

2.4.16.2 Function 2: $CMP1-IN1 > CMP1-IN2$

- Selection: $C0680 = 2$
- This function is used to find out whether the actual speed is higher than a limit value ($n_{act.} > n_x$) for one direction of rotation.

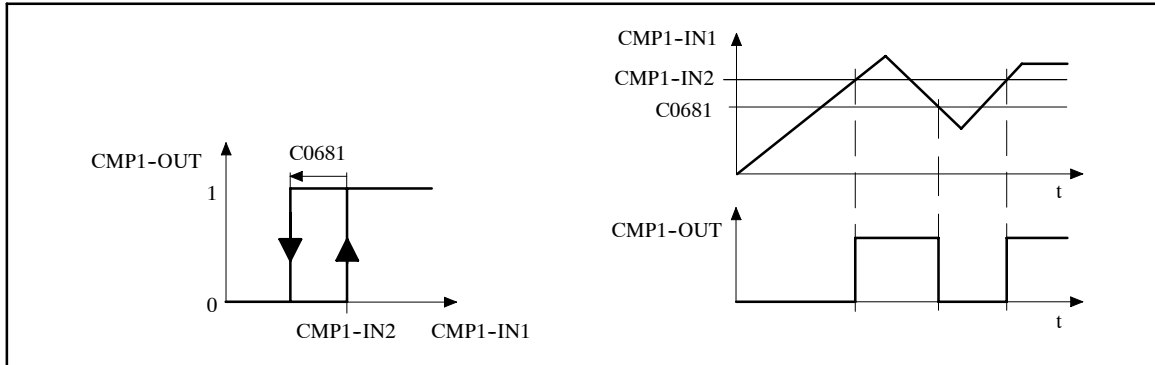

Fig. 2-55 Exceeding signal values ($CMP1-IN1 > CMP1-IN2$)

Function procedure

1. If the value at $CMP1-IN1$ exceeds the value at $CMP1-IN2$, $CMP1-OUT$ changes from LOW to HIGH.
2. If the value at $CMP1-IN1$ undershoots the value at $CMP1-IN2$ minus $C0681$ again, $CMP1-OUT$ changes from HIGH to LOW.

2.4.16.3 Function 3: $CMP1-IN1 < CMP1-IN2$

- Selection: $C0680 = 3$
- This function is used to find out whether the actual speed is lower than a limit value ($n_{act.} < n_x$) for one direction of rotation.

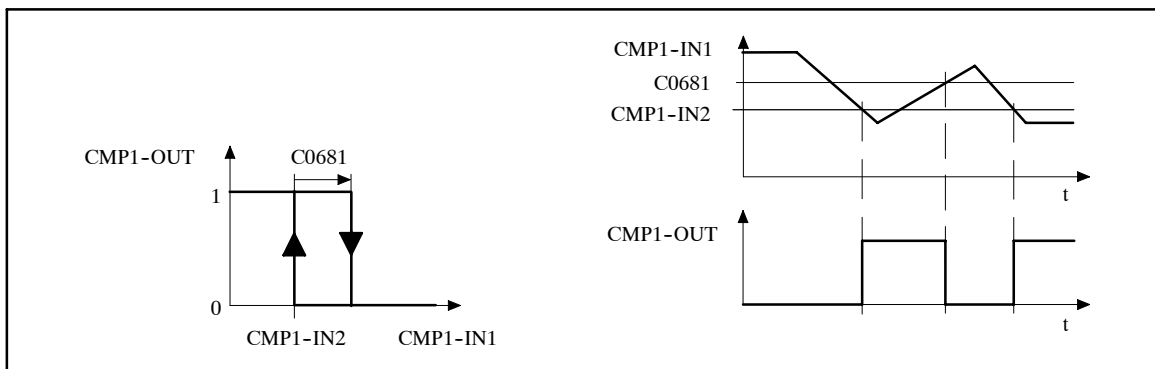
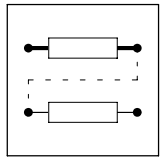

Fig. 2-56 Undershooting signal values ($CMP1-IN1 < CMP1-IN2$)

Function procedure

1. If the value at $CMP1-IN1$ falls below the value at $CMP1-IN2$, $CMP1-OUT$ changes from LOW to HIGH.
2. If the value at $CMP1-IN1$ exceeds the value at $CMP1-IN2$ plus $C0681$ again, $CMP1-OUT$ changes from HIGH to LOW.



2.4.16.4 Function 4: $|\text{CMP1-IN1}| = |\text{CMP1-IN2}|$

- Selection: C0680 = 4
- This function is used to carry out the comparison " $|n_{\text{act.}}| = |n_x|$ " for instance.
- This function is the same as function 1. (□ 2-73)
 - However, the absolute value of the input signals (without sign) is created before the signals are processed.

2.4.16.5 Function 5: $|\text{CMP1-IN1}| > |\text{CMP1-IN2}|$

- Selection: C0680 = 5
- This function is used to carry out the comparison " $|n_{\text{act.}}| > |n_x|$ " independently of the direction of rotation.
- This function is the same as function 3. (□ 2-74)
 - However, the absolute value of the input signals (without sign) is created before the signals are processed.

2.4.16.6 Function 6: $|\text{CMP1-IN1}| < |\text{CMP1-IN2}|$

- Selection: C0680 = 6
- This function is the same as function 2. (□ 2-74)
 - However, the absolute value of the input signals (without sign) is created before the signals are processed.
- This function is used to carry out the comparison " $|n_{\text{act.}}| < |n_x|$ " independently of the direction of rotation.

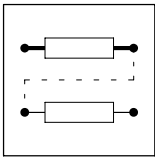

Configuration

Function blocks

2.4.17 Conversion (CONV)

These FBs convert analog signals or convert signals into another signal type. The conversion factor as numerator and denominator is calculated using residual value processing.

CONV1

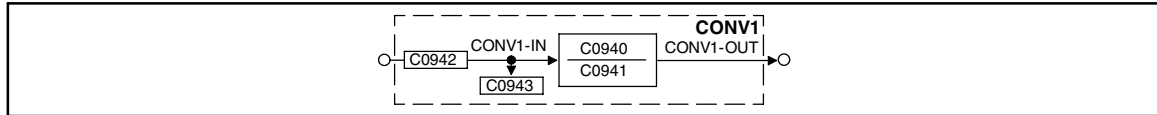

Fig. 2-57

Conversion (CONV1)

Name	Signal			Source			Note
	Type	DIS	DIS format	CFG	List	Lenze	
CONV1-IN	a	C0943	dec [%]	C0942	1	1000	
CONV1-OUT	a	-	-	-	-	-	Limited to ±199.99 %

This FB is used to multiply analog signals with a specified factor. The calculation is done according to the following formula:

$$\text{CONV1-OUT} = \text{CONV1-IN} \cdot \frac{\text{C0940}}{\text{C0941}}$$

Example:

- You want to multiply an analog signal with 1.12.
- For this, enter C0940 = 112 and C0941 = 100.

CONV2

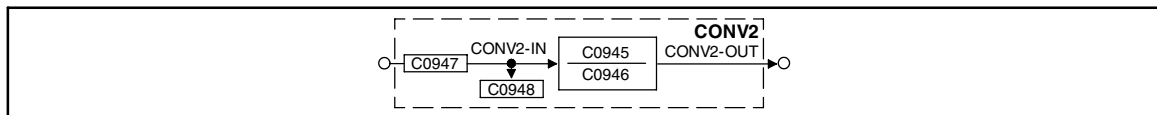

Fig. 2-58

Conversion (CONV2)

Name	Signal			Source			Note
	Type	DIS	DIS format	CFG	List	Lenze	
CONV2-IN	a	C0948	dec [%]	C0947	1	1000	
CONV2-OUT	a	-	-	-	-	-	Limited to ±199.99 %

This FB is used to multiply analog signals with a specified factor. The calculation is done according to the following formula:

$$\text{CONV2-OUT} = \text{CONV2-IN} \cdot \frac{\text{C0945}}{\text{C0946}}$$

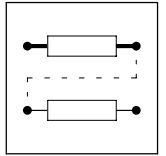

CONV3

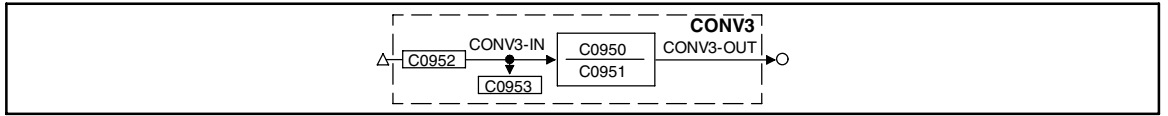

Fig. 2-59

Conversion (CONV3)

Name	Signal			Source			Note
	Type	DIS	DIS format	CFG	List	Lenze	
CONV3-IN	phd	C0953	dec [rpm]	C0952	4	1000	
CONV3-OUT	a	-	-	-	-	-	Limited to ±199.99 %

This FB is used to convert speed signals into analog signals. The conversion is done according to the formula:

$$\text{CONV3-OUT} = \text{CONV3-IN} \cdot \frac{100 \%}{15000 \text{ rpm}} \cdot \frac{\text{C0950}}{\text{C0951}}$$

CONV4

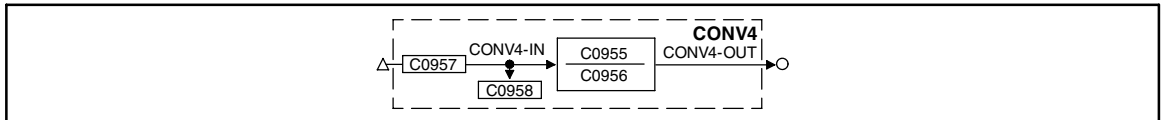

Fig. 2-60

Conversion (CONV4)

Name	Signal			Source			Note
	Type	DIS	DIS format	CFG	List	Lenze	
CONV4-IN	phd	C0958	dec [rpm]	C0957	4	1000	
CONV4-OUT	a	-	-	-	-	-	Limited to ±199.99 %

This FB is used to convert speed signals into analog signals. The conversion is done according to the formula:

$$\text{CONV4-OUT} = \text{CONV4-IN} \cdot \frac{100 \%}{15000 \text{ rpm}} \cdot \frac{\text{C0955}}{\text{C0956}}$$

CONV5

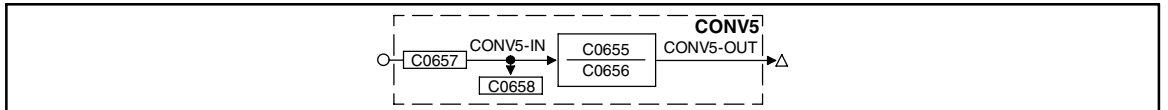

Fig. 2-61

Conversion (CONV5)

Name	Signal			Source			Note
	Type	DIS	DIS format	CFG	List	Lenze	
CONV5-IN	a	C0658	dec [%]	C0657	1	1000	
CONV5-OUT	phd	-	-	-	-	-	Limited to ±29999 rpm

This FB is used to convert analog signals into speed signals. The conversion is done according to the formula:

$$\text{CONV5-OUT} = \text{CONV5-IN} \cdot \frac{15000 \text{ rpm}}{100 \%} \cdot \frac{\text{C0655}}{\text{C0656}}$$

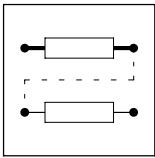

Configuration

Function blocks

2.4.18 Conversion phase to analog (CONVPHA)

This FB converts a phase signal into an analog signal.

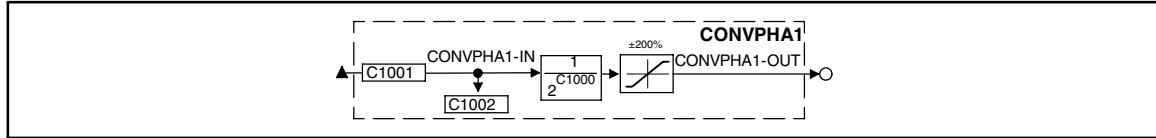

Fig. 2-62

Conversion phase to analog (CONVPHA1)

Name	Signal			Source			Note
	Type	DIS	DIS format	CFG	List	List	
CONVPHA1-IN	ph	C1002	dec [inc]	C1001	3	1000	-
CONVPHA1-OUT	a	-	-	-	-	-	limited to ±200 %, residual value processing

Function

- The conversion with adaptation using divisor is as follows:

$$\text{CONVPHA1-OUT} = \text{CONVPHA1-IN [inc]} \cdot \frac{100 \%}{2^{14} \cdot 2^{C1000}}$$

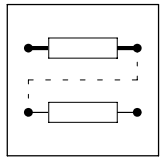

2.4.19 Characteristic function (CURVE)

This FB converts analog signals according to the programmed characteristic.

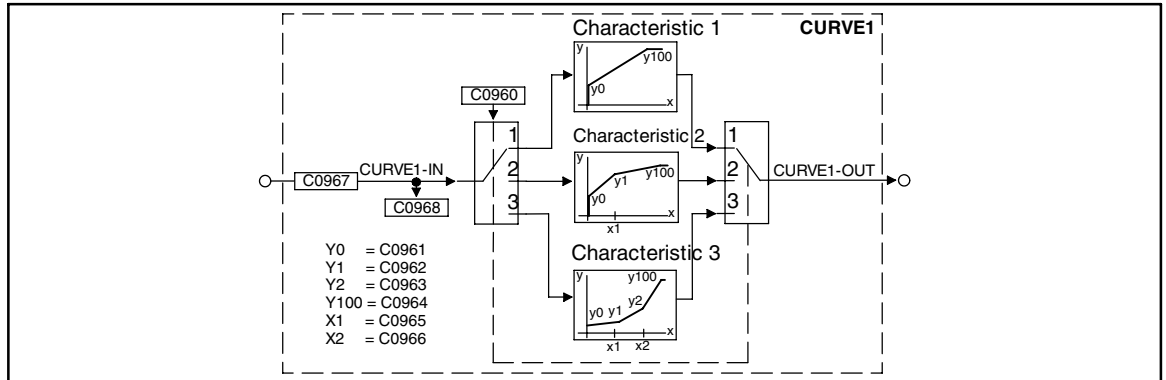

Fig. 2-63 Characteristic function (CURVE1)

Name	Signal			Source			Note
	Type	DIS	DIS format	CFG	List	Lenze	
CURVE1-IN	a	C0968	dec [%]	C0967	1	5001	-
CURVE1-OUT	a	-	-	-	-	-	-

Range of functions

- Characteristic with two co-ordinates
- Characteristic with three co-ordinates
- Characteristic with four co-ordinates

Function

- A linear interpolation is carried out between the co-ordinates.
- For negative values at CURVE1-IN, setting values of the interpolation points are processed as inverted values (see diagrams).
 - If this is not desired, add an ABS or a LIM function block in front of or behind the CURVE function block.

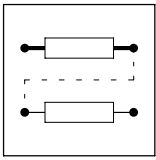

Configuration

Function blocks

2.4.19.1 Characteristic with two co-ordinates

C0960 = 1

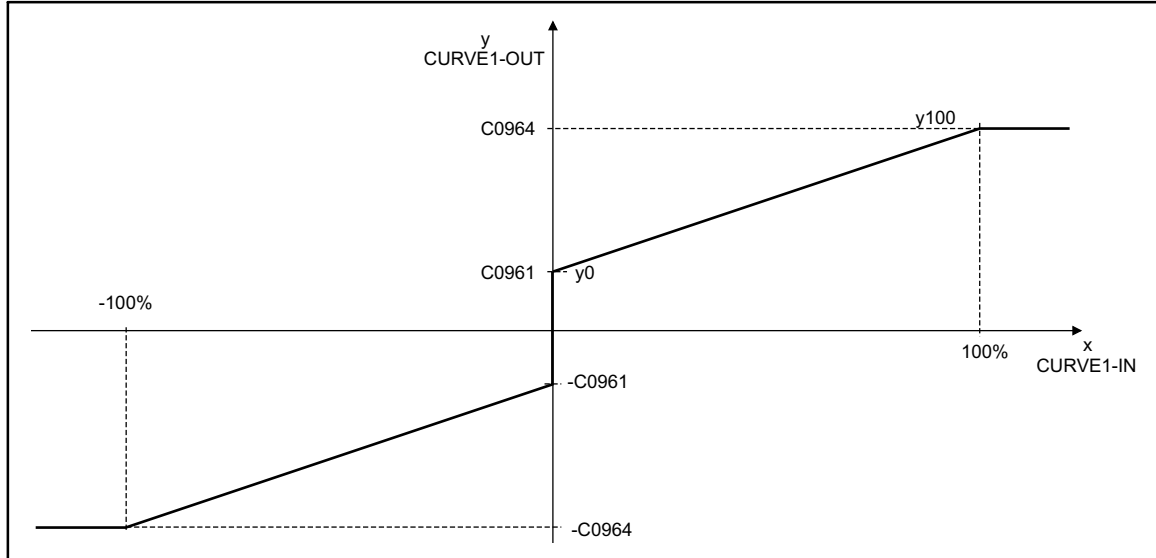

Fig. 2-64 Characteristic with two co-ordinates

2.4.19.2 Characteristic with three co-ordinates

C0960 = 2

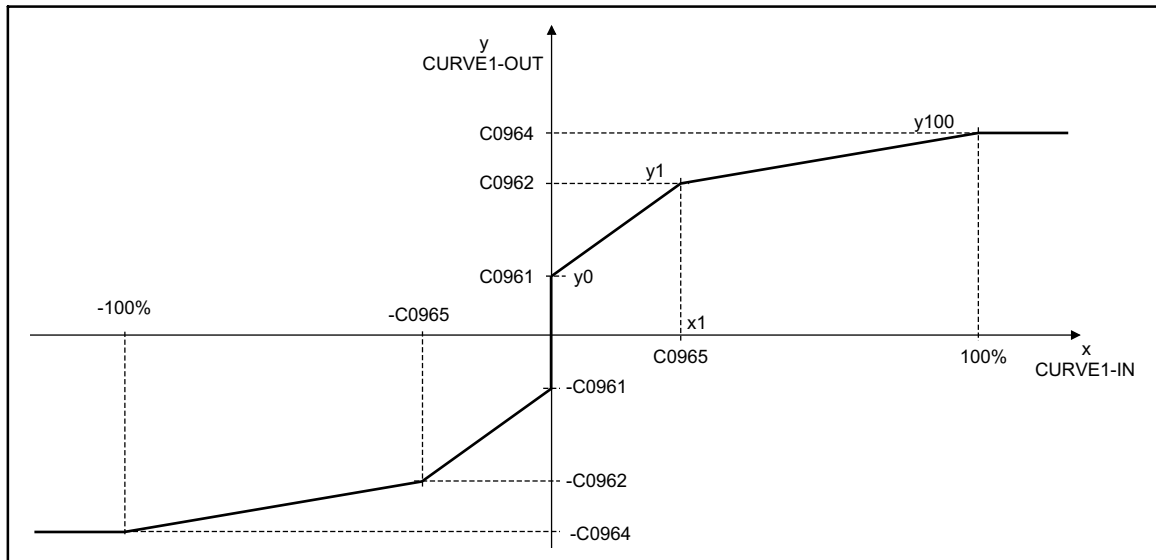
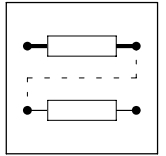

Fig. 2-65 Characteristic with three co-ordinates



2.4.19.3 Characteristic with four co-ordinates

C0960 = 3

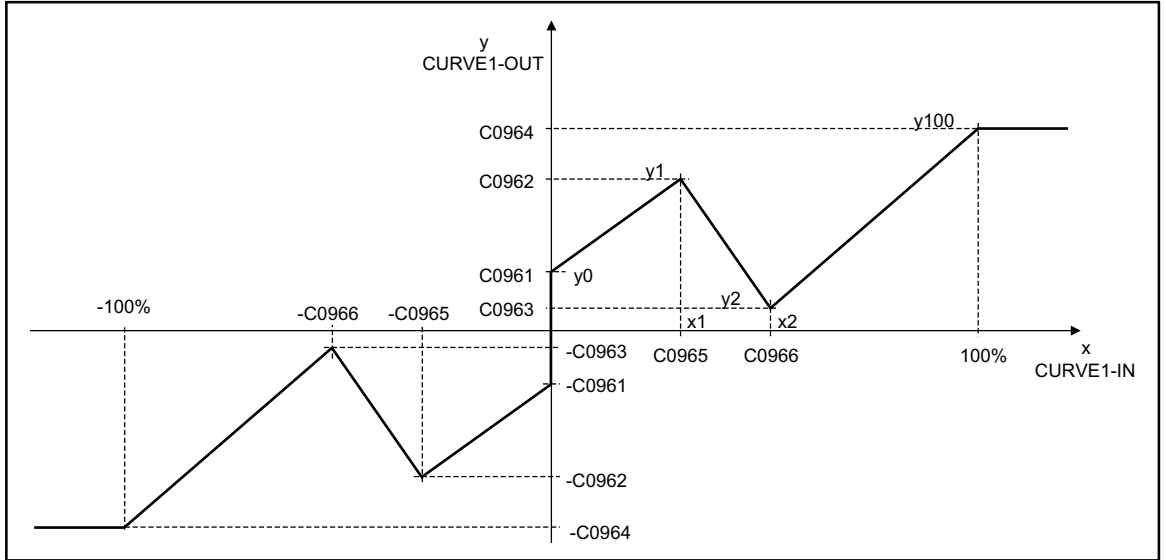
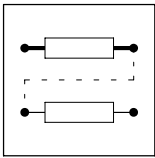

Fig. 2-66 Characteristic with four co-ordinates



Configuration

Function blocks

2.4.20 Dead band (DB)

This FB eliminates input signals around the zero point (e.g. disturbances on analog input voltages).

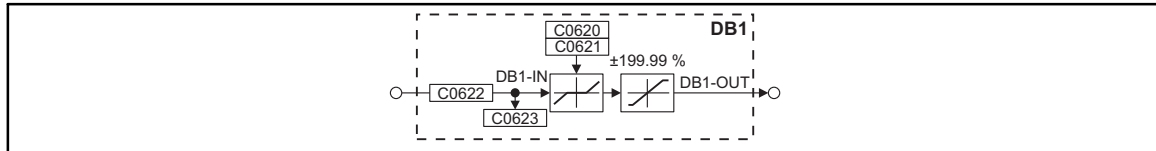

Fig. 2-67

Dead band (DB1)

Name	Signal			Source			Note
	Type	DIS	DIS format	CFG	List	Lenze	
DB1-IN	a	C0623	dec [%]	C0622	1	1000	-
DB1-OUT	a	-	-	-	-	-	limited to $\pm 199.99\%$

Function

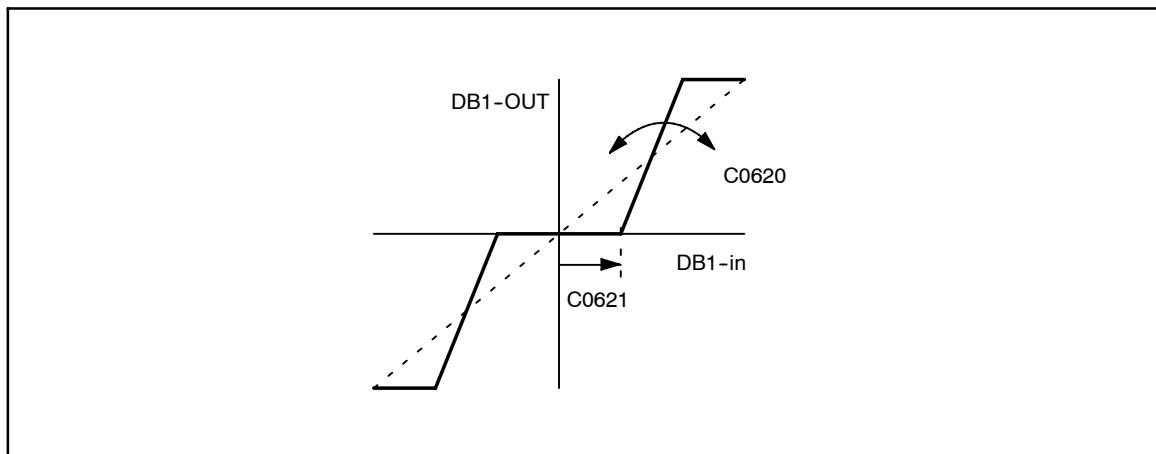
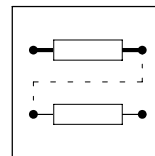

Fig. 2-68

Dead band and gain

- Under C0621 you can set the parameters for the dead band.
- Under C0620 you can alter the gain.



2.4.21 Diameter calculator (DCALC)

For the function block description, please see the corresponding System Manual:

- EVF9321 ... EVF9333 controllers
 - System Manual with document number EDSVF9333V
- EVF9335 ... EVF9338 and EVF9381 ... EVF9383 controllers
 - System Manual with document number EDSVF9383V

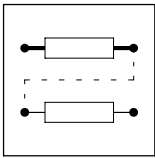

Configuration

Function blocks

2.4.22 Device control (DCTRL)

This FB controls the device to specified states (e.g. trip, trip reset, quick stop or controller inhibit).

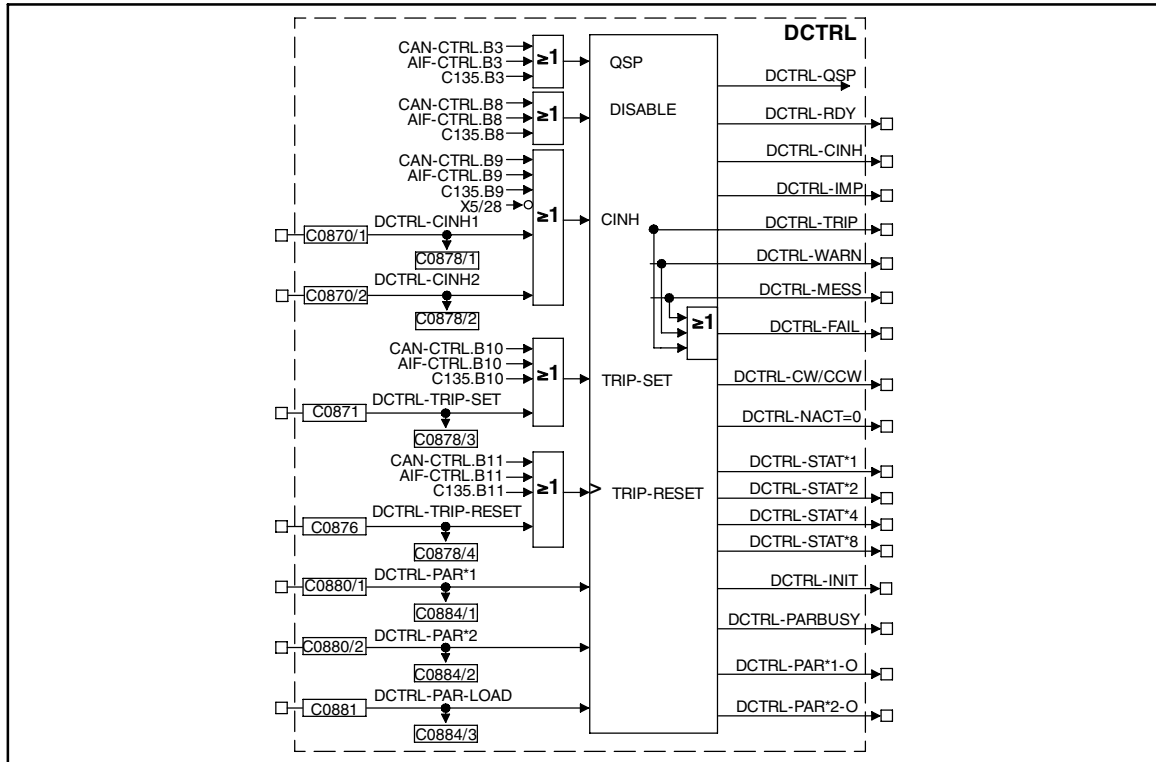
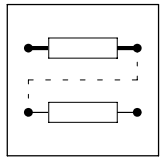

Fig. 2-69 Device control (DCTRL)



Name	Signal			Source			Note
	Type	DIS	DIS format	CFG	List	Lenze	
DCTRL-CINH1	d	C0878/1	bin	C0870/1	2	1000	HIGH = inhibit controller
DCTRL-CINH2	d	C0878/2	bin	C0870/2	2	1000	HIGH = inhibit controller
DCTRL-TRIP-SET	d	C0878/3	bin	C0871	2	54	HIGH = fault indication EEr
DCTRL-TRIPRESET	d	C0878/4	bin	C0876	2	55	LOW-HIGH signal = Trip reset
DCTRL-PAR*1	d	C0884/1	bin	C0880/1	2	1000	Select parameter set
DCTRL-PAR*2	d	C0884/2	bin	C0880/2	2	1000	Select parameter set
DCTRL-PAR-LOAD	d	C0884/3	bin	C0881	2	1000	LOW-HIGH signal = Load parameter set
DCTRL-RDY	d	-	-	-	-	-	HIGH = Ready for operation
DCTRL-CINH	d	-	-	-	-	-	HIGH = Controller reset
DCTRL-IMP	d	-	-	-	-	-	HIGH = High-resistance power output stages
DCTRL-TRIP	d	-	-	-	-	-	HIGH = Active fault
DCTRL-WARN	d	-	-	-	-	-	HIGH = Active warning
DCTRL-MESS	d	-	-	-	-	-	HIGH = Active message
DCTRL-FAIL	d	-	-	-	-	-	-
DCTRL-CW/CCW	d	-	-	-	-	-	LOW = CW rotation, HIGH = CCW rotation
DCTRL-NACT=0	d	-	-	-	-	-	HIGH = Motor speed < C0019
DCTRL-STAT*1	d	-	-	-	-	-	general status (binary coded)
DCTRL-STAT*2	d	-	-	-	-	-	general status (binary coded)
DCTRL-STAT*4	d	-	-	-	-	-	general status (binary coded)
DCTRL-STAT*8	d	-	-	-	-	-	general status (binary coded)
DCTRL-INIT	d	-	-	-	-	-	-
DCTRL-PARBUSY	d	-	-	-	-	-	HIGH = Change of parameter set active
DCTRL-PAR*1-0	d	-	-	-	-	-	Parameter set X active (binary coded)
DCTRL-PAR*2-0	d	-	-	-	-	-	Parameter set X active (binary coded)

Range of functions

- Quick stop (QSP)
- Operation inhibited (DISABLE)
- Controller inhibit (CINH)
- TRIP-SET
- TRIP-RESET
- Changing the parameter set (PAR)
- Controller state

2.4.22.1 Quick stop (QSP)

If QSP is activated, the drive is decelerated to zero speed via the deceleration ramp C0105.

- QSP is activated via three inputs:
 - Control word CAN-CTRL.B3 from CAN-IN1
 - Control word AIF-CTRL.B 3 from AIF-IN
 - Control word C0135.B3
- All inputs are linked by an OR-operation
- QSP can also be activated via the input MCTRL-QSP in the FB MCTRL.

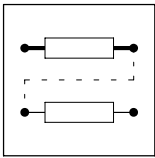

Configuration

Function blocks

2.4.22.2 Operating inhibited (DISABLE)

When the operation is inhibited, the output stages are inhibited and all controllers are reset. When the operation is inhibited, the drive cannot be started by the controller enable command.

- The function is activated via three inputs:
 - Control word CAN-CTRL.B8 from CAN-IN1
 - Control word AIF-CTRL.B8 from AIF-IN
 - Control word C0135.B8
- All inputs are linked by an OR-operation.

2.4.22.3 Controller inhibit (CINH)

When the controller is inhibited, the output stages are inhibited and all controllers are reset.

- The function is activated via six inputs:
 - Terminal X5/28 (LOW = controller inhibit)
 - Control word CAN-CTRL.B9 from CAN-IN1
 - Control word AIF-CTRL.B9 from AIF-IN
 - Control word C0135.B9
 - Free inputs DCTRL-CINH1 and DCTRL-CINH2
- All inputs are linked by an OR-operation.

2.4.22.4 TRIP-SET

The drive is controlled into the state under C0581 and indicates EEr (external monitoring).

- The function is activated via four inputs:
 - Control word CAN-CTRL.B10 from CAN-IN1
 - Control word AIF-CTRL.B10 from AIF-IN
 - Control word C0135.B10
 - Free input DCTRL-TRIP-SET
- All inputs are linked by an OR-operation.

2.4.22.5 TRIP-RESET

TRIP-RESET resets an active trip once the cause of fault has been eliminated. If the cause of fault is still active, there is no reaction.

- The function is activated via four inputs:
 - Control word CAN-CTRL.B11 from CAN-IN1
 - Control word AIF-CTRL.B11 from AIF-IN
 - Control word C0135.B11
 - Free input DCTRL-TRIP-RESET
- All inputs are linked by an OR-operation.
- The function can only be performed by a LOW-HIGH edge of the signal resulting from the OR operation.



Tip!

If one of the inputs is set to HIGH, no LOW-HIGH edge can occur at the resulting signal.

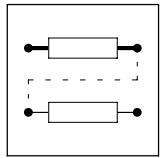

2.4.22.6 Changing the parameter set (PAR)

The controller loads and uses the selected parameter set.

- The parameter set to be loaded is selected via the inputs DCTRL-PAR*1 and DCTRL-PAR*2. The inputs are binary coded (1 of 4).

PAR*2	PAR*1	Selected parameter set
0	0	Parameter set 1
0	1	Parameter set 2
1	0	Parameter set 3
1	1	Parameter set 4

- With a LOW-HIGH - signal at the input DCTRL-PAR-LOAD the controller changes to the selected parameter set.
- The parameter set can be changed only if the controlled inhibit is activated. (2-86)



Tip!

If the parameter set to be loaded via terminal X5/Ex is selected before connecting the supply voltage, the LOW-HIGH signal at the input DCTRL-PAR-LOAD is not necessary. In this case, the controller loads automatically the selected parameter set.

- The controller is not ready for approx. 1 s. DCTRL- RDY shows LOW during this time.

2.4.22.7 Controller state

The state is binary coded in the outputs DCTRL-STAT*x.

STAT*8	STAT*4	STAT*2	STAT*1	Action of the controller
0	0	0	0	Initialization after connection of the supply voltage
0	0	0	1	Lock mode, Protection against restart active C0142
0	0	1	1	Drive is in controller inhibit mode
0	1	1	0	Controller enabled
0	1	1	1	The release of a monitoring function resulted in a "message"
1	0	0	0	The release of a monitoring function resulted in a "trip"

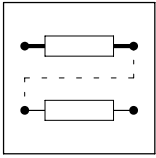

Configuration

Function blocks

2.4.23 Digital frequency input (DFIN)

For the function block description, please see the corresponding System Manual:

- EVF9321 ... EVF9333 controllers
 - System Manual with document number EDSVF9333V
- EVF9335 ... EVF9338 and EVF9381 ... EVF9383 controllers
 - System Manual with document number EDSVF9383V

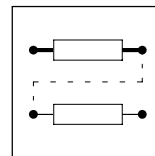

2.4.24 Digital frequency output (DFOUT)

For the function block description, please see the corresponding System Manual:

- EVF9321 ... EVF9333 controllers
 - System Manual with document number EDSVF9333V
- EVF9335 ... EVF9338 and EVF9381 ... EVF9383 controllers
 - System Manual with document number EDSVF9383V

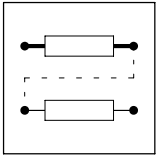

Configuration

Function blocks

2.4.25 Digital frequency ramp function generator (DFRFG)

For the function block description, please see the corresponding System Manual:

- EVF9321 ... EVF9333 controllers
 - System Manual with document number EDSVF9333V
- EVF9335 ... EVF9338 and EVF9381 ... EVF9383 controllers
 - System Manual with document number EDSVF9383V

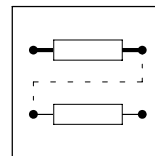

2.4.26 Digital frequency processing (DFSET)

For the function block description, please see the corresponding System Manual:

- EVF9321 ... EVF9333 controllers
 - System Manual with document number EDSVF9333V
- EVF9335 ... EVF9338 and EVF9381 ... EVF9383 controllers
 - System Manual with document number EDSVF9383V

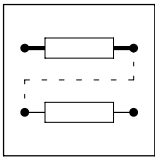

Configuration

Function blocks

2.4.27 Delay (DIGDEL)

These FBs delay digital signals. You can use the FB for the control of other functions or the generation of status information.

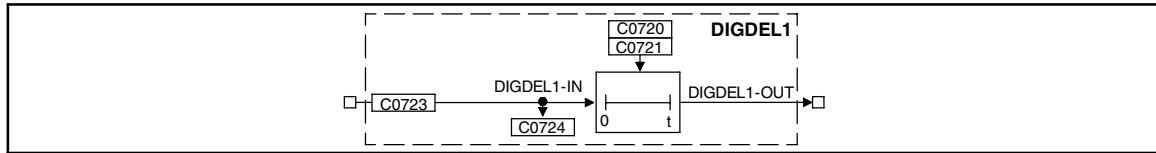

Fig. 2-70

Delay (DIGDEL1)

Name	Signal			Source			Note
	Type	DIS	DIS format	CFG	List	Lenze	
DIGDEL1-IN	d	C0724	bin	C0723	2	1000	-
DIGDEL1-OUT	d	-	-	-	-	-	-

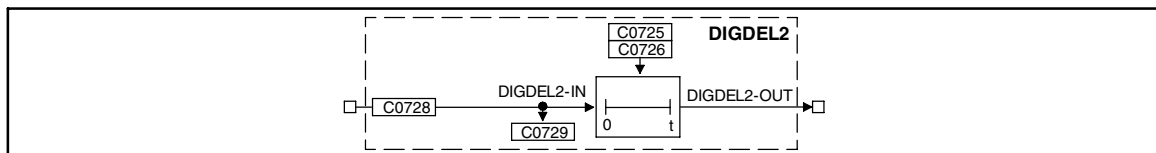

Fig. 2-71

Delay (DIGDEL2)

Name	Signal			Source			Note
	Type	DIS	DIS format	CFG	List	Lenze	
DIGDEL2-IN	d	C0729	bin	C0728	2	1000	-
DIGDEL2-OUT	d	-	-	-	-	-	-

Range of functions

- On-delay
- Off-delay
- General delay

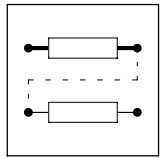

2.4.27.1 On-delay

- C0720 = 0 (DIGDEL1)
- C0725 = 0 (DIGDEL2)

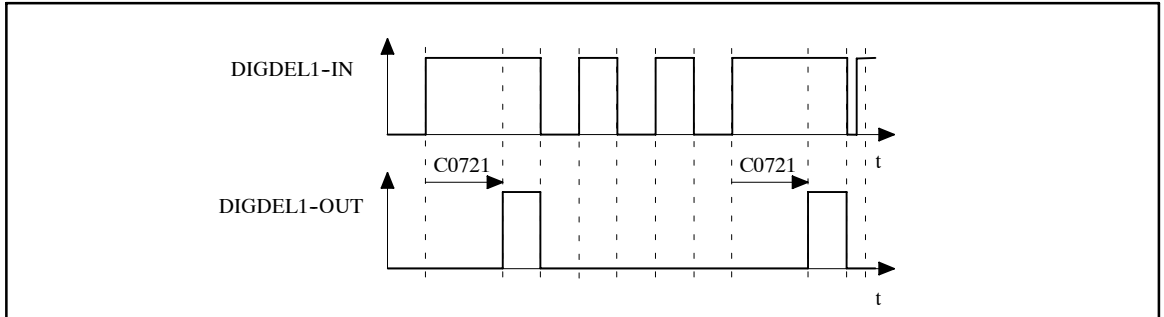

Fig. 2-72

On-delay (DIGDEL1)

In this function, the time-element operates like a retriggerable monoflop:

Function procedure

1. A LOW-HIGH edge at DIGDELx-IN starts the time element.
2. After the delay set under C0721 (DIGDEL1) or C0726 (DIGDEL2) has elapsed, DIGDELx-OUT changes to HIGH.
3. A HIGH-LOW signal at DIGDELx-IN resets the time element and changes DIGDELx-OUT to LOW.

2.4.27.2 Off-delay

- C0720 = 1 (DIGDEL1)
- C0725 = 1 (DIGDEL2)

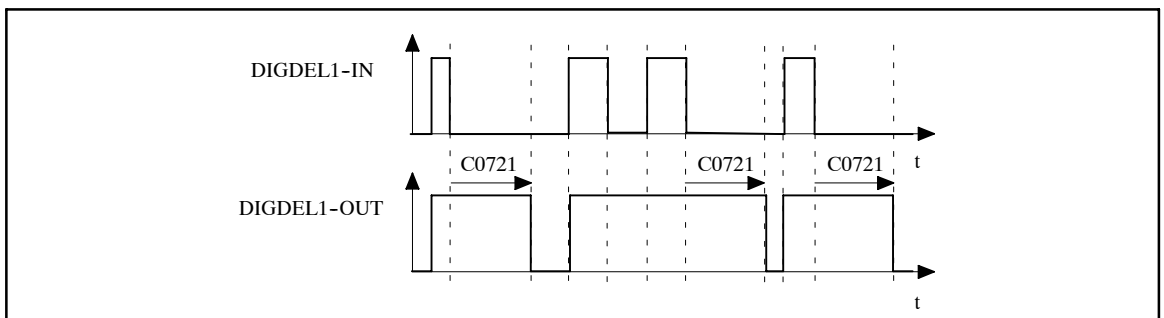
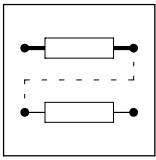

Fig. 2-73

Off-delay (DIGDEL1)

Function procedure

1. A LOW-HIGH signal at DIGDELx-IN changes DIGDELx-OUT to HIGH and resets the time element.
2. A HIGH-LOW signal at DIGDELx-IN starts the time element.
3. After the delay set under C0721 (DIGDEL1) or C0726 (DIGDEL2) has elapsed, DIGDELx-OUT changes to LOW.



Configuration

Function blocks

2.4.27.3 General delay

- C0720 = 2 (DIGDEL1)
- C0725 = 2 (DIGDEL2)

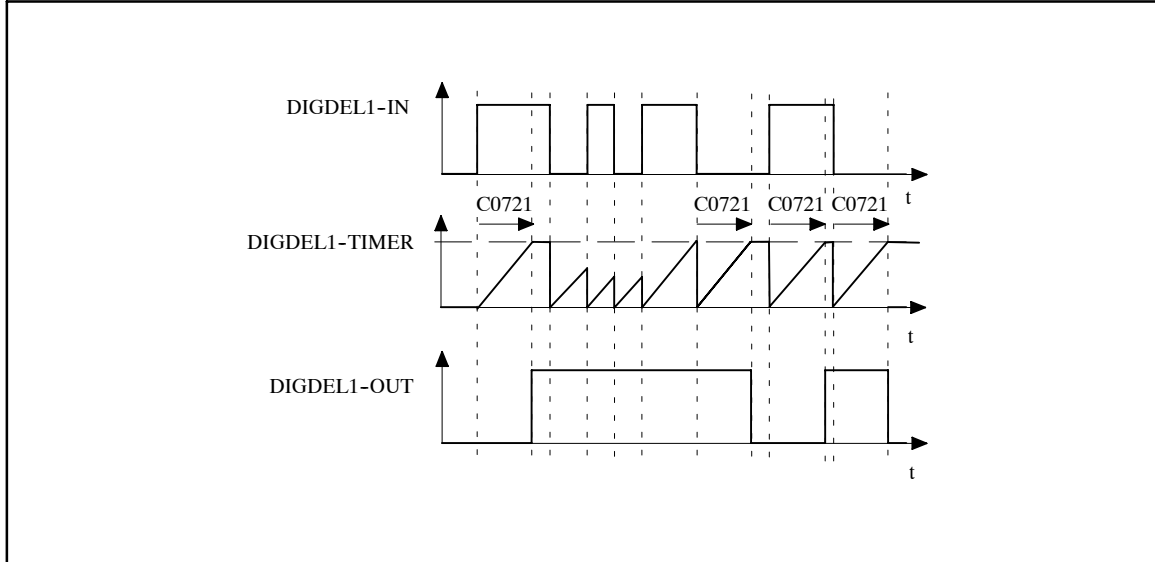
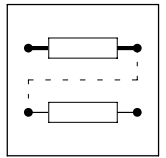

Fig. 2-74

General delay (DIGDEL1)

Function procedure

1. Any signal at DIGDELx-IN starts the time element.
2. When the timer has reached the upper limit (DIGDEL1: C0721, DIGDEL2: C0726), DIGDELx-OUT is set to the same value applied at DIGDELx-IN.



2.4.28 Digital inputs (DIGIN)

This FB reads digital signals at the terminals X5/E1 ... X5/E5 and X5/ST and conditions them.

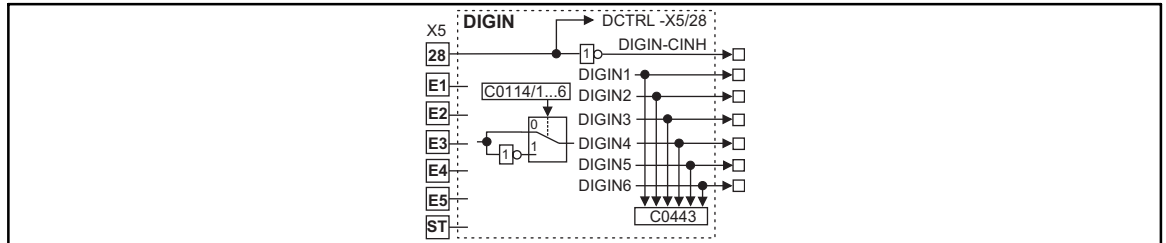

Fig. 2-75

Digital inputs (DIGIN)

Name	Signal			Source			Note
	Type	DIS	DIS format	CFG	List	Lenze	
DIGIN-CINH	d	-	dec	-	-	-	Controller inhibit acts directly on the DCTRL control
DIGIN1	d	C0443	dec	-	-	-	-
DIGIN2	d	C0443	dec	-	-	-	-
DIGIN3	d	C0443	dec	-	-	-	-
DIGIN4	d	C0443	dec	-	-	-	-
DIGIN5	d	C0443	dec	-	-	-	-
DIGIN6	d	C0443	dec	-	-	-	-

Function

The terminals X5/E1 to X5/E5 and X5/ST are scanned every millisecond. The level for every input can be inverted.

- Select the desired input under C0114 with the corresponding subcode (e.g. subcode C0114/3 for input X5/E3)
- Select the desired level:
 - 0 = Level not inverted (HIGH active)
 - 1 = Level inverted (LOW active)

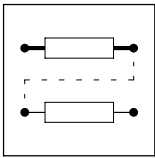

Configuration

Function blocks

2.4.29 Digital outputs (DIGOUT)

This FB conditions digital signals and output them at terminals X5/A1 ... X5/A4.

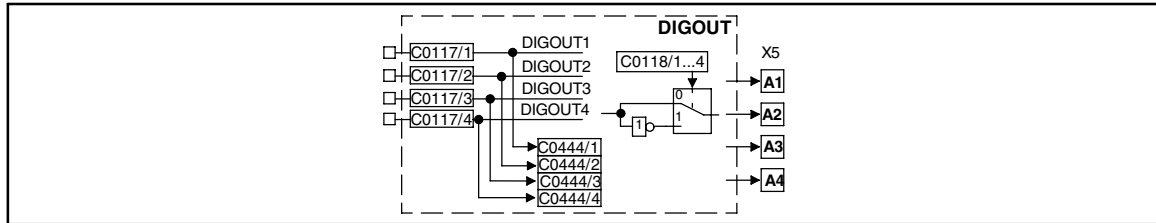

Fig. 2-76

Digital outputs (DIGOUT)

Name	Signal			Source			Note
	Type	DIS	DIS format	CFG	List	Lenze	
DIGOUT1	d	C0444/1	bin	C0117/1	2	15000	-
DIGOUT2	d	C0444/2	bin	C0117/2	2	10650	-
DIGOUT3	d	C0444/3	bin	C0117/3	2	500	-
DIGOUT4	d	C0444/4	bin	C0117/4	2	5003	-

Function

The terminals X5/A1 to X5/A4 are updated every millisecond. The level for every output can be inverted.

- Select the desired output under C0118 with the corresponding subcode (e.g. subcode C0118/3 for output X5/A3)
- Select the desired level:
 - 0 = Level not inverted (HIGH active)
 - 1 = Level inverted (LOW active)

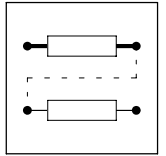

2.4.30 Differentiation (DT1-1)

This FB differentiates signals. You can, for instance, calculate the controller acceleration (dv/dt) required for applying an acceleration.

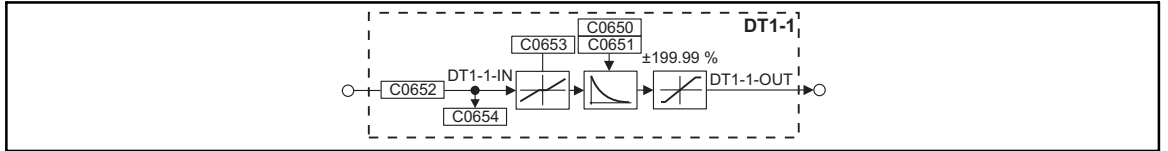

Fig. 2-77

Differentiation (DT1-1)

Name	Signal			Source			Note
	Type	DIS	DIS format	CFG	List	Lenze	
DT1-1-IN	a	C0654	dec [%]	C0652	1	1000	-
DT1-1-OUT	a	-	-	-	-	-	limited to ±199.99 %

Function

- The gain K is selected under C0650.
- The delay time T_v is selected under C0651.
- The input sensitivity can be reduced under C0653.
 - According to the setting, the FB only evaluates the most significant bits specified.

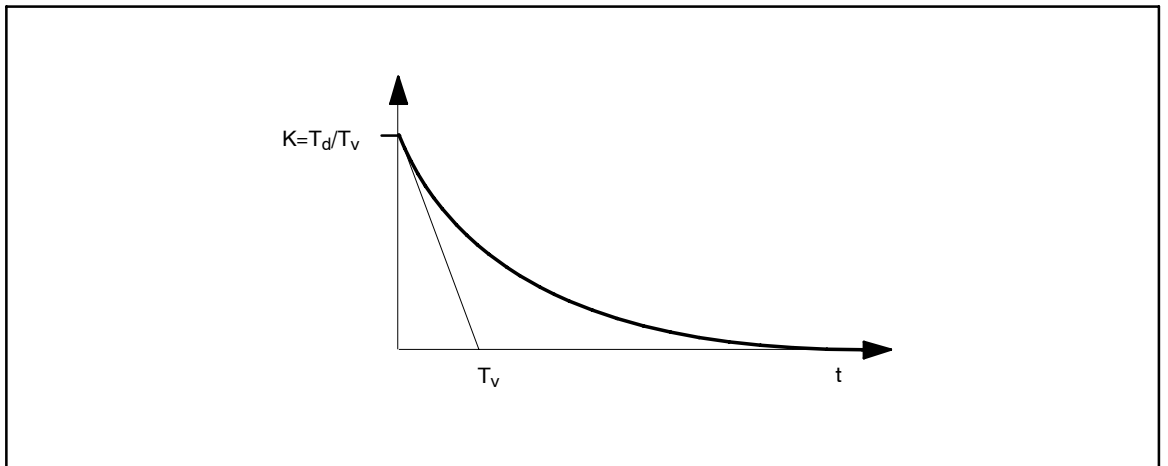
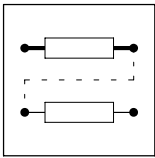

Fig. 2-78

Delay time T_v



Configuration

Function blocks

2.4.31 Counter (FCNT)

This FB is used for digital counting up and down.

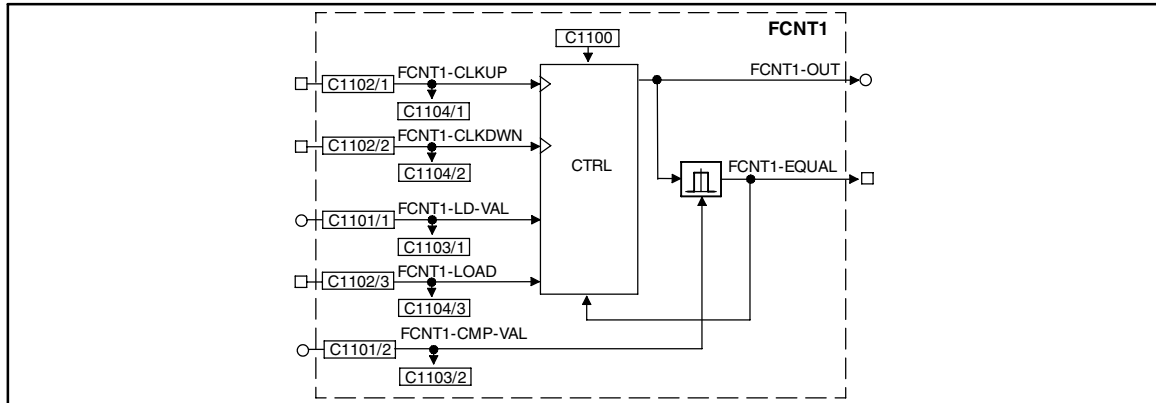

Fig. 2-79 Counter (FCNT1)

Name	Signal			Source		Note
	Type	DIS	DIS format	CFG	List	
FCNT1-CLKUP	d	C1104/1	bin	C1102/1	2	LOW-HIGH edge = counts up by 1
FCNT1-CLKDWN	d	C1104/2	bin	C1102/2	2	LOW-HIGH edge = counts down by 1
FCNT1-LD-VAL	a	C1103/1	dec	C1101/1	1	Start value
FCNT1-LOAD	d	C1104/3	bin	C1102/3	2	<ul style="list-style-type: none"> ● HIGH = Accept start value ● The input has the highest priority
FCNT1-CMP-VAL	a	C1103/2	dec	C1101/2	1	Comparison value
FCNT1-OUT	a	-	-	-	-	Counter limited to $\pm 199.99\%$
FCNT1-EQUAL	d	-	-	-	-	HIGH = comparison value reached

Range of functions

- Setting start value
- Counting up/down
- Comparing counter

2.4.31.1 Setting start value

The counter is initialized with defined values via the inputs FCNT1-LD-VAL and FCNT1-LOAD.

- As long as FCNT1-LOAD = HIGH, the value at FCNT1-LD-VAL (start value) is switched to FCNT1-OUT.
- When FCNT1-LOAD = LOW, the counter is enabled for counting up and down.
- When FCNT1-LOAD = HIGH, the counter is reset to the value at FCNT1-LD-VAL.

2.4.31.2 Counting up/down

- A LOW-HIGH signal at FCNT1-CLKUP increases the counter by 1.
- A LOW-HIGH signal at FCNT1-CLKDWN reduces the counter by 1.

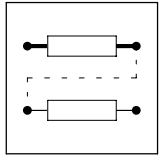

2.4.31.3 Comparing counter

C1100 = 1

- If $|\text{FCNT1-OUT}| \geq |\text{FCNT1-CMP-VAL}|$:
 - FCNT1-EQUAL = HIGH for 1 ms.
 - The counter is reset to the start value at FCNT1-LD-VAL.



Tip!

If the signal at FCNT1-EQUAL is to be set for a longer time, e.g. when the output is requested by a PLC, you can extend the signal with the TRANS function block.

C1100 = 2

- If $|\text{FCNT1-OUT}| = |\text{FCNT1-CMP-VAL}|$:
 - The counter is stopped.

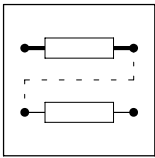

Configuration

Function blocks

2.4.32 Free digital outputs (FDO)

This FB is used to link free digital signals which are to be transmitted to a field bus.

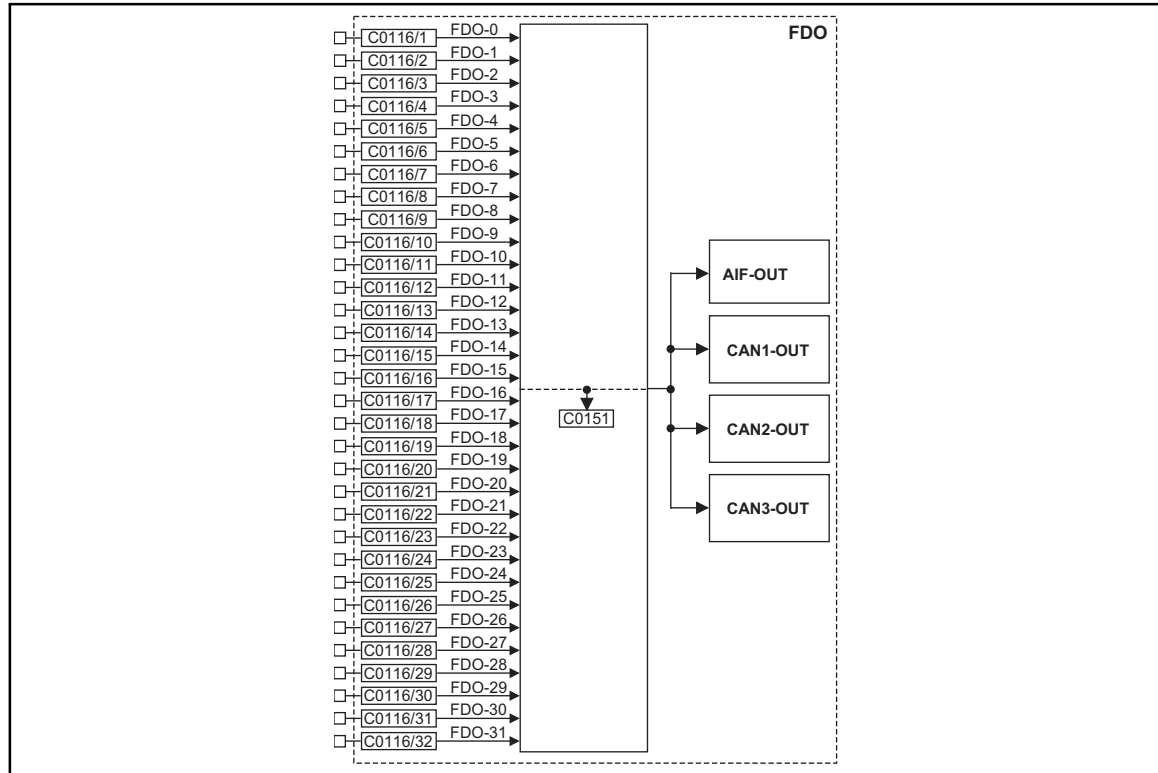
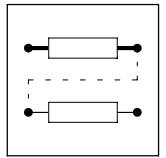

Fig. 2-80 Free digital outputs (FDO)



Name	Signal			Source			Note
	Type	DIS	DIS format	CFG	List	Lenze	
FDO-0	d	C0151	hex	C0116/1	2	1000	
FDO-1	d	C0151	hex	C0116/2	2	1000	
FDO-2	d	C0151	hex	C0116/3	2	1000	
FDO-3	d	C0151	hex	C0116/4	2	1000	
FDO-4	d	C0151	hex	C0116/5	2	1000	
FDO-5	d	C0151	hex	C0116/6	2	1000	
FDO-6	d	C0151	hex	C0116/7	2	1000	
FDO-7	d	C0151	hex	C0116/8	2	1000	
FDO-8	d	C0151	hex	C0116/9	2	1000	
FDO-9	d	C0151	hex	C0116/10	2	1000	
FDO-10	d	C0151	hex	C0116/11	2	1000	
FDO-11	d	C0151	hex	C0116/12	2	1000	
FDO-12	d	C0151	hex	C0116/13	2	1000	
FDO-13	d	C0151	hex	C0116/14	2	1000	
FDO-14	d	C0151	hex	C0116/15	2	1000	
FDO-15	d	C0151	hex	C0116/16	2	1000	
FDO-16	d	C0151	hex	C0116/17	2	1000	
FDO-17	d	C0151	hex	C0116/18	2	1000	
FDO-18	d	C0151	hex	C0116/19	2	1000	
FDO-19	d	C0151	hex	C0116/20	2	1000	
FDO-20	d	C0151	hex	C0116/21	2	1000	
FDO-21	d	C0151	hex	C0116/22	2	1000	
FDO-22	d	C0151	hex	C0116/23	2	1000	
FDO-23	d	C0151	hex	C0116/24	2	1000	
FDO-24	d	C0151	hex	C0116/25	2	1000	
FDO-25	d	C0151	hex	C0116/26	2	1000	
FDO-26	d	C0151	hex	C0116/27	2	1000	
FDO-27	d	C0151	hex	C0116/28	2	1000	
FDO-28	d	C0151	hex	C0116/29	2	1000	
FDO-29	d	C0151	hex	C0116/30	2	1000	
FDO-30	d	C0151	hex	C0116/31	2	1000	
FDO-31	d	C0151	hex	C0116/32	2	1000	

Function

You can freely select a digital signal source for every signal input.

- The corresponding bit in the data word is marked with FDO-x (e.g. FDO-0 for the LSB and FDO-31 for the MSB).
- The data word is transferred to the function blocks AIF-OUT, CAN-OUT1, CAN-OUT2, and CAN-OUT3.

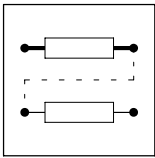

Configuration

Function blocks

2.4.33 Code assignment (FEVAN)

This FB transfers analog signals to any code. At the same time, it converts the signal to the data format of the target code.

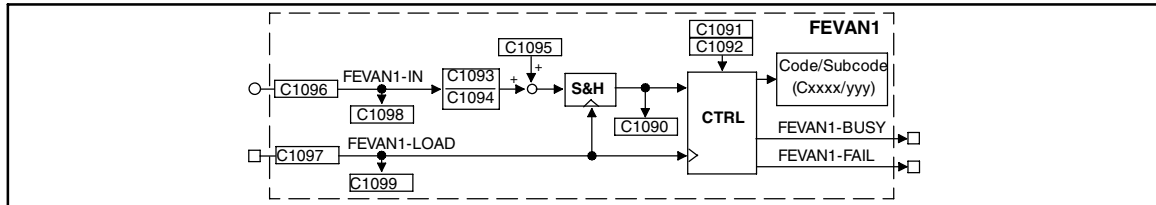
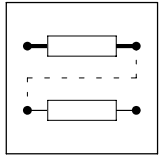

Fig. 2-81 Code assignment (FEVAN1)

Name	Signal			Source		Note
	Type	DIS	DIS format	CFG	List	
FEVAN1-IN	a	C1098	dec	C1096	1	Input value
FEVAN1-LOAD	d	C1099	bin	C1097	2	A LOW-HIGH edge transmits the converted signal to the target code.
FEVAN1-BUSY	d	-	-	-	-	HIGH = transmitting
FEVAN1-FAIL	d	-	-	-	-	<ul style="list-style-type: none"> HIGH = transmission failed - A LOW-HIGH edge at FEVAN1-LOAD switches FEVAN1-FAIL = LOW.
-	-	C1090	-	-	-	Display of the converted signal

Range of functions

- Data transmission
- Conversion



2.4.33.1 Data transmission

The data transmission is started with a LOW-HIGH signal at FEVAN1-LOAD. FEVAN1-BUSY = HIGH is set for the time of transmission.

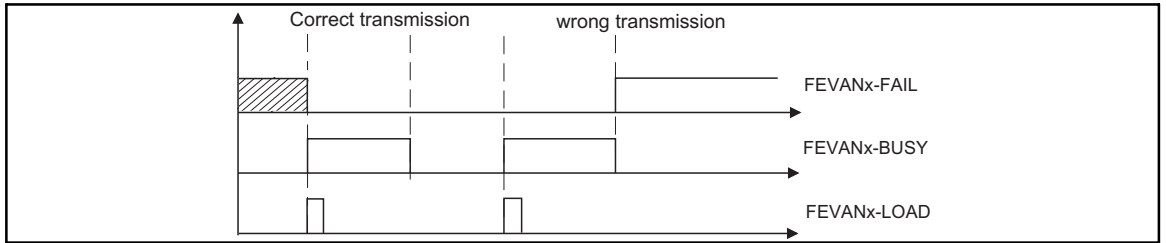

Fig. 2-82 Signal flow

Transmission errors can occur, if:

- the target code is not available
- the target subcode is not available
- the transmitted data are out of the target code limits
- the target code is inhibited since it can only be written if the controller is inhibited. Inhibit the controller (see code table).

Cyclic data transmission

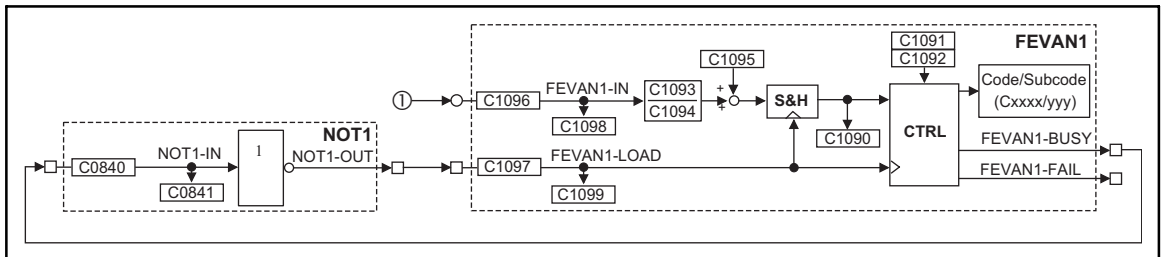
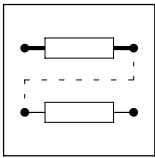

Fig. 2-83 Example for a cycle data transmission to a target code

- ① Input signal which is to be transmitted to the target code



Configuration

Function blocks

2.4.33.2 Conversion

The analog input signal at FEVAN1-IN is converted into the corresponding value of the target using C1093 (numerator) and C1094 (denominator). At the same time, it is adapted to the suitable data format.



Tip!

Make sure that the input signal is processed unscaled (100% correspond to 16384) when determining the values for C1093 and C1094.

For the decimal positions of the target code, always multiply the value to be transmitted with the factor 10000.

Mandatory:

$$\text{Value of the target code} = \left[\text{Input signal [\%]} \cdot \frac{16384}{100} \cdot \frac{C1093}{C1094} + C1095 \right] \cdot \frac{1}{10000}$$

Example 1

A signal of 100 % is to result in a maximum current I_{\max} (C0022) of 10 A.

- The input signal of 100 % results in an input value of 16384.
- The value to be transmitted (C1090) must be 100000 (10 A · 10000).
- Enter these values in C1093 (numerator) and C1094 (denominator):

$$\frac{C1093}{C1094} = \frac{\text{Value to be transmitted}}{\text{Input value}} = \frac{100000}{16384}$$

Example 2

A signal of 10 % ... 50 % is to result in an acceleration time T_{ir} (C0012) of 1.5 s ... 7.5 s.

- The input signal of 50 % results in an input value of 8192.
- The value to be transmitted (C1090) must be 75000 (7.5 s · 10000).
- Enter these values in C1093 (numerator) and C1094 (denominator):

$$\frac{C1093}{C1094} = \frac{\text{Value to be transmitted}}{\text{Input value}} = \frac{75000}{8192}$$

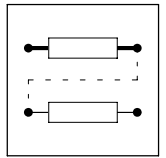

2.4.34 Programming of fixed setpoints (FIXSET)

This FB is used to change an analog signal source to programmed fixed values.

You can use these fixed values e.g. for different dancer setpoint positions in a dancer position control or different stretch ratios (gearbox factor) for a speed ratio synchronizing with digital frequency coupling.

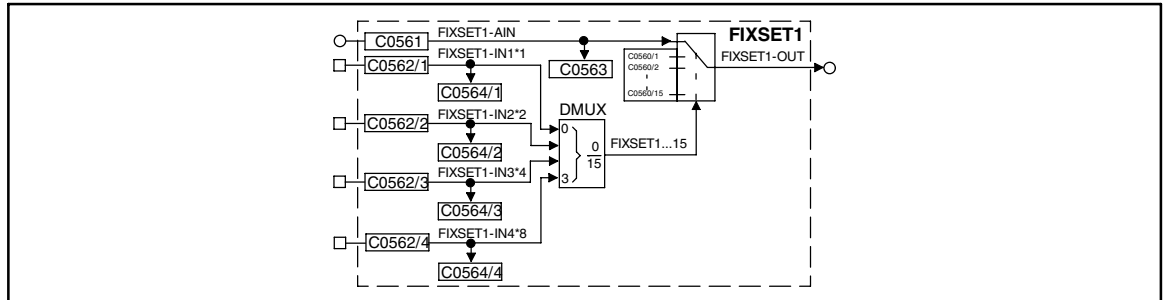

Fig. 2-84 Programming of fixed setpoints (FIXSET1)

Name	Signal			Source			Note
	Type	DIS	DIS format	CFG	List	Lenze	
FIXSET1-AIN	a	C0563	dec [%]	C0561	1	1000	The input is switched to the output, if a LOW level is applied at all selection inputs FIXSET-INx.
FIXSET1-IN1*1	d	C0564/1	bin	C0562/1	2	1000	The number of inputs to be assigned depends on the number of required FIXSET setpoints.
FIXSET1-IN2*2	d	C0564/2	bin	C0562/2	2	1000	
FIXSET1-IN3*4	d	C0564/3	bin	C0562/3	2	1000	
FIXSET1-IN4*8	d	C0564/4	bin	C0562/4	2	1000	
FIXSET1-OUT	a	-	-	-	-	-	

Function

The output of the FB can be used as a setpoint source (signal source) for another FB (e.g. process controller, arithmetic block, etc.). The parameterization and handling is the same as for the JOG setpoints in FB NSET. (2-136)

- Parameterization of the fixed setpoints
 - The individual fixed setpoints are parameterized by the subcodes of C0560.
- Output of the selected fixed setpoint:
 - If the binary inputs are triggered with a HIGH signal, a fixed setpoint from the table is switched to the output.
- Range:
 - The values for the fixed setpoint can be between -200 % and +200 %.

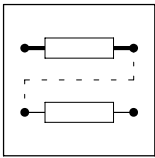

Configuration

Function blocks

2.4.34.1 Enable of the FIXSET1 setpoints

Number of required fixed setpoints	Number of the inputs to be assigned
1	at least 1
1 ... 3	at least 2
4 ... 7	at least 3
8 ... 15	4

Decoding table of the binary input signals:

Output signal FIXSET1-OUT =	1st input FIXSET1-IN1	2nd input FIXSET1-IN2	3rd input FIXSET1-IN3	4th input FIXSET1-IN4
FIXSET1-AIN	0	0	0	0
C0560/1	1	0	0	0
C0560/2	0	1	0	0
C0560/3	1	1	0	0
C0560/4	0	0	1	0
C0560/5	1	0	1	0
C0560/6	0	1	1	0
C0560/7	1	1	1	0
C0560/8	0	0	0	1
C0560/9	1	0	0	1
C0560/10	0	1	0	1
C0560/11	1	1	0	1
C0560/12	0	0	1	1
C0560/13	1	0	1	1
C0560/14	0	1	1	1
C0560/15	1	1	1	1

0 = LOW

1 = HIGH

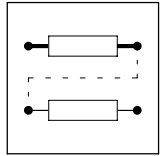

2.4.35 Flipflop (FLIP)

These FBs are D-flipflops. This function is used to evaluate and save digital signals.

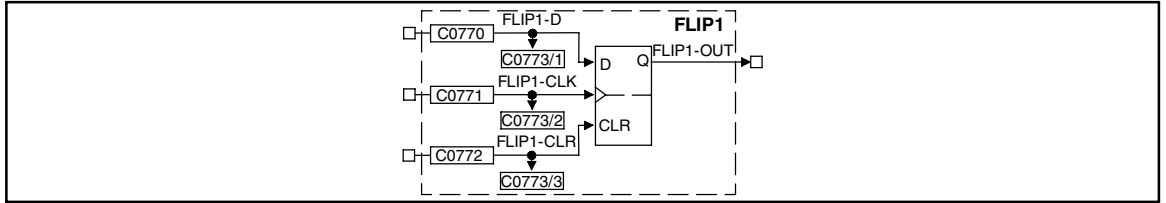

Fig. 2-85

Flipflop (FLIP1)

Name	Signal			Source			Note
	Type	DIS	DIS format	CFG	List	Lenze	
FLIP1-D	d	C0773/1	bin	C0770	2	1000	-
FLIP1-CLK	d	C0773/2	bin	C0771	2	1000	Evaluates LOW-HIGH edges only
FLIP1-CLR	d	C0773/3	bin	C0772	2	1000	Evaluates the input level only: input has highest priority
FLIP1-OUT	d	-	-	-	-	-	-

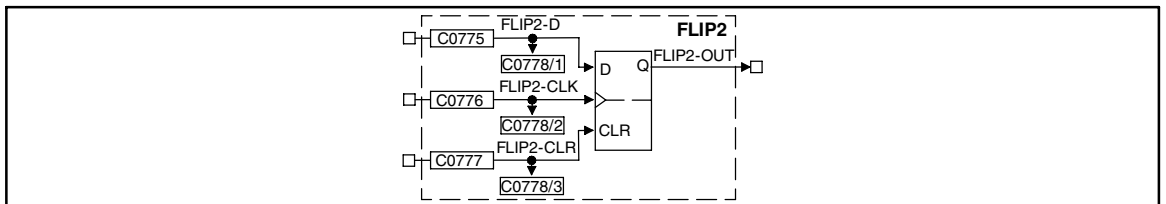
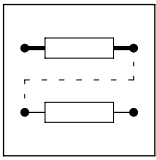

Fig. 2-86

Flipflop (FLIP2)

Name	Signal			Source			Note
	Type	DIS	DIS format	CFG	List	Lenze	
FLIP2-D	d	C0778/1	bin	C0775	2	1000	-
FLIP2-CLK	d	C0778/2	bin	C0776	2	1000	Evaluates LOW-HIGH edges only
FLIP2-CLR	d	C0778/3	bin	C0777	2	1000	Evaluates the input level only: input has highest priority
FLIP2-OUT	d	-	-	-	-	-	-



Configuration

Function blocks

Function

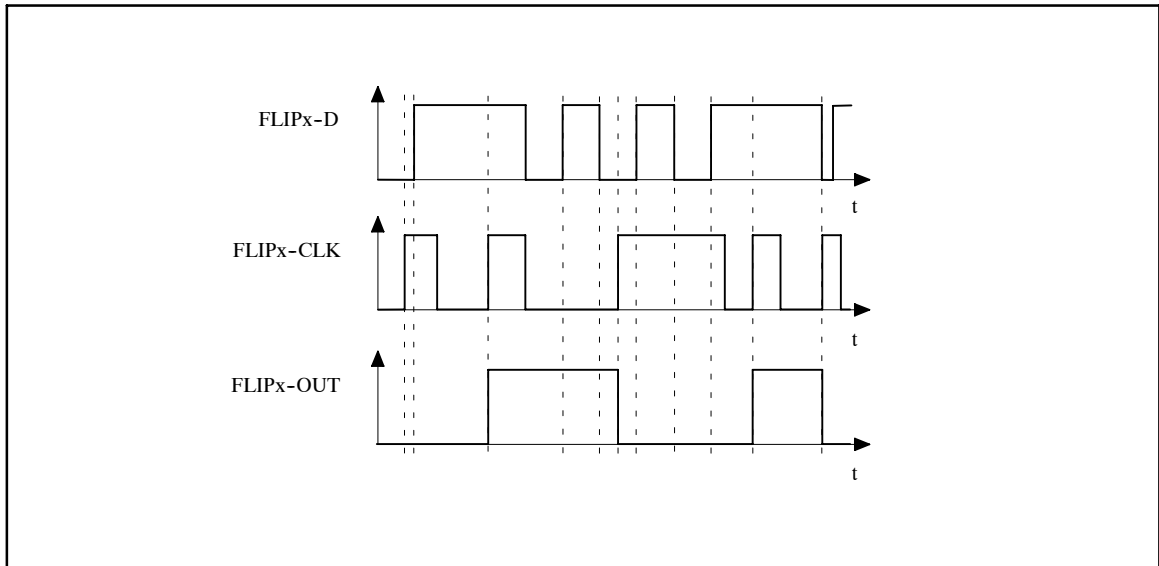
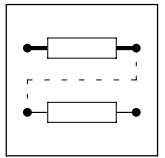

Fig. 2-87

Sequence of a flipflop

- A LOW-HIGH signal at the input FLIPx-CLK changes the signal at the input FLIPx-D to the output FLIPx-OUT and saves it until
 - another LOW-HIGH edge is applied at the input FLIPx-CLK or
 - the input FLIPx-CLR is set HIGH.
- The input FLIPx-CLR always has priority.
 - If the input FLIPx-CLR = HIGH, the output FLIPx-OUT = LOW and held as long as FLIPx-CLR = HIGH.



2.4.36 Curve follower (FOLL)

This FB is used to evaluate slowly changing process variables and use them for drive control.

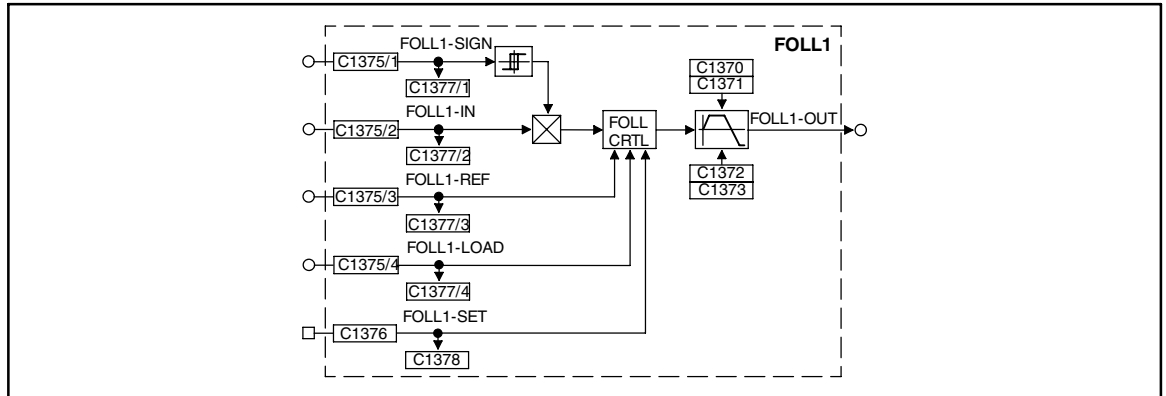

Fig. 2-88

Curve follower (FOLL1)

Name	Signal			Source			Note
	Type	DIS	DIS format	CFG	List	Lenze	
FOLL1-SIGN	a	C1377/1	dec [%]	C1375/1	1	1000	-
FOLL1-IN	a	C1377/2	dec [%]	C1375/2	1	1000	-
FOLL1-REF	a	C1377/3	dec [%]	C1375/3	1	1000	-
FOLL1-LOAD	a	C1377/4	dec [%]	C1375/4	1	1000	-
FOLL1-SET	d	C1378	bin	C1376	2	1000	-
FOLL1-OUT	a	-	-	-	-	-	-

Function

- Basic function
- Setting the initial value
- Saving the initial value

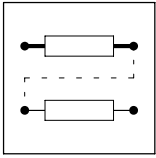

Configuration

Function blocks

2.4.36.1 Basic function

- If the input signal at FOLL1-IN exceeds the reference value at FOLL1-REF, the ramp function generator starts and the output signal at FOLL1-OUT has the same direction as the input signal.
- You can change the sign of the input signal at FOLL1-IN with a negative signal at the input FOLL1-SIGN.
 - If the input signal at FOLL1-IN exceeds the reference value at FOLL1-REF, the ramp function generator starts and the output signal at FOLL1-OUT has the opposite direction as the input signal.

Setting range of the ramp generator

- C1370 defines the upper limit $FOLL_{max}$ in [%]
- C1371 defines the lower limit $FOLL_{min}$ in [%]

Acceleration and deceleration time of the ramp function generator

- C1372 defines the acceleration time $FOLL_{Tir}$ in [s]
- C1373 defines the deceleration time $FOLL_{Tif}$ in [s]

2.4.36.2 Setting the initial value

An initial value is set via the inputs

- FOLL1-SET (analog signal) or
- FOLL1-LOAD (digital signal).

2.4.36.3 Saving the initial value

- The reached output value is saved when the controller is switched off.
 - The value saved last is loaded when the controller is switched on.

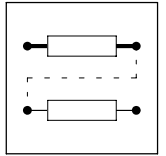

2.4.37 Integrator (INT)

These FBs calculate an angle of rotation from a speed signal. The angle of rotation is output as phase signal and analog signal.

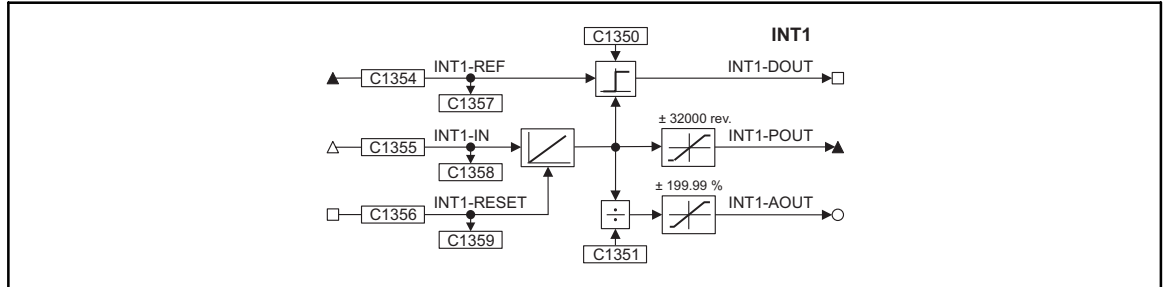

Fig. 2-89 Integrator (INT1)

Name	Signal			Source			Note
	Type	DIS	DIS format	CFG	List	Lenze	
INT1-REF	ph	C1357	dec [inc]	C1354	3	1000	-
INT1-IN	phd	C1358	dec [rpm]	C1355	4	1000	-
INT1-RESET	d	C1359	bin	C1356	2	1000	HIGH = sets the integrator to zero
INT1-DOUT	d	-	-	-	-	-	-
INT1-POUT	ph	-	-	-	-	-	-
INT1-AOUT	a	-	-	-	-	-	limited to $\pm 199.99\%$

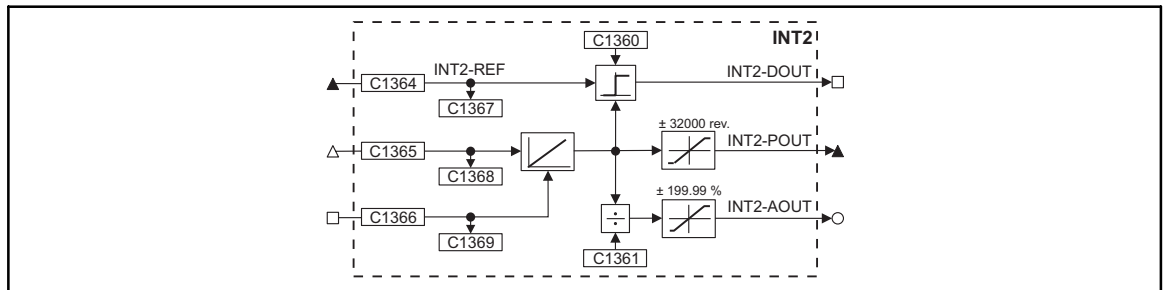
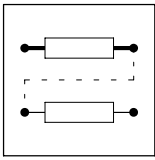

Fig. 2-90 Integrator (INT2)

Name	Signal			Source			Note
	Type	DIS	DIS format	CFG	List	Lenze	
INT2-REF	ph	C1367	dec [inc]	C1364	3	1000	-
INT2-IN	phd	C1368	dec [rpm]	C1365	4	1000	-
INT2-RESET	d	C1369	bin	C1366	2	1000	HIGH = sets the integrator to zero
INT2-DOUT	d	-	-	-	-	-	-
INT2-POUT	ph	-	-	-	-	-	-
INT2-AOUT	a	-	-	-	-	-	limited to $\pm 199.99\%$

Range of functions

- Output angle of rotation as phase signal
- Compare angle of rotation with reference value
- Output angle of rotation as analog signal
- Phase signal reset



Configuration

Function blocks

2.4.37.1 Output angle of rotation as phase signal

The speed signal at INTx-IN is integrated to an angle of rotation. After this, the angle of rotation is output as a phase signal at INTx-POUT.

An angle of rotation of 360 ° (one revolution) corresponds to 65536 increments (inc).

2.4.37.2 Compare angle of rotation with reference value

The angle of rotation obtained at INTx-IN can be compared with a reference value.

An angle of rotation of 360 ° (one revolution) corresponds to 65536 increments (inc).

- Apply a phase signal as reference value to INTx-REF.
- If the angle of rotation (integrated speed signal at INTx-IN) reaches the reference value at INTx-REF, INTx-DOUT changes to HIGH.
- The following comparison operations are available:

Function block	Code	Value	Function
INT1	C1350	0	INT1-DOUT = HIGH, if angle of rotation ≥ reference value
		1	INT1-DOUT = HIGH, if angle of rotation ≥ reference value
INT2	C1360	0	INT2-DOUT = HIGH, if angle of rotation ≥ reference value
		1	INT2-DOUT = HIGH, if angle of rotation ≥ reference value

2.4.37.3 Output angle of rotation as analog signal

The speed signal at INTx-IN is integrated to an angle of rotation. The angle of rotation is normalised under C1351 (INT1) and C1361 (INT2) and converted into an analog signal. After this, it is output as an analog signal at INTx-POUT.

The following formula is used for the conversion (in this case for INT1):

$$\text{INT1-AOUT} = \frac{\text{Drehwinkel [inc]}}{\text{C1351}} \cdot 100 \%$$

An angle of rotation of 360 ° (one revolution) corresponds to 65536 increments (inc).

Example

The angle of rotation for 100 revolutions shall correspond to an analog signal of 100 %.

Solution:

- 100 revolutions correspond to an angle of rotation of 100 · 65536 inc = 6553600 inc.
- Enter this value under C1351.

2.4.37.4 Phase signal reset

INTx-RESET = HIGH resets the calculated angle of rotation to zero.

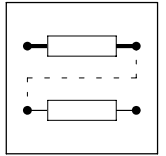

2.4.38 Limitation (LIM)

This FB limits the input signal to an adjustable range.

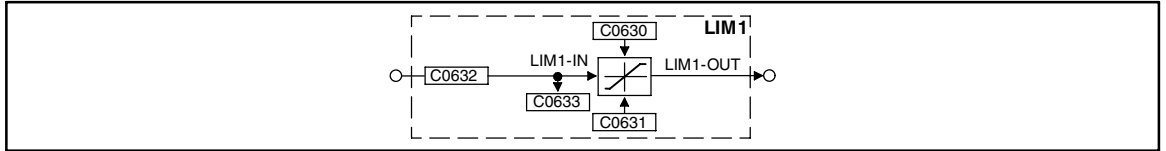

Fig. 2-91

Limitation (LIM1)

Name	Signal			Source			Note
	Type	DIS	DIS format	CFG	List	Lenze	
LIM1-IN1	a	C0633	dec [%]	C0632	1	1000	-
LIM1-OUT	a	-	-	-	-	-	-

Function

- If the input signal exceeds the upper limit (C0630), the upper limit is effective.
- If the input signal falls below the lower limit (C0631), the lower limit is effective.



Tip!

The lower limit (C0631) must be smaller than the upper limit (C0630).

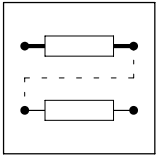

Configuration

Function blocks

2.4.39 Internal motor control with V/f characteristic control (MCTRL1)

For the function block description, please see the corresponding System Manual:

- EVF9321 ... EVF9333 controllers
 - System Manual with document number EDSVF9333V
- EVF9335 ... EVF9338 and EVF9381 ... EVF9383 controllers
 - System Manual with document number EDSVF9383V

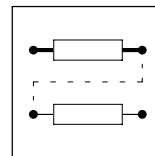

2.4.40 Internal motor control with vector control (MCTRL2)

For the function block description, please see the corresponding System Manual:

- EVF9321 ... EVF9333 controllers
 - System Manual with document number EDSVF9333V
- EVF9335 ... EVF9338 and EVF9381 ... EVF9383 controllers
 - System Manual with document number EDSVF9383V

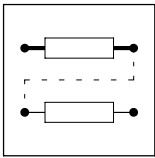

Configuration

Function blocks

2.4.41 Mains failure control (MFAIL)

This FB is used to decelerate the drive/drive network in a controlled manner to standstill. Without this function, the drive/drive network would coast down after a mains failure.



Tip!

The basic configurations speed control with mains failure control (C0005 = 14xx) and digital frequency master with mains failure control (C0005 = 54xx) are application examples which can be directly loaded.

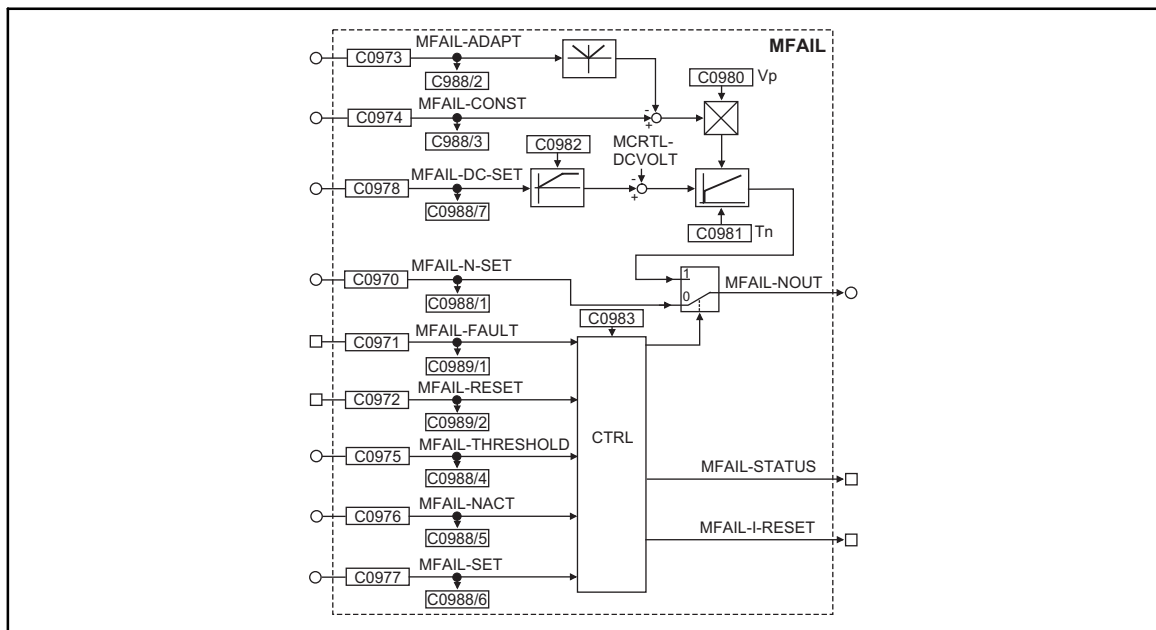
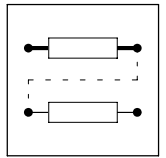

Fig. 2-92 Mains failure control (MFAIL)

Name	Signal			Source			Note
	Type	DIS	DIS format	CFG	List	Lenze	
MFAIL-N-SET	a	C0988/1	dec [%]	C0970	1	1000	Speed setpoint in [%] of C0011
MFAIL-ADAPT	a	C0988/2	dec [%]	C0973	1	1000	Dynamic adaptation of the proportional gain of the U_{Gset} controller in [%] of C0980
MFAIL-KONST	a	C0988/3	dec [%]	C0974	1	1000	Proportional gain of the U_{Gset} controller in [%] of C0980
MFAIL-THRESHOLD	a	C0988/4	dec [%]	C0975	1	1000	Restart threshold in [%] of C0011
MFAIL-NACT	a	C0988/5	dec [%]	C0976	1	1000	Comparison value for the restart threshold in [%] of C0011
MFAIL-SET	a	C0988/6	dec [%]	C0977	1	1000	Speed starting point for deceleration in [%] of C0011
MFAIL-DC-SET	a	C0988/7	dec [%]	C0978	1	1000	Voltage setpoint at which the DC-bus voltage is to be maintained, 100 % = 1000 V
MFAIL-FAULT	d	C0989/1	bin	C0971	2	1000	HIGH = activates the mains failure control
MFAIL-RESET	d	C0989/2	bin	C0972	2	1000	HIGH = reset
MFAIL-N-OUT	a	-	-	-	-	-	Speed setpoint in [%] of C0011
MFAIL-STATUS	d	-	-	-	-	-	HIGH = mains failure control is active
MFAIL-I-RESET	d	-	-	-	-	-	HIGH = mains failure control is active, the drive is braking



Range of functions

- Mains failure detection
- Mains failure control
- Restart protection
- Reset of the mains failure control
- Dynamic adaptation of the control parameters
- Fast mains recovery (KU)
- Application examples

2.4.41.1 Mains failure detection

The type of the mains-failure detection to be used depends on the drive system used.

A failure of the voltage supply of the power stage is detected:

- by the level of the DC-bus voltage or
- by an external system (e.g. supply module or voltage-detection relay).
- Different systems can be combined.

Mains failure detected by the level of the DC-bus voltage

Use with single drives or multi-axis drives, which do not use external monitoring systems.

- For this, you can use a comparator (e.g. CMP2). Set the following signal links:
 - C0688/1 = 5005 (MCTRL-DCVOLT to CMP2-IN1)
 - C0688/2 = 19540 (free code C0472/20 to CMP2-IN2)
 - C0971 = 10655 (CMP2-OUT to MFAIL-FAULT)
 - Set the comparator function CMP2 with C0685 = 3

Enter the function blocks CMP2 and MFAIL at free positions into the processing table under C0465.

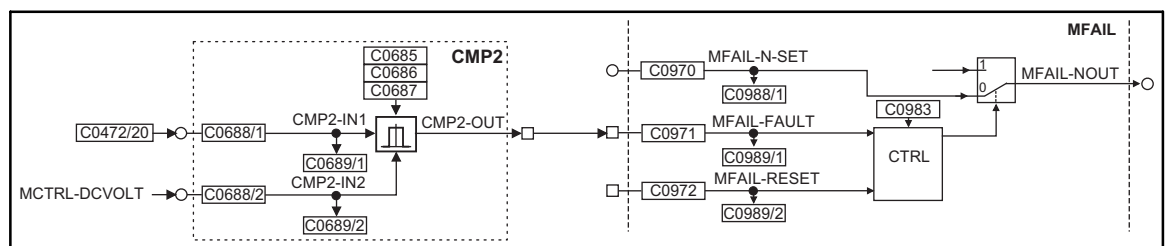
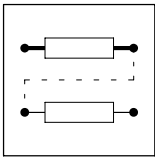

Fig. 2-93

Example of a mains failure detection with internal function blocks (section)



Configuration

Function blocks

Mains failure detection of the supply module

- A digital output of the supply module is switched to the function block MFAIL via the digital inputs DIGIN of the 93XX controller. In the example, input X5/E4 is used. Set the following signal links:
 - C0971 = 54 (DIGIN4 to MFAIL-FAULT)
 - C0871 = 1000 (remove DCTRL-TRIP-SET from terminal X5/E4)
 - Select the input level (HIGH or LOW active) with C0114/4

Enter the FB MFAIL at a free position into the processing table under C0465.

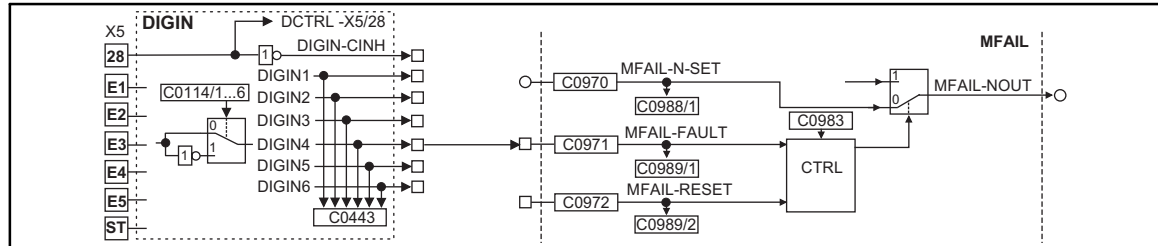

Fig. 2-94

Example of a mains failure detection by an external monitoring system

Combination of these methods

- These methods are combined via an OR link with an internal function block. In the example, OR5 is used. Set the following signal links:
 - C0688/1 = 5005 (MCTRL-DCVOLT to CMP2-IN1)
 - C0688/2 = 19540 (free code C0472/20 to CMP2-IN2)
 - Set the comparator function CMP2 with C0685 = 3
 - C0838/1 = 10655 (CMP2-OUT to OR5-IN1)
 - C0838/2 = 54 (DIGIN5 to OR5-IN2)
 - C0971 = 10570 (OR5-OUT to MFAIL-FAULT)

Enter the function blocks CMP2, OR5 and MFAIL at free positions into the processing table under C0465.

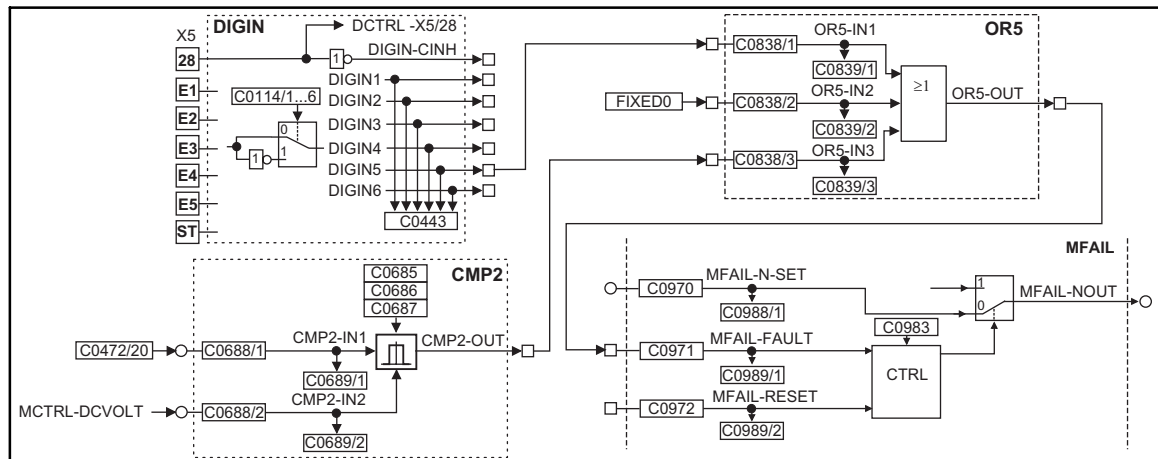
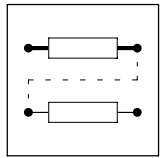

Fig. 2-95

Example of a mains failure detected by different sources



2.4.41.2 Mains failure control

Integration of the FB into the signal flow of the controller

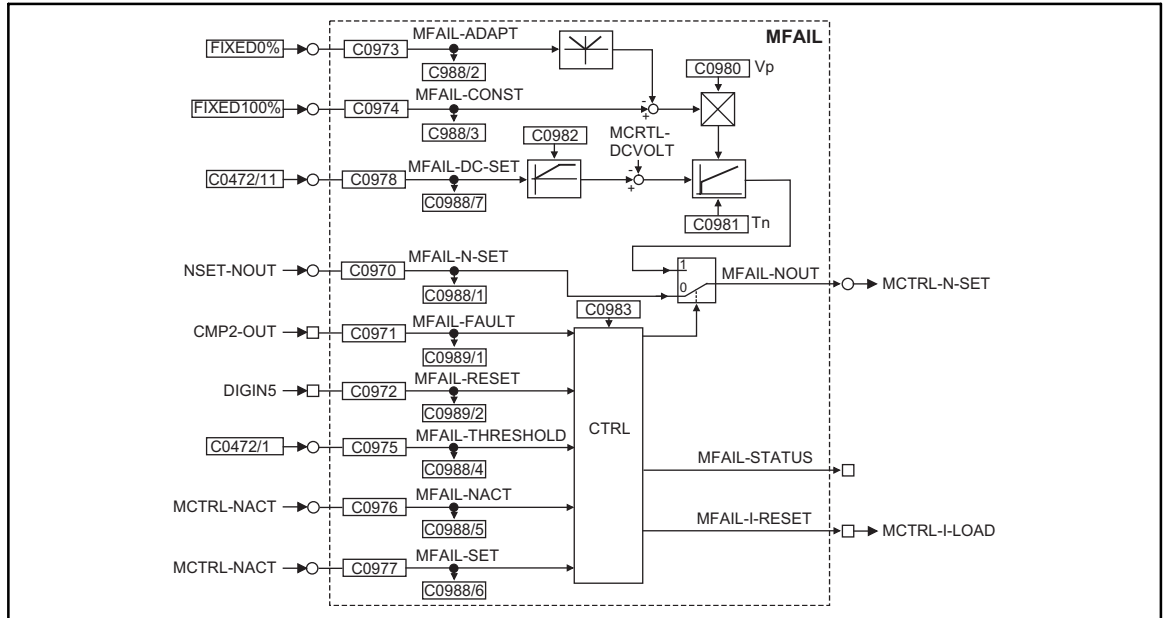
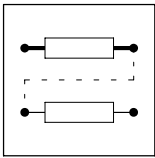

Fig. 2-96

Links for the basic configuration C0005 = 1000

As an example, the function block is integrated into the basic configuration C0005 = 1000 (speed control):

1. Create the speed setpoint path:
 - C0970 = 5050 (NSET-NOUT to MFAIL-N-SET)
 - C0890 = 6100 (MFAIL-NOUT to MCTRL-N-SET)
2. Define the start value for deceleration (here, the actual speed value):
 - C0977 = 6100 (MFAIL-NOUT to MFAIL-SET)
3. Define the source for the setpoint of the DC-bus voltage (here, from the freely linkable code FCODE C0472/19):
 - C0978 = 19539 (C0472/19 to MFAIL-DC-SET)
4. Define the source for the activation of the mains failure control. (2-117):



Configuration

Function blocks

5. Proportional gain and adaptation of the DC-bus voltage controller:
 - C0974 = 1006 (FIXED100% to MFAIL-CONST)
 - C0973 = 1000 (FIXED0% to MFAIL-ADAPT)
6. Establish the restart protection
 - C0976 = 6100 (MFAIL-NOUT to MCTRL-NACT)
 - C0975 = 19538 (C0472/18 to MFAIL-THRESHOLD)
 - Under C0472/18, first, enter approx. 2 % (reference: n_{\max} C0011)
7. Connect the reset input (here, with terminal X5/E5 TRIP-RESET):
 - C0972 = 55 (DIGIN5 to MFAIL-RESET)
8. Enter all functions blocks which are used (except for codes and digital inputs DIGIN) at free positions into the processing table under C0465.



Tip!

Use C0003 to save all settings in a parameter set , if they are to be retained on power-off.

Activation

- MFAIL-FAULT = HIGH activates the mains failure control.
- MFAIL-FAULT = LOW triggers a timing element. After elapse of the preset time under C0983, the mains failure control is ended/cancelled. (☞ 2-127, mains recovery)
 - The drive is accelerated to the speed setpoint, if the restart protection is not active.
 - The drive is still braked to zero speed, if the restart protection is active. (☞ 2-126, restart protection)
 - When restart protection is active, the drive can only be reset with MFAIL-RESET = HIGH.

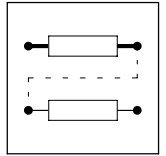

Function

The drive controller gains the required energy from the rotational energy of the driven machine. The driven machine is braked through the power loss of the controller and the motor. The speed deceleration ramp is thus shorter than for an uncontrolled system (coasting drive).

After activation:

- The DC-bus voltage is controlled to the value at the input MFAIL-DC-SET.
- At the output MFAIL-N-OUT, an internally generated speed setpoint is output. The drive can thus be braked to zero speed (via the speed setpoint).
 - The start value for the controlled deceleration is the value at the input MFAIL-SET. This input is usually connected to the output MCTRL-NACT (actual speed) or MCTRL-NSET2, MFAIL-NOUT (set speed).
 - The speed deceleration ramp (and thus the brake torque) results from the moment of inertia of the driven machine(s), the power loss of the drive (group), and the parameter settings.



Stop!

- If a connected brake unit is activated, the drive is braked with the maximum possible torque (I_{max}). In this case, it may be necessary to adapt the parameterisation (see description of parameter setting).
- If the power stage is not supplied, the drive cannot generate a standstill torque (important for active loads such as hoists).

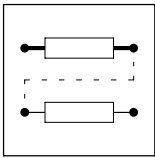

Configuration

Function blocks

Parameter setting

The parameters to be set are strongly dependent on the motor used, the inertia of the driven machine and the drive configuration (single drive, drive network, master-slave operation, etc.). This function must therefore be adapted to the individual application in every case.

The following specifications refer to the description of the mains failure detection. (☞ 2-117)

Important settings prior to the initial commissioning:

1. Save the settings in a parameter set (e.g. parameter set 4).



Stop!

With internal voltage supply to the terminals (C0005 = xx1x), terminal X6/63 is used as a voltage source for external potentiometers. In this case, measure across terminals +U_G, -U_G.

2. Measure the DC-bus voltage with an oscilloscope (channel 1):
 - With a suitable voltage divider across the terminals +U_G, -U_G or
 - by providing the DC-bus voltage at terminal X6/62, for instance. To do this, set C0436 = 5005 (MCTRL-DCVOLT). 1 V at terminal X6/62 corresponds to 100 V at +U_G, -U_G.
3. Measure the speed with an oscilloscope (channel 2):
 - By providing the speed at terminal X6/62, for instance, (standard setting). To do this, set C0431 = 5001 (MCTRL-NACT). 10 V at terminal X6/62 correspond to n_{\max} (C0011).

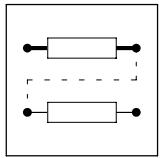

4. Select the threshold for the mains failure detection under C0472/20. The selection depends on the setting under C0173.
 - Set the threshold approx. 50 V above the switch-off threshold LU (example for C0173 = 0.1; C0472/20 = 33.5 % = 335 V).

9300 vector	UG thresholds						
EVF9321 ... EVF9333	Mains voltage range		C0173	Switch-off threshold LU	Switch-on threshold LU	Switch-off threshold OU	Switch-on threshold OU
	< 400 V	Operation with/without brake chopper	0	285 V	430 V	770 V	755 V
	400 V	Operation with/without brake chopper	1 *	285 V	430 V	770 V	755 V
	460 V	Operation with/without brake chopper	2	328 V	473 V	770 V	755 V
	480 V	Operation without brake chopper	3	342 V	487 V	770 V	755 V
	480 V	Operation with brake chopper	4	342 V	487 V	800 V	785 V

9300 vector	UG thresholds						
EVF9335 ... EVF9383	Mains voltage range		C0173	Switch-off threshold LU	Switch-on threshold LU	Switch-off threshold OU	Switch-on threshold OU
EVF93xx-ExV210 EVF93xx-ExV240 EVF93xx-ExV270 EVF93xx-ExV300	< 400 V	Operation with or without brake transistor	0	285 V	430 V	770 V	755 V
	400 V	Operation with or without brake transistor	1 *	285 V	430 V	770 V	755 V
	460 V	Operation with or without brake transistor	2	328 V	473 V	770 V	755 V
	480 V	Operation without brake transistor	3	342 V	487 V	770 V	755 V
	480 V	Operation with brake transistor	4	342 V	487 V	800 V	785 V
	500 V	Operation with or without brake transistor	5	342 V	487 V	900 V	885 V
EVF93xx-Ex EVF93xx-ExV060 EVF93xx-ExV110	400 V	Operation with or without brake transistor	Only display	285 V	430 V	700 V	685 V

* Lenze setting



Stop!

This setpoint must be below the threshold of any brake unit which may be connected. If a connected brake unit is activated, the drive is braked with the maximum possible torque (I_{max}). The desired operating behaviour is lost.

5. Set the setpoint to which the DC-bus voltage is to be controlled:
 - Set the setpoint to approx. 700 V (C0472/18 = 70 %).

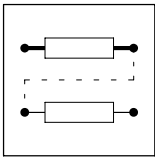

Configuration

Function blocks

Commissioning

The commissioning should be carried out with motors without any load.

1. Start the drive with a LOW-HIGH transition at X5/E5.
2. Setting the acceleration time T_{ir} :
 - Set the speed setpoint to 100 %, operate the controller with maximum speed.
 - Inhibit the controller via terminal X5/28 (you can also use any other source for the controller inhibit, CINH) and measure the deceleration time to standstill.
 - Set approx. 1/10 of the deceleration time under C0982.
3. Setting the retrigger time
 - For mains failure detection by detecting the DC-bus voltage level:
 - Under C0983, set the deceleration time measured under point 2..
 - For mains failure detection via an external system (e.g. 934X supply module):
 - Under C0983, set the time for which the drive continues to be braked in a controlled way in the event of a short-term mains recovery.
4. Switch off the supply voltage (mains or DC bus).
 - The oscilloscope should display the following sequence:

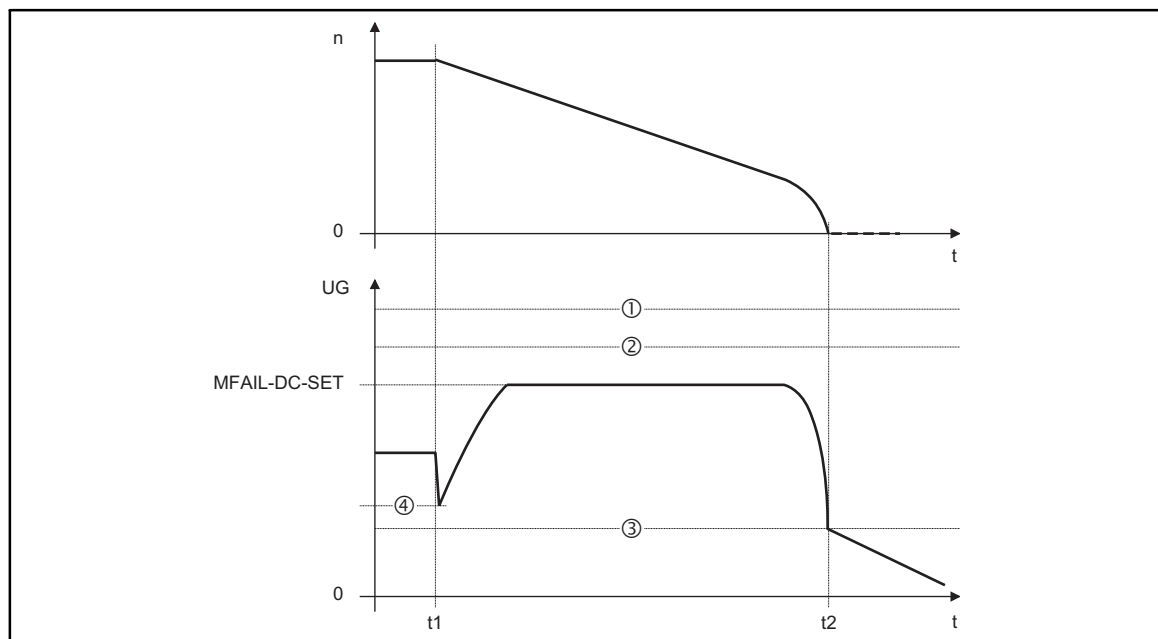
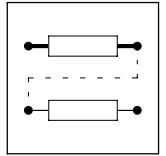

Fig. 2-97

Schematic representation with activated mains failure control (ideal characteristic)

- ① Switch-off threshold OU
- ② Switch-on threshold for brake unit
- ③ Switch-off threshold LU
- ④ Threshold CMP2-OUT
- t1 Mains failure
- t2 Zero speed reached



Fine setting

For the fine setting, repeat the following points several times.

1. Try to obtain a very low final speed without the controller reaching the undervoltage threshold LU:
 - Increase the proportional gain V_p (C0980).
 - Reduce the integral-action time T_n (C0981).
2. Try to avoid activation of the brake unit or the undervoltage threshold OU:
 - Increase the integral-action time T_n (C0981) until the characteristic in Fig. 2-97 is almost reached.
 - If necessary, also reduce the setpoint of the DC-bus voltage at the input MFAIL-DC-SET (in the example C0472/19).
3. An increase of the deceleration time or reduction of the brake torque (see Fig. 2-98) is only possible with restrictions:
 - Increasing the acceleration time T_{ir} (C0982) reduces the initial brake torque and simultaneously increases the deceleration time.
 - Increasing the integral-action time T_n (C0981) reduces the initial brake torque and simultaneously increases the deceleration time. If the integral-action times under C0981 are too long, the controller reaches the LU threshold before zero speed is reached. The drive is thus no longer under control.
4. Re-establish any signal connections which may be required to the outputs of the drive controller (terminals X6).



Tip!

Use C0003 to save all settings in a parameter set , if they are to be retained on power-off.

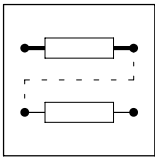

Configuration

Function blocks

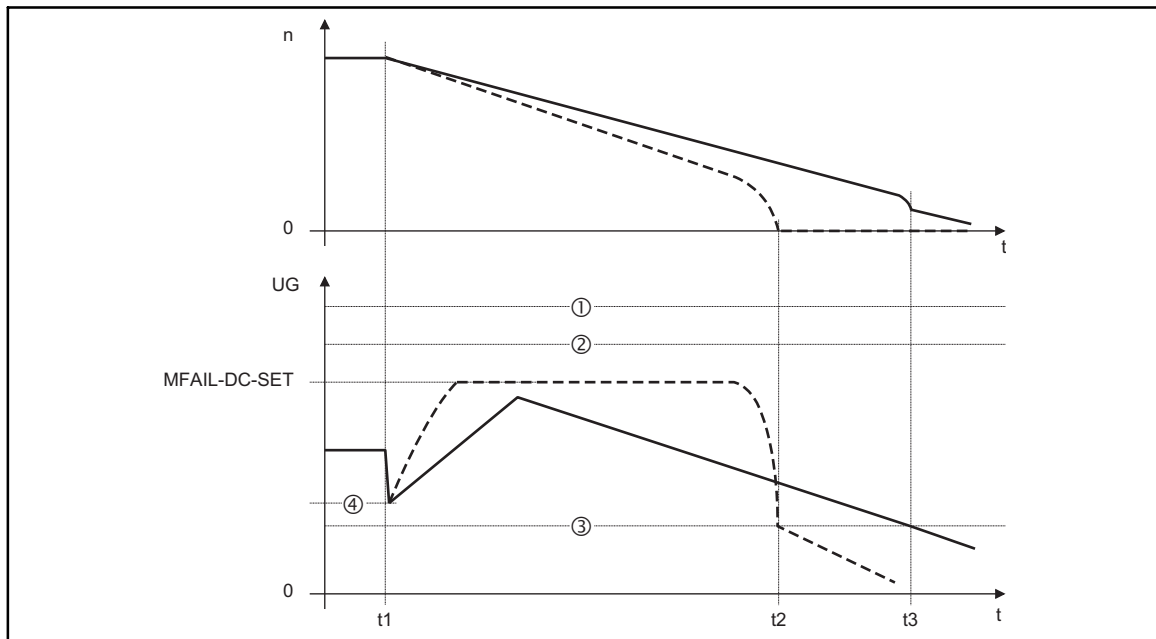

Fig. 2-98

Schematic representation with different brake torques

- ① Switch-off threshold OU
- ② Switch-on threshold for brake unit
- ③ Switch-off threshold LU
- ④ Threshold CMP2-OUT

t = t1 Mains failure

t = t2 Zero speed with higher brake torque (short adjustment time)

t = t3 Drive reaches the LU switch-off threshold with lower brake torque (high adjustment time), without reaching zero speed

t > t3 Drive is no longer under control (is braked by friction)

2.4.41.3 Restart protection

The integrated restart protection is to avoid a restart in the lower speed range, after the supply voltage was interrupted for a short time only (mains recovery before the drive has come to standstill).

- Establish the restart protection. (2-119, point 6.)
- In C0472/18, enter the threshold in [%] of n_{max} (C0011) below which no automatic start is wanted after mains recovery.
 - If the speed at mains recovery < threshold in C0472/18, the drive will still be braked under control. This function can only be ended by MFAIL-RESET = HIGH.
 - If the speed at mains recovery > threshold in C0472/18, the drive accelerates to its setpoint along the set ramps.
- This function is deactivated by:
 - C0472/18 = 0 % or
 - C0975 = 1000 (FIXED0% to MFAIL-THRESHLD)
- A reset is made by MFAIL-RESET = HIGH:
 - A reset is required after every mains (re)connection
 - The reset is shown by MFAIL-STATUS = HIGH, when MFAIL-FAULT = LOW.

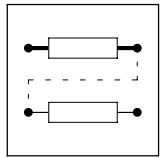

2.4.41.4 Reset of the mains failure control

- The mains failure control is reset with MFAIL-RESET = HIGH (in the example, through terminal X5/E5).
- The reset pulse is always required if:
 - The restart protection is active.
 - The restart protection is used and the supply (mains or DC supply) was switched on.

2.4.41.5 Dynamic adaptation of the control parameters

In special cases, a dynamic modification of the proportional gain may be useful. Two inputs (MFAIL-CONST and MFAIL-ADAPT) are available for this purpose at the FB MFAIL. The resulting proportional gain results from:

$$V_p = C0980 \cdot \frac{MFAIL-CONST - |MFAIL-ADAPT|}{100 \%}$$

2.4.41.6 Fast mains recovery (KU)

The fast mains recovery causes a restart of the controller, unless the restart protection is active. The drive accelerates to its setpoint. If this is not wanted, you can delay the restart by the retrigger time C0983 or prevent it in combination with the restart protection.

A fast mains recovery occurs:

- Due to the system, the mains recovery is indicated by the mains failure detection via the level of the DC-bus voltage. (▣ 2-117)
- Because of a "short interruption" (KU) of the utility company (e.g. in a thunderstorm).
- Because of faulty components in the supply cables (e.g. slip-rings).

So set the retrigger time C0983 > the measured deceleration time achieved in braking operation.

2.4.41.7 Application example

Drive network with digital frequency coupling



Stop!

For drive networks which are connected via digital frequency (a master and one or more slaves):

- The mains failure detection and control must only be activated for the master.
 - You must link the mains failure control into the signal flow to meet this requirement.
- You must operate all the controllers through the terminals +UG, -UG in a DC-bus configuration. Observe the specifications in the chapter "Dimensioning".

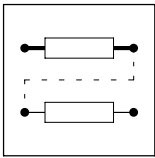

Configuration

Function blocks

2.4.42 Motor phase failure detection (MLP)

Purpose

Motor phase monitoring.

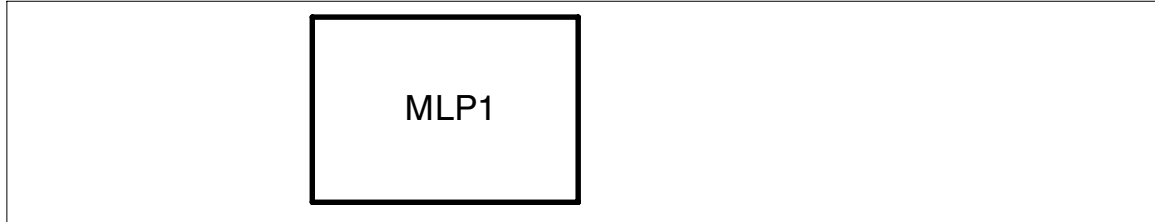

Fig. 2-99

Motor phase failure detection (MLP1)

Code	LCD	Possible settings			IMPORTANT	
		Lenze	Selection			
C0597	MONIT LP1	3	0	Trip	Conf. LP1 Configuration of motor phase failure monitoring	
			2	Warning		
			3	Off		
C0599	LIMIT LP 1	5.0	1.0	{0.1}	10.0	Current limit LP1 Current limit for motor phase failure monitoring

Function

For detailed descriptions of the monitorings / error messages, please see the chapter "Troubleshooting and fault elimination" in the System Manual.

The function block MLP1 must be entered into the processing table, if the motor phase failure detection shall be used.

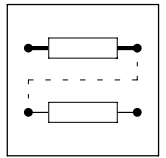

2.4.43 Monitor outputs of monitoring system (MONIT)

Purpose

The monitoring functions output digital monitor signals.

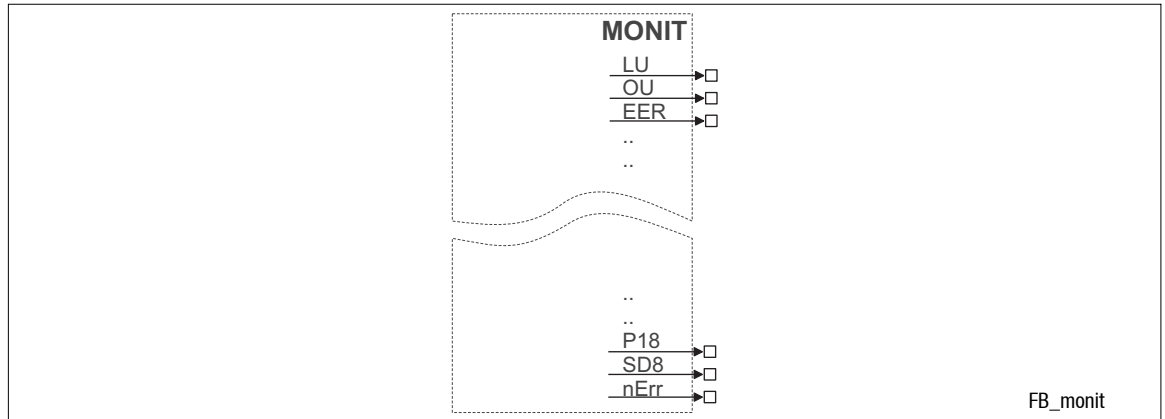

Fig. 2-100 Monitor outputs of the monitoring system (MONIT)

Function

The MONIT-outputs switch to HIGH level if one of the monitoring functions responds.

The digital monitor signals respond dynamically, i.e.

- depending on the state of the monitoring function, but
- independent of the selected fault reaction.

Example

MONIT-LP1 (motor phase monitoring) responds if a cable disruption is detected in a motor connection phase, although the fault reaction of LP1 is set to "Off" (C0597 = 3).



Tip!

- Only with a corresponding signal conditioning it is possible to use the MONIT-outputs to detect the cause of malfunction afterwards (e.g. storing the signal by using function block FLIP).
- A detailed description concerning monitoring /fault messages can be found in the chapter "Troubleshooting and fault elimination".

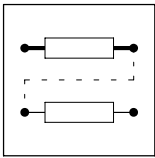

Configuration

Function blocks

2.4.44 Motor potentiometer (MPOT)

This FB is used as an alternative setpoint source which is triggered by two inputs.

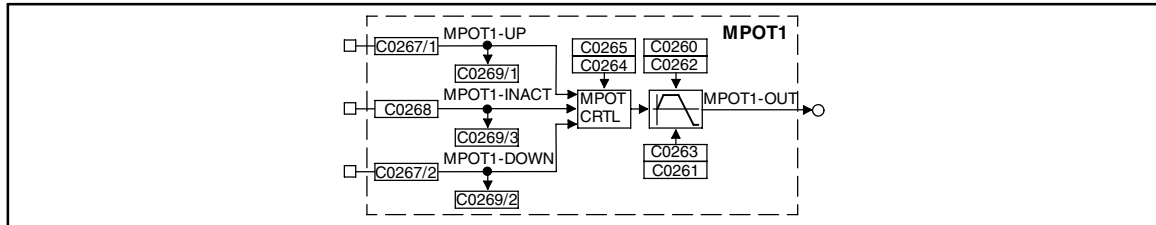

Fig. 2-101 Motor potentiometer (MPOT1)

Name	Signal			Source			Note
	Type	DIS	DIS format	CFG	List	Lenze	
MPOT1-UP	d	C0269/1	bin	C0267/1	2	1000	-
MPOT1-INACT	d	C0269/3	bin	C0268	2	1000	-
MPOT1-DOWN	d	C0269/2	bin	C0267/2	2	1000	-
MPOT1-OUT	a	-	-	-	-	-	-

Range of functions

- Control of the motor potentiometer
- Deactivation of the motor potentiometer
- Initialization of the motor potentiometer

2.4.44.1 Control of the motor potentiometer

- MPOT1-UP = HIGH
– The motor potentiometer approaches its upper limit.
- MPOT1-DOWN = HIGH
– The motor potentiometer approaches its lower limit.
- MPOT1-UP = LOW and MPOT1-DOWN = LOW or
MPOT1-UP = HIGH and MPOT1-DOWN = HIGH:
– The motor potentiometer does not change its output signal.

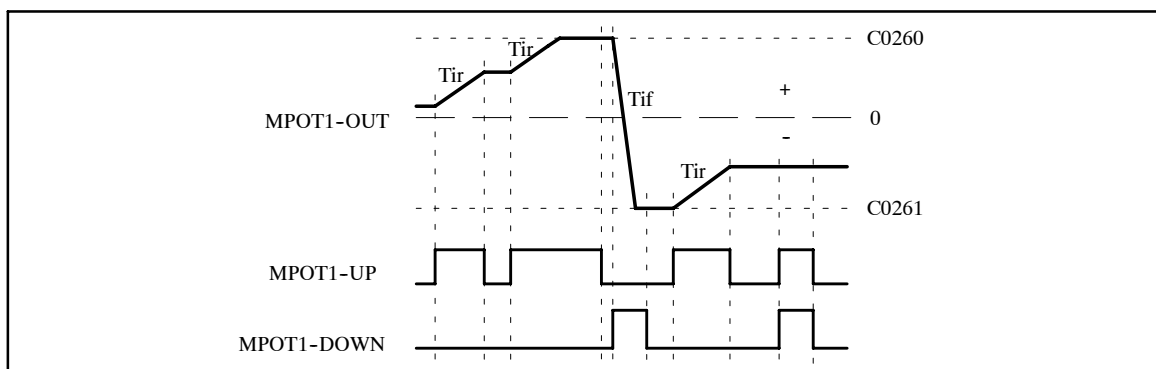
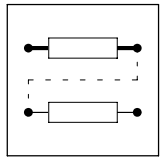

Fig. 2-102 Control signals of the motor potentiometer



2.4.44.2 Deactivation of the motor potentiometer

You can deactivate the function of the motor potentiometer using the input MPOT1-INACT.

- The motor potentiometer function is deactivated with MPOT1-INACT = HIGH.
- The input MPOT1-INACT has priority over the inputs MPOT1-UP and MPOT1-DOWN.
- When the function is deactivated, the output signal at MPOT1-OUT follows the function set under C0264. You can set the following functions under C0264:

C0264	Meaning
0	No further action; the output MPOT1-OUT keeps its value
1	The motor potentiometer returns to 0 % with the corresponding T_i time
2	The motor potentiometer approaches its lower limit (C0261) with the corresponding deceleration time
3	The motor potentiometer immediately changes its output to 0% (important for emergency stop function)
4	The motor potentiometer immediately changes its output to the lower limit (C02619
5	The motor potentiometer approaches its upper limit (C0260) with the corresponding T_i time

If the deactivation of the motor potentiometer is cancelled with MPOT1-INACT = LOW, the subsequent function depends on

- the momentary output signal,
- the set limits (C0261: lower limit, C0260: upper limit),
- the control signals MPOT1-UP and MPOT1-DOWN.

If the output value is out of the limits, the output signal approaches the next limit with the suitable T_i time (C0262: acceleration time T_{ir} , C0263: deceleration time T_{if}). This function is independent of the control inputs MPOT1-UP and MPOT1-DOWN

If the output value is within the limits, the output signal follows the selected control function MPOT1-UP, MPOT1-DOWN or no action.

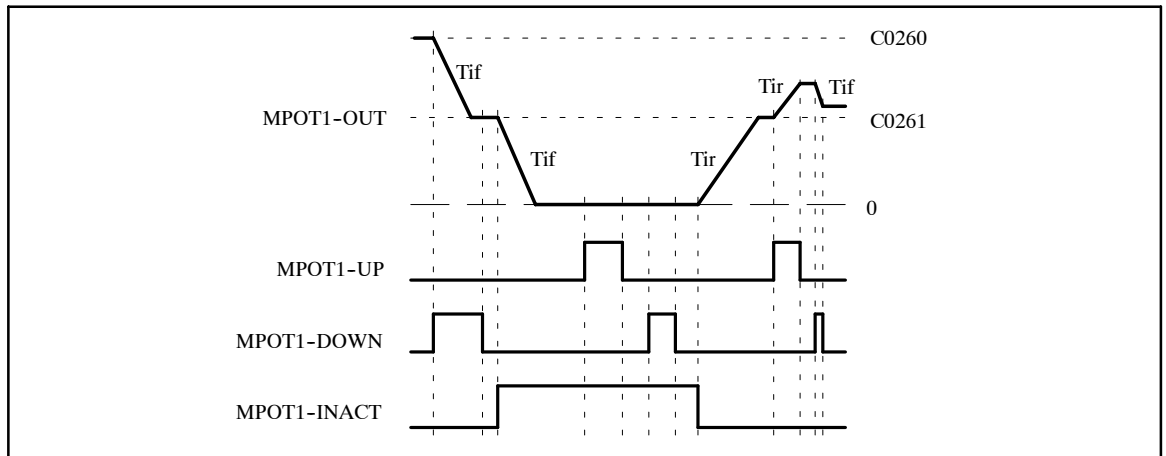
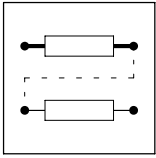

Fig. 2-103 Deactivation of the motor pot via the input MPOT1-INACT



Configuration

Function blocks

2.4.44.3 Initialization of the motor potentiometer

Under C0265, you can activate different initialization functions for the mains switch-on.

- C0265 = 0
 - The current output value is saved before mains disconnection or mains failure. The motor potentiometer starts with this value after mains connection.
- C0265 = 1
 - The motor potentiometer starts with the lower limit (C0261) after mains connection.
- C0265 = 2
 - The motor potentiometer starts with 0% after mains connection.

If the initialization is completed, the motor potentiometer follows the applied control function.

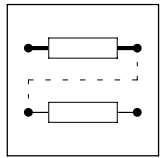

2.4.45 Blocking frequencies (NLIM)

This FB blocks signals in max. three speed ranges which can be defined. The output signal skips the defined ranges. If you use the output signal as setpoint speed, the motor only passes the blocked ranges.

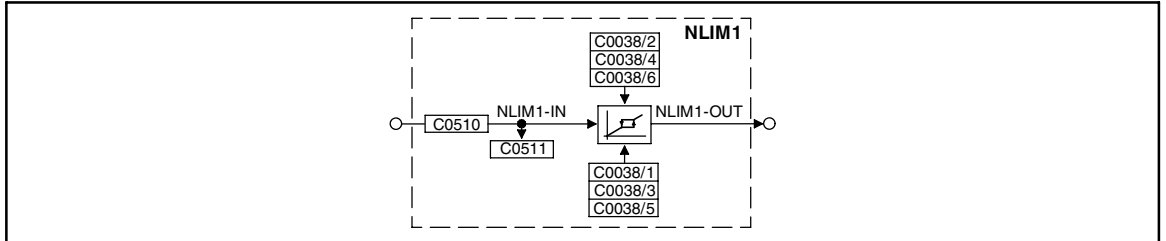

Fig. 2-104

Blocking frequencies (NLIM1)

Name	Signal			Source			Note
	Type	DIS	DIS format	CFG	List	Lenze	
NLIM1-IN	a	C0511	dec [%]	C0510	1	1000	-
NLIM1-OUT	a	-	-	-	-	-	-

Function

A blocked speed range is activated by entering a lower and an upper speed limit.

The output signal remains at the lower limit of the block range until the input signal has over- or undershot the blocked speed range.

Code	Choice	Function
C0038/1	0 {1 rpm} 36000 0 = Function not active	Blocked speed range 1
C0038/2		
C0038/3		Blocked speed range 2
C0038/4		
C0038/5		Blocked speed range 3
C0038/6		

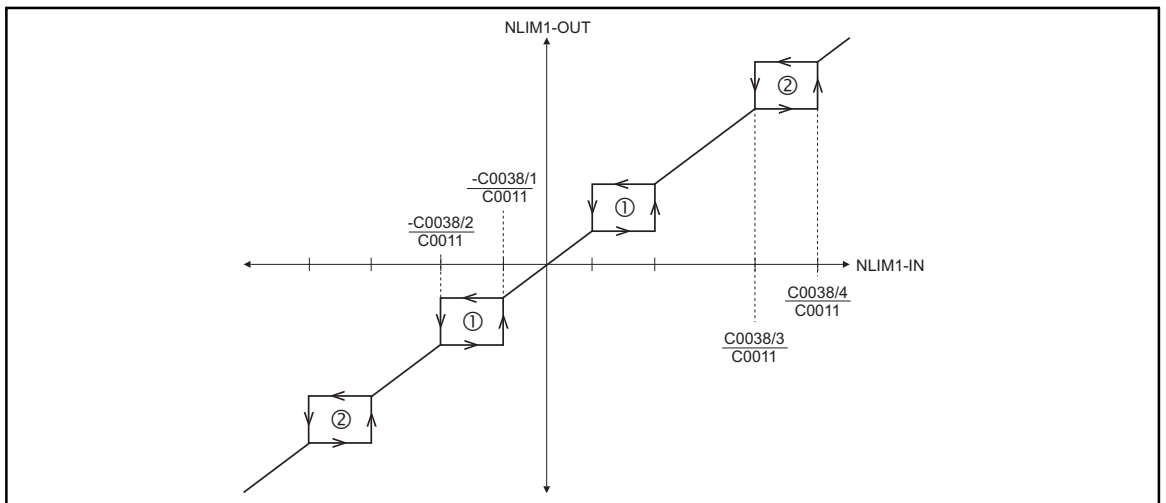
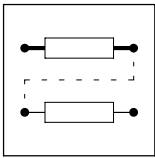

Fig. 2-105

Representation of the upper and lower limits of the blocked speed ranges

- ① Blocked speed range 1
- ② Blocked speed range 2



Configuration

Function blocks

2.4.46 Logic NOT

These FB enable a long inversion of digital signals. You can use the FBs for the control of functions or the generation of status information.

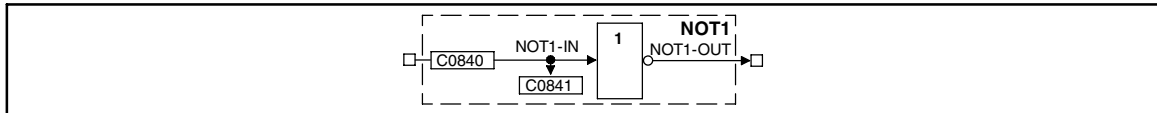

Fig. 2-106 Logic NOT

Name	Signal			Source			Note
	Type	DIS	DIS format	CFG	List	Lenze	
NOT1-IN	d	C0841	bin	C0840	2	1000	-
NOT1-OUT	d	-	-	-	-	-	-

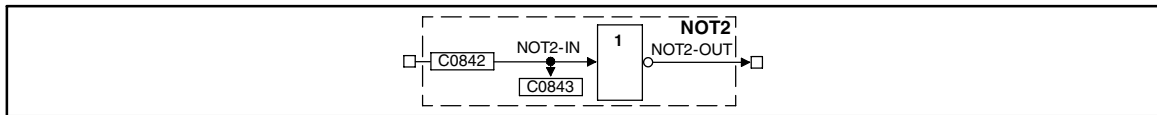

Fig. 2-107 Logic NOT (NOT2)

Name	Signal			Source			Note
	Type	DIS	DIS format	CFG	List	Lenze	
NOT2-IN	d	C0843	bin	C0842	2	1000	-
NOT2-OUT	d	-	-	-	-	-	-

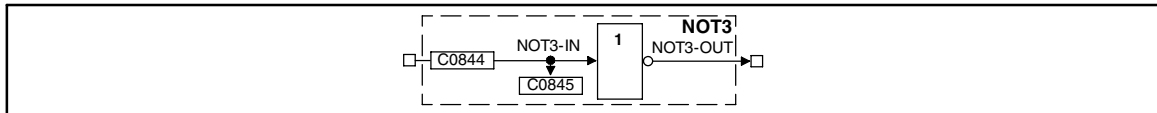

Fig. 2-108 Logic NOT (NOT3)

Name	Signal			Source			Note
	Type	DIS	DIS format	CFG	List	Lenze	
NOT3-IN	d	C0845	bin	C0844	2	1000	-
NOT3-OUT	d	-	-	-	-	-	-

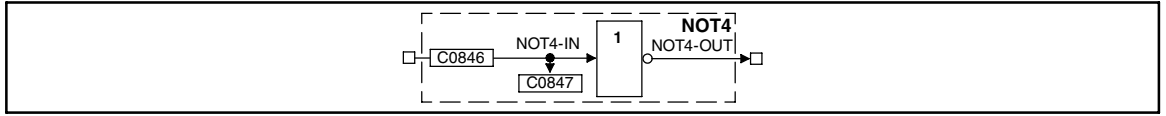
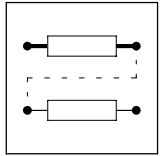

Fig. 2-109 Logic NOT (NOT4)

Name	Signal			Source			Note
	Type	DIS	DIS format	CFG	List	Lenze	
NOT4-IN	d	C0847	bin	C0846	2	1000	-
NOT4-OUT	d	-	-	-	-	-	-

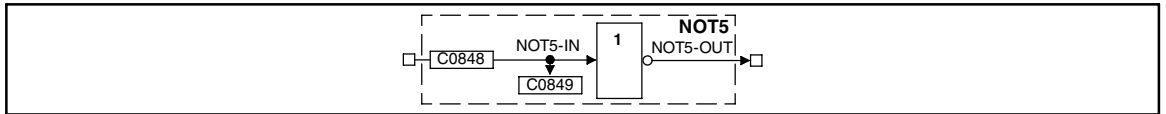

Fig. 2-110 Logic NOT (NOT5)

Name	Signal			Source			Note
	Type	DIS	DIS format	CFG	List	Lenze	
NOT5-IN	d	C0849	bin	C0848	2	1000	-
NOT5-OUT	d	-	-	-	-	-	-

Function

NOTx-IN1	NOTx-OUT
0	1
1	0

0 = LOW

1 = HIGH

In a contactor control, the function corresponds to a change from a normally-open to a normally-closed contact.

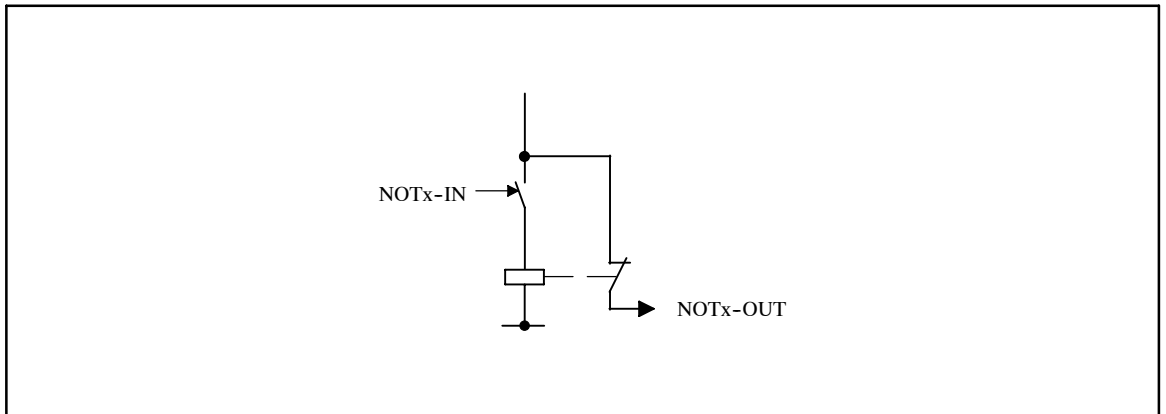
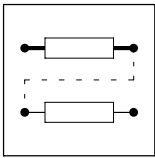

Fig. 2-111 Function of NOT as a change from a normally-open to a normally-closed contact



Configuration

Function blocks

2.4.47 Speed preconditioning (NSET)

This FB contains several functions that can be used to generate a speed setpoint. Both analog and digital input signals are conditioned.

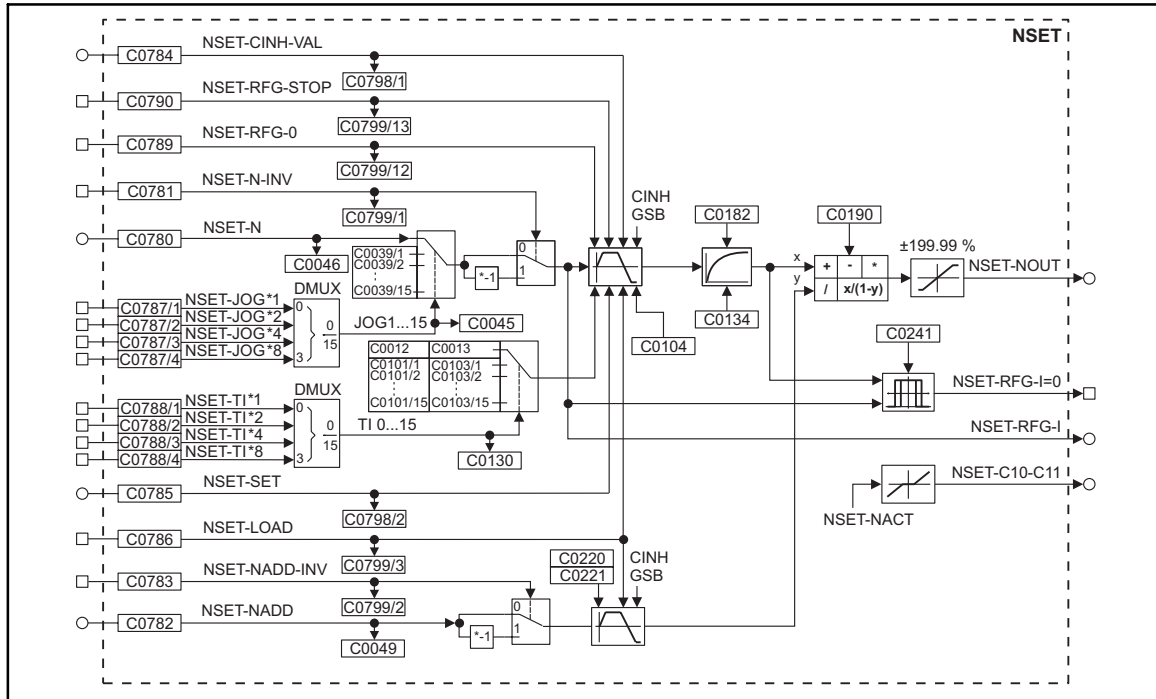
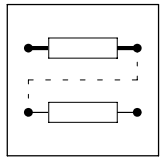

Fig. 2-112 Speed setpoint preconditioning (NSET)



Name	Signal			Source			Note
	Type	DIS	DIS format	CFG	List	Lenze	
NSET-N	a	C0046	dec [%]	C0780	1	50	Provided for main setpoint; other signals are permissible
NSET-NADD	a	C0047	dec [%]	C0782	1	5650	Provided for additional setpoint; other signals are permissible
NSET-JOG*1	d	C0799/4	bin	C0787/1	2	53	Selection and control of overriding "fixed setpoints" for the main setpoint
NSET-JOG*2	d	C0799/5	bin	C0787/2	2	1000	
NSET-JOG*4	d	C0799/6	bin	C0787/3	2	1000	
NSET-JOG*8	d	C0799/7	bin	C0787/4	2	1000	
NSET-TI*1	d	C0799/8	bin	C0788/1	2	1000	Selection and control of alternative "fixed setpoints" for the main setpoint
NSET-TI*2	d	C0799/9	bin	C0788/2	2	1000	
NSET-TI*4	d	C0799/10	bin	C0788/3	2	1000	
NSET-TI*8	d	C0799/11	bin	C0788/4	2	1000	
NSET-N-INV	d	C0799/1	bin	C0781	2	10251	Control of the signal inversion for the main setpoint
NSET-NADD-INV	d	C0799/2	bin	C0783	2	1000	Control of the signal inversion for the additional setpoint
NSET-RFG-0	d	C0799/12	bin	C0789	2	1000	Leads the main setpoint integrator via the current T_i times to 0
NSET-RFG-STOP	d	C0799/13	bin	C0790	2	1000	Holding (freezing) of the main setpoint integrator to its current value
NSET-CINH-VAL	a	C0798/1	dec [%]	C0784	1	5001	Here the signal is applied that the main setpoint integrator is to accept when the controller is inhibited
NSET-SET	a	C0798/2	dec [%]	C0785	1	5000	Here the signal is applied that the main setpoint integrator is to accept when the input NSET-LOAD is set
NSET-LOAD	d	C0799/3	bin	C0786	2	5001	Control of both ramp function generators in special situations, e.g. QSP
NSET-OUT	a	-	-	-	-	-	Limited to $\pm 199.99\%$
NSET-RFG-I=0	d	-	-	-	-	-	-
NSET-RFG-I	a	-	-	-	-	-	-
NSET-C10-C11	a	-	-	-	-	-	-

Range of functions

- Main setpoint channel
- JOG setpoints
- Setpoint inversion
- Ramp function generator for the main setpoint
- Acceleration functions
- S-ramp
- Arithmetic operation
- Additional setpoint

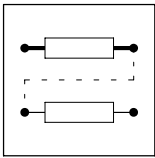

Configuration

Function blocks

2.4.47.1 Main setpoint channel

- The signal at the input NSET-N is initially led by the function JOG-select.
- The JOG function overrides the setpoint input NSET-N. I.e. a selected JOG value switches the input inactive. After this, the following signal conditioning uses the JOG value.
- The signals in the main setpoint channel are limited to the range of $\pm 199.99\%$.

2.4.47.2 JOG setpoints

The JOG setpoints are parameterised under C0039/1 ... C0039/15.

- JOG setpoints are fixed values that are defined under C0039/1 ... C0039/15.
- The JOG values can be activated via the inputs NSET-JOG*x.
- The four inputs NSET-JOG*x are binary coded, so that 15 JOG values can be called.
- The decoding for the enabling of the JOG values is carried out according to the following table:

Output signal	1st input NSET-JOG*1	2nd input NSET-JOG*2	3rd input NSET-JOG*4	4th input NSET-JOG*8
NSET-n	0	0	0	0
JOG 1	1	0	0	0
JOG 2	0	1	0	0
JOG 3	1	1	0	0
JOG 4	0	0	1	0
JOG 5	1	0	1	0
JOG 6	0	1	1	0
JOG 7	1	1	1	0
JOG 8	0	0	0	1
JOG 9	1	0	0	1
JOG 10	0	1	0	1
JOG 11	1	1	0	1
JOG 12	0	0	1	1
JOG 13	1	0	1	1
JOG 14	0	1	1	1
JOG 15	1	1	1	1

0 = LOW

1 = HIGH

- If all inputs are set to 0, the input NSET-N is active.
- The number of inputs to be assigned depends on the number of JOG setpoints required. A maximum of 4 inputs and thus 15 selection possibilities are available. Digital signal sources are assigned under C0787 and the corresponding subcode.

Number of the required JOG setpoints	Number of the inputs to be assigned
1	at least 1
1 ... 3	at least 2
4 ... 7	at least 3
8 ... 15	4

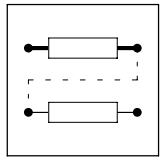

2.4.47.3 Setpoint inversion

The output signal of the JOG function is led via an inverter.

The sign of the setpoint is inverted, when the input NSET-N-INV = HIGH.

2.4.47.4 Ramp function generator for the main setpoint

The setpoint is then led via a ramp function generator with a linear characteristic. The ramp function generator converts setpoint jumps at the input into a ramp.

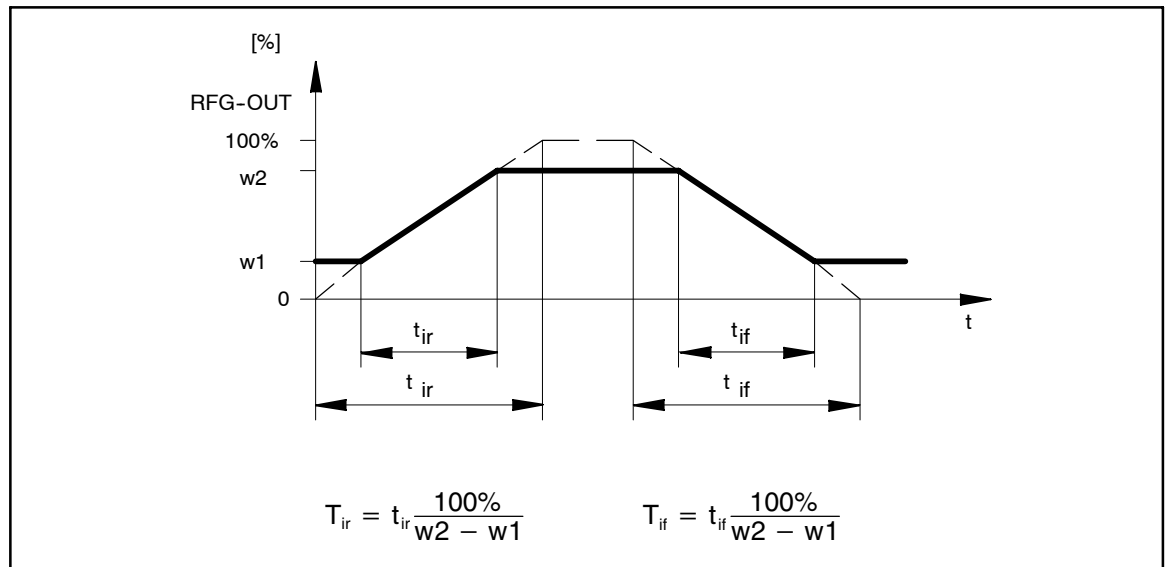
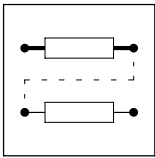

Fig. 2-113

Acceleration and deceleration times of the ramp function generator

- The acceleration and deceleration ramps can be separately selected.
 - Via the inputs NSET-TI*x 16 you can activate different acceleration and deceleration times (see JOG setpoints, table and function. The decoding is made according to the signal plan).
 - The T_i times can only be activated in pairs.
- When the controller inhibit (CINH) is set, the ramp function generator accepts the value at the input NSET-CINH-VAL and passes it on to the following function. This function has priority over all other functions.
- NSET-RFG-STOP = HIGH
 - The ramp function generator is stopped. Changes at the input of the ramp function generator have no effect on the output signal.
- NSET-RFG-0 = HIGH
 - The ramp function generator decelerates to zero along its deceleration ramp.
- It is also possible to load the ramp function generator in advance with a value. For this, the input NSET-LOAD must be set = HIGH. As long as this input is set, the value at the input NSET-SET is accepted by the ramp function generator and provided at the output.



Configuration

Function blocks

Priorities:

CINH	NSET-LOAD	NSET-RFG-0	NSET-RFG-STOP	Function
0	0	0	0	RFG follows the input value via the set ramps
0	0	0	1	The value at the output of RFG is frozen
0	0	1	0	RFG decelerates to zero along the set deceleration ramp
0	0	1	1	
0	1	0	0	RFG accepts the value at the input NSET-SET and provides it at its output
0	1	0	1	
0	1	1	0	
0	1	1	1	RFG accepts the value at the input NSET-CINH-VAL and provides it at its output
1	0	0	0	
1	0	0	1	
1	0	1	0	
1	0	1	1	
1	1	0	0	
1	1	0	1	
1	1	1	0	
1	1	1	1	

0 = LOW

1 = HIGH

2.4.47.5 Acceleration functions

Under C0104, you can select the following acceleration functions for the linear ramp function generator:

Code	Function	Application
C0104 = 0	The drive starts and stops with constant acceleration. The actual acceleration time is proportional to the selected setpoint and the activated T_i time. The following formula applies: $t_{acc} = T_i \cdot \frac{n_{soll}}{n_{max}}$	
C0104 = 1	The drive starts and stops in the activated T_i time. The selected setpoint has no influence on the acceleration time. The following formula applies: $t_{acc} = T_i$	With acceleration with a fixed time, a drive system is, for instance, simultaneously accelerated and decelerated to standstill. The individual drives can have different speed values.
C0104 = 2	The drive starts and stops with a predefined number of revolutions or over a selected distance. The actual acceleration time results from the selected setpoint and the activated T_i time. The following formula applies: $t_{acc} = T_i \cdot \frac{n_{max}}{n_{soll}}$	With acceleration over a specified distance, the distance selected via the T_i time is traversed when the drive is decelerated to standstill. The speed does not have any influence.

Start and stop with a preselected time or distance is only possible with the control signal at NSET-RFG-0 **and** after controller enable.

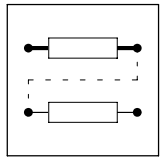

2.4.47.6 S-ramp

A PT1 element is connected to the linear ramp function generator. This arrangement implements an S-ramp for an almost jerk-free acceleration and deceleration.

- The PT1 element is switched on/off under C0134.
- The time constant is set under C0182.

2.4.47.7 Arithmetic operation

The output value is led to an arithmetic function which combines the main setpoint and the additional setpoint. The arithmetic combination is selected under C0190 (see the following table).

C0190	Function	Example
0	Output = X (Y is not processed)	-
1	Output = X + Y	100 % = 50 % + 50 %
2	Output = X - Y	50 % = 100 % - 50 %
3	Output = X * Y	100 % = 100 % * 100 %
4	Output = X/ Y	1 % = 100 % / 100 %
5	Output = X/(100% - Y)	200 % = 100 % / (100 % - 50 %)

2.4.47.8 Additional setpoint

- Via the input NSET-NADD you can combine an additional setpoint (e.g. a correction signal) with the main setpoint.
- With NSET-NADD-INV = HIGH you can invert the signal at NSET-ADD, before it is applied to the ramp function generator. The ramp function generator has a linear characteristic with acceleration time T_{ir} (C0220) and deceleration time T_{if} (C0221).
- With NSET-LOAD = HIGH or when controller inhibit is set, the ramp function generator is set to 0 and held there, without considering the T_i times.

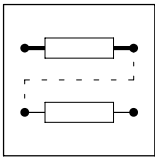

Configuration

Function blocks

2.4.48 Logic OR

These FBs enable a logic OP operation of digital signals. You can use the FBs for the control of functions or the generation of status information.

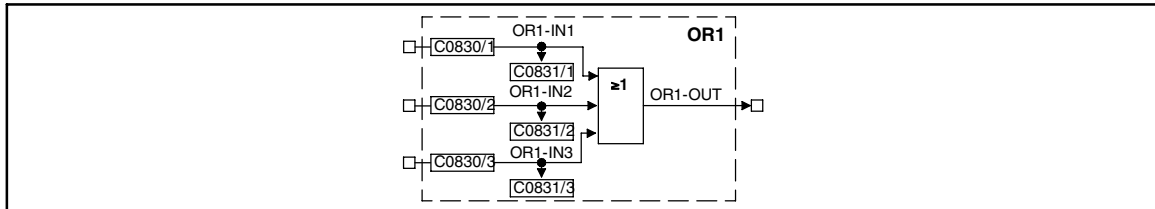

Fig. 2-114 Logic OR (OR1)

Name	Signal			Source			Note
	Type	DIS	DIS format	CFG	List	Lenze	
OR1-IN1	d	C0831/1	bin	C0830/1	2	1000	-
OR1-IN2	d	C0831/2	bin	C0830/2	2	1000	-
OR1-IN3	d	C0831/3	bin	C0830/3	2	1000	-
OR1-OUT	d	-	-	-	-	-	-

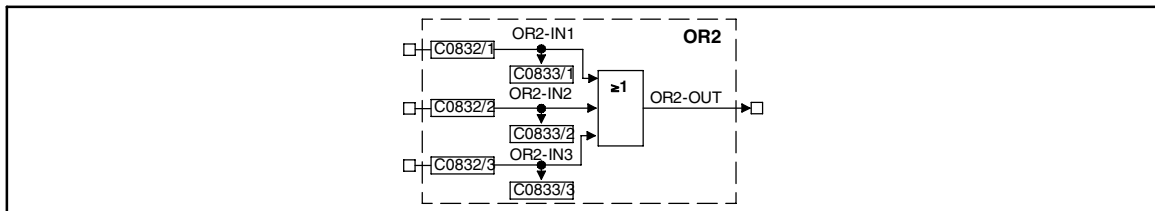

Fig. 2-115 Logic OR (OR2)

Name	Signal			Source			Note
	Type	DIS	DIS format	CFG	List	Lenze	
OR2-IN1	d	C0833/1	bin	C0832/1	2	1000	-
OR2-IN2	d	C0833/2	bin	C0832/2	2	1000	-
OR2-IN	d	C0833/3	bin	C0832/3	2	1000	-
OR2-OUT	d	-	-	-	-	-	-

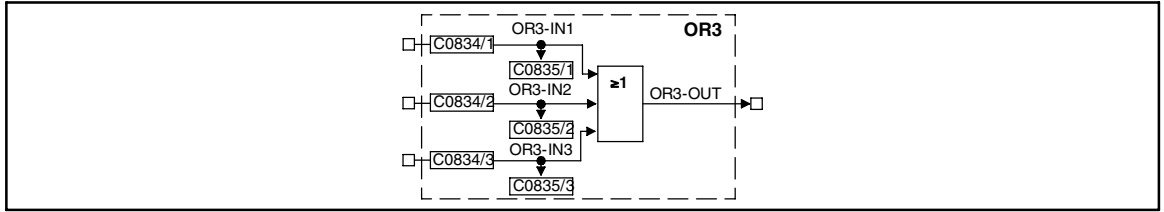
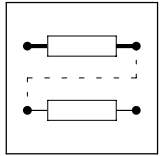

Fig. 2-116 Logic OR (OR3)

Name	Signal			Source			Note
	Type	DIS	DIS format	CFG	List	Lenze	
OR3-IN1	d	C0835/1	bin	C0834/1	2	1000	-
OR3-IN2	d	C0835/2	bin	C0834/2	2	1000	-
OR3-IN3	d	C0835/3	bin	C0834/3	2	1000	-
OR3-OUT	d	-	-	-	-	-	-

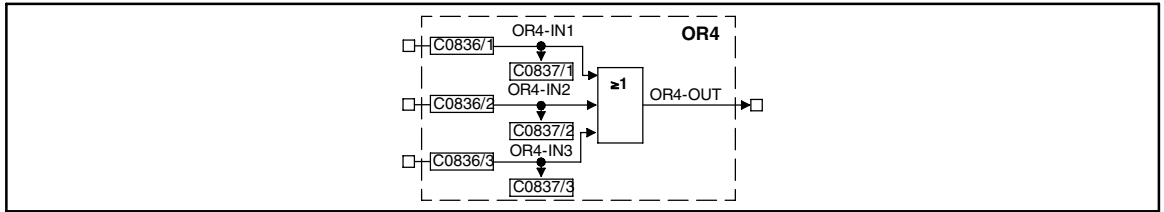

Fig. 2-117 Logic OR (OR4)

Name	Signal			Source			Note
	Type	DIS	DIS format	CFG	List	Lenze	
OR4-IN1	d	C0837/1	bin	C0826/1	2	1000	-
OR4-IN2	d	C0837/2	bin	C0826/2	2	1000	-
OR4-IN3	d	C0837/3	bin	C0826/3	2	1000	-
OR4-OUT	d	-	-	-	-	-	-

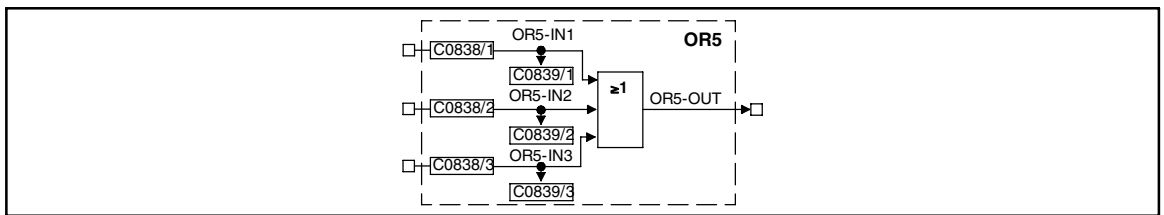
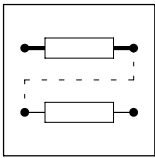

Fig. 2-118 Logic OR (OR5)

Name	Signal			Source			Note
	Type	DIS	DIS format	CFG	List	Lenze	
OR5-IN1	d	C0839/1	bin	C0828/1	2	1000	-
OR5-IN2	d	C0839/2	bin	C0828/2	2	1000	-
OR5-IN3	d	C0839/3	bin	C0828/3	2	1000	-
OR5-OUT	d	-	-	-	-	-	-



Configuration

Function blocks

Function

ORx-IN1	ORx-IN2	ORx-IN3	ORx-OUT
0	0	0	0
1	0	0	0
0	1	0	0
1	1	0	0
0	0	1	0
1	0	1	0
0	1	1	0
1	1	1	1

0 = LOW

1 = HIGH

In a contactor control, the function corresponds to a parallel connection of normally-open contacts.

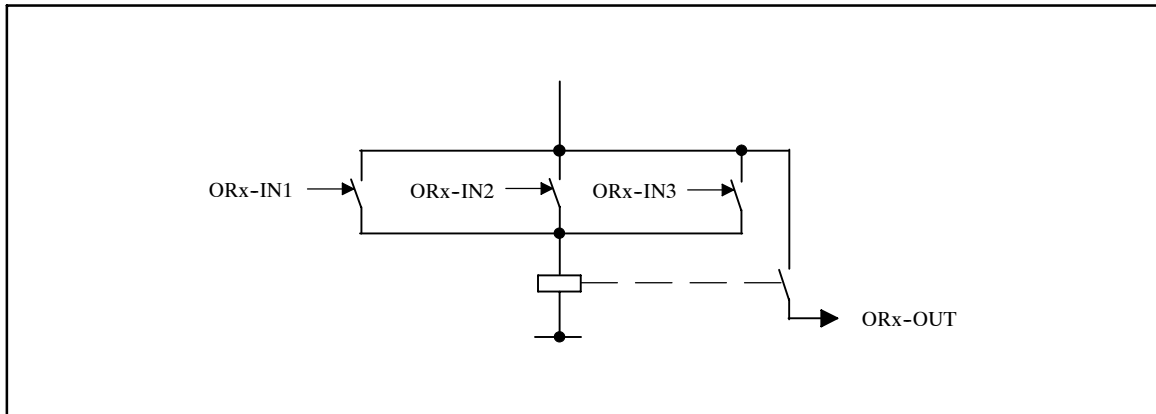

Fig. 2-119

Function of the OR operation as a parallel connection of normally-open contacts



Tip!

If only two inputs are required, use the inputs ORx-IN1 and ORx-IN2. Assign the input ORx-IN3 with the signal source FIXED0.

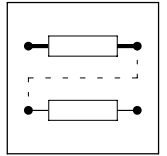

2.4.49 Oscilloscope function (OSZ)

This FB detects any measurement variables (e.g. setpoint speed, actual speed, torque, etc.) to support you in the commissioning of drives and to facilitate troubleshooting.

Measurement signals are displayed using **Global Drive Control (GDC)**.

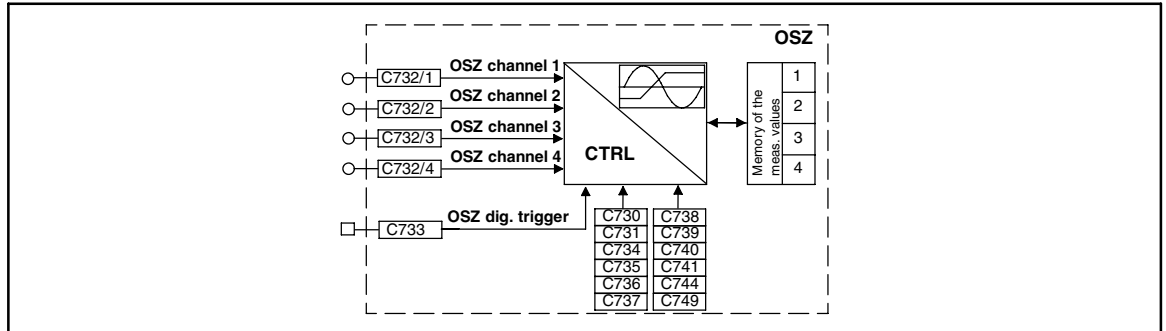

Fig. 2-120 Oscilloscope function (OSZ)

Name	Signal			Source			Note
	Type	DIS	DIS format	CFG	List	Lenze	
OSZ CHANNEL 1	a	-	-	C0732/1	1	-	-
OSZ CHANNEL 2	a	-	-	C0732/2	1	-	-
OSZ CHANNEL 3	a	-	-	C0732/3	1	-	-
OSZ CHANNEL 4	a	-	-	C0732/4	1	-	-
OSZ-DIG-TRIGGER	d	-	-	C0733/1	2	-	-

Range of functions

The FB consists of three units:

- Trigger check
 - Monitoring the digital trigger source for a valid trigger result
- Processing the measured signal
 - Linking the measurement inputs
 - Calculating the time
 - Monitoring the analog trigger source for a valid trigger result
- Memory of the measured values
 - Scaling the ring buffer memory
 - Saving measured data in the ring buffer memory
 - Saving measured points for the reconstruction of the graphic



Tip!

For a comprehensive description refer to the user's manual "Oscilloscope function".

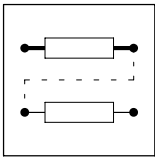

Configuration

Function blocks

2.4.50 Process controller (PCTRL)

You can use these FBs for the control of state variables such as pressure, level, dancer position, etc.

Setpoint and actual value are sent to the process controller via the corresponding inputs and processed according to the selected control algorithm (PID-, PI- or P-algorithm).

- You can adapt the gain in the FB PCTRL1.
- The FB PCTRL2 is optimal for control circuits which must be activated or deactivated online.

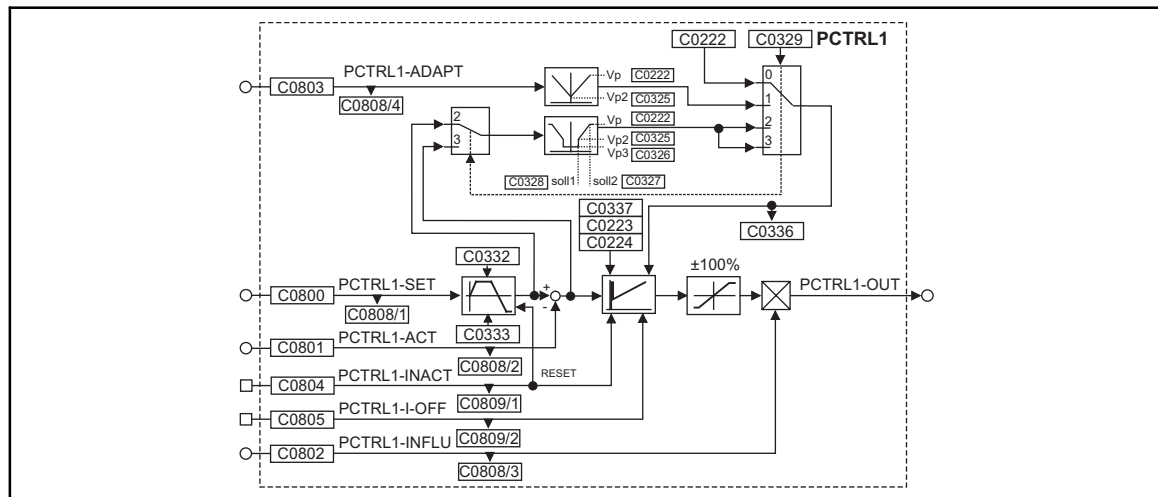

Fig. 2-121

Process controller (PCTRL1)

Name	Signal			Source			Note
	Type	DIS	DIS format	CFG	List	Lenze	
PCTRL1-SET	a	C0808/1	dec [%]	C0800	1	1000	Input for process setpoint. Possible value range: ± 200 %. The time of step-change signals can be decelerated via the ramp generator (C0332 for the acceleration time; C0333 for the deceleration time).
PCTRL1-ACT	a	C0808/2	dec [%]	C0801	1	1000	Input for actual value; value range ± 200 %
PCTRL1-INFLU	a	C0808/3	dec [%]	C0802	1	1000	Evaluation (influence) of the output signal; value range ± 200 %
PCTRL1-ADAPT	a	C0808/4	dec [%]	C0803	1	1000	Changing the gain V_p ; Value range ± 200 % (online)
PCTRL1-INACT	d	C0809/1	bin	C0804	2	1000	HIGH = Inactivation of the process controller (online)
PCTRL1-I-OFF	d	C0809/2	bin	C0805	2	1000	HIGH = switch off I component (online) LOW = switch off I component (online)
PCTRL1-OUT	a	-	-	-	-	-	-

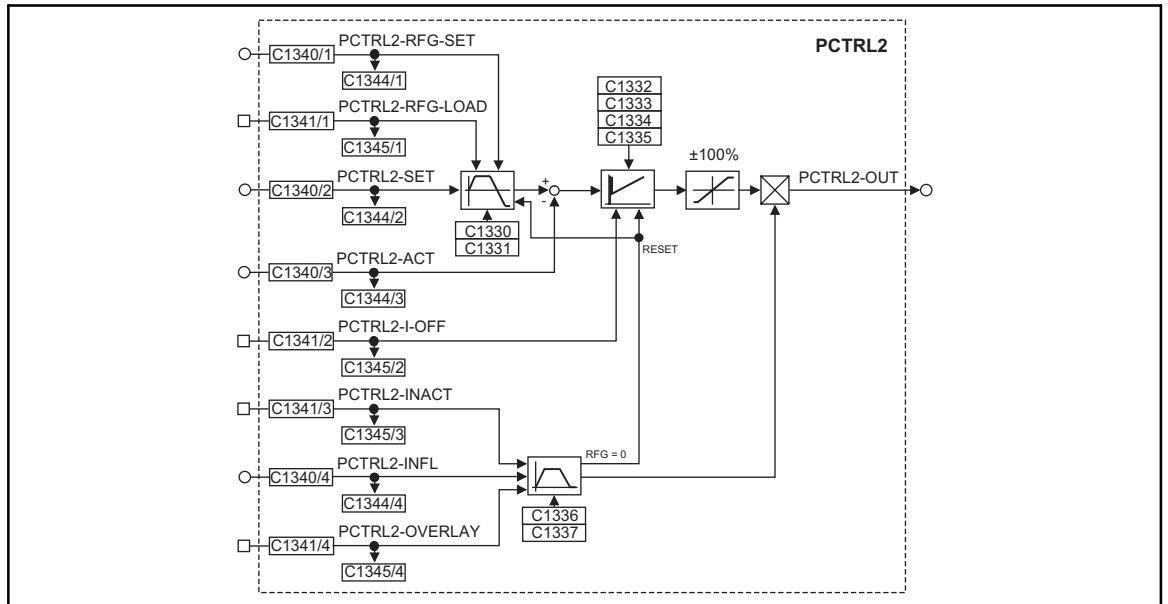
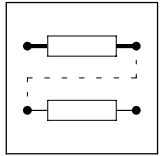
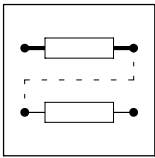

Fig. 2-122 Process controller (PCTRL2)

Name	Signal			Source			Note
	Type	DIS	DIS format	CFG	List	Lenze	
PCTRL2-RFG-SET	a	C1344/1	dec [%]	C1340/1	1	1000	The process setpoint is shown at PCTRL2-SET with any start value via a ramp generator. The function is activated using PCTRL-RFG-LOAD.
PCTRL2-RFG-LOAD	d	C1345/1	bin	C1341/1	2	1000	HIGH = Function of PCTRL2-RFG-SET is active
PCTRL2-SET	a	C1344/2	dec [%]	C1340/2	1	1000	Input for process setpoint. Possible value range: $\pm 200\%$. The time of step-change signals can be decelerated via the ramp generator (C1330 for the acceleration time; C1331 for the deceleration time).
PCTRL2-ACT	a	C1344/3	dec [%]	C1340/3	1	1000	Input for actual value; value range $\pm 200\%$
PCTRL2-INFL	a	C1344/4	dec [%]	C1340/4	1	1000	Evaluation (influence) of the output signal; value range $\pm 200\%$
PCTRL2-I-OFF	d	C1345/2	bin	C1341/2	2	1000	HIGH = switch off I component (online) LOW = switch off I component (online)
PCTRL2-INACT	d	C1345/3	bin	C1341/3	2	1000	HIGH = Inactivation of the process controller (online)
PCTRL2-OVERLAY	d	C1345/4	bin	C1341/4	2	1000	HIGH = Show influence LOW = Hide influence
PCTRL2-OUT	a	-	-	-	-	-	-

Range of functions

- Control characteristic
- Ramp generator
- Value range of the output signal
- Evaluating the output signal
- Deactivating the process controller



Configuration

Function blocks

2.4.50.1 Control characteristic

In the default setting, the PID algorithm is active.

- The D component is deactivated with
 - C0224 = 0 for PCTRL1,
 - C1334 = 0 for PCTRL2.
- The I-component is switched on or off online via the PCTRLx-I-OFF input. For this, the input is assigned a digital signal source (e.g. one of the freely assignable digital input terminals). If the I-component is to be switched off permanently, the input is assigned the signal source FIXED1.
 - PCTRLx-I-OFF = HIGH switches off the I-component.
 - PCTRLx-I-OFF = LOW switches on the I-component.
- The adjustment time T_n is parameterized via
 - C0223 for PCTRL1,
 - C1333 for PCTRL2.

Gain V_p for PCTRL1

You can adapt the gain V_p in different ways. The function for the provision of the gain V_p is selected under C0329:

- C0329 = 0
 - The gain V_p is entered under C0222.
- C0329 = 1
 - The gain V_p is entered using the input PCTRL1-ADAPT. The input value is led via a linear characteristic. The shape of the characteristic is set under C0222 (upper limit) and C0325 (lower limit). The value under C0222 is valid if the input value = +100 % or -100 %. The value under C0325 is valid if the input value = 0 %.

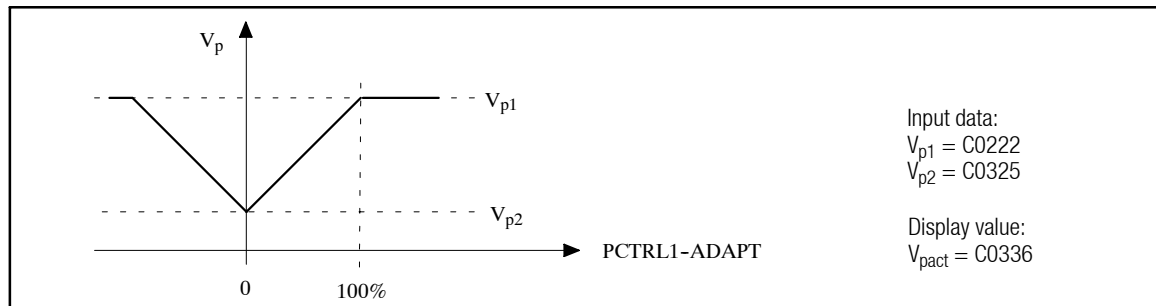
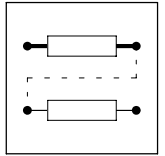

Fig. 2-123

The gain V_p is entered via input PCTRL1-ADAPT



- C0329 = 2
 - The input of gain V_p is derived from the process setpoint PCTRL1-SET. The setpoint is obtained after the ramp generator and calculated via the characteristic with three co-ordinates.

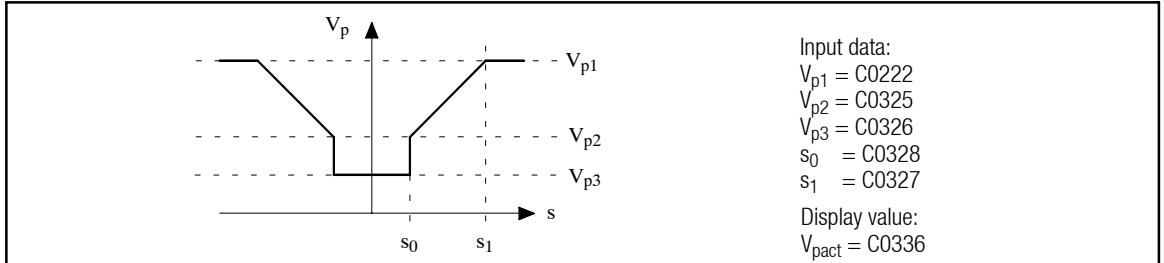

Fig. 2-124 The input of gain V_p is derived from the process setpoint PCTRL1-SET

- C0329 = 3
 - The input of gain V_p is derived from the control difference and led via the characteristic generation as C0329 = 2.

Gain V_p for PCTRL2

The gain V_p is entered under C1332.

2.4.50.2 Ramp generator

The setpoint PCTRLx-SET is led by a ramp generator with linear characteristic. Thus, setpoint step-changes at the input can be transformed into a ramp.

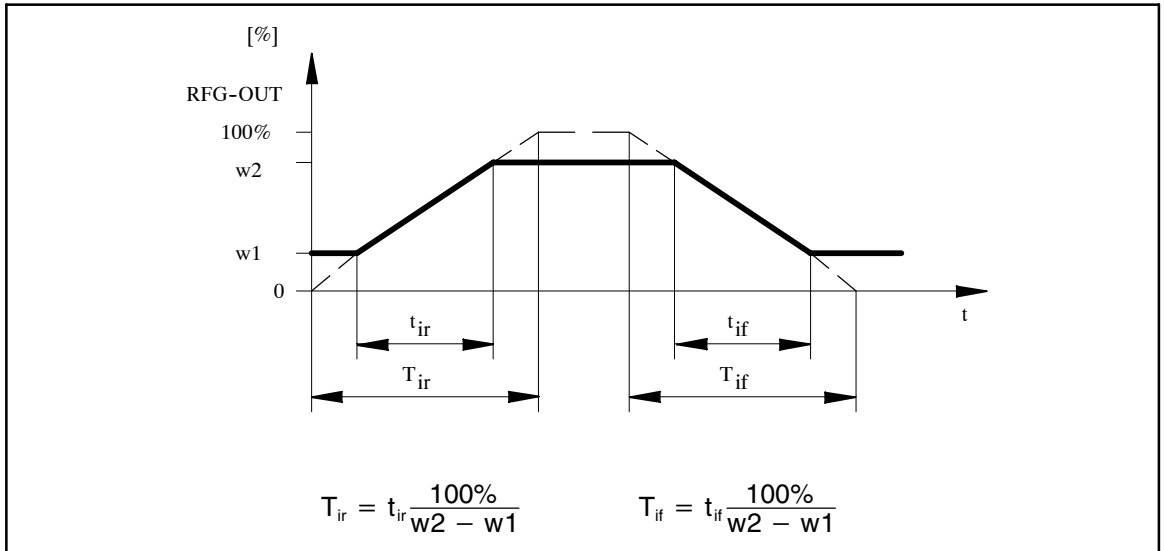
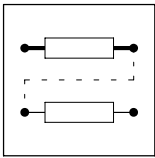

Fig. 2-125 Acceleration and deceleration times of the ramp generator

	Set ramps for acceleration and deceleration		Reset ramp generator (the ramp generator is set to 0)
	Acceleration time t_{ir}	Deceleration time t_{if}	
PCTRL1	C0332	C0333	PCTRL1-INACT = HIGH
PCTRL2	C1330	C1331	PCTRL2-INACT = HIGH



Configuration

Function blocks

Load ramp generator (only PCTRL2)

A jerk-free acting of the process controller is possible only when the setpoint ramp generator has previously been loaded with the actual value.

- PCTRL2-RFG-LOAD = HIGH activates the function.
- The start value (e.g. the actual value) is entered via PCTRL2-RFG-SET.

2.4.50.3 Value range of the output signal

Range of the process controller	PCTRL1	PCTRL2	Limitation
Bipolar (default setting)	C0337 = 0	C1335 = 0	Limits the output value to $\pm 100\%$
Unipolar	C0337 = 1	C1335 = 1	Limits the output value to 0 ... +100 %

2.4.50.4 Evaluating the output signal

After the limitation, the output signal is evaluated.

PCTRL1

You can enter the influence of the process controller via PCTRL1-INFLU.

- With PCTRL1-INFLU = 100 %, the output signal of the controller is output unchanged. The influence changes in relation to the value at PCTRL1-INFLU.

PCTRL2

The overlay function of the process controller can be slowly activated or deactivated using an internal ramp generator.

- The influence of the process controller is entered via PCTRL2-INFL.
- The influence is activated with PCTRL2-OVERLAY = HIGH.
- The influence is deactivated with PCTRL2-OVERLAY = LOW.
- Ramps for activation and deactivation:
 - C1336 = Acceleration time T_{ir}
 - C1337 = Deceleration time T_{if}

2.4.50.5 Deactivating the process controller

- The process controller is deactivated using PCTRLx-INACT = HIGH.
 - PCTRLx-OUT is set to zero.
 - The I-component is set to zero.
 - The ramp generator is set to zero.

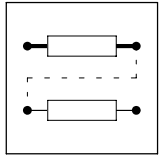

2.4.51 Delay (PT1)

These FBs are low-pass filters. They filter and delay analog signals.

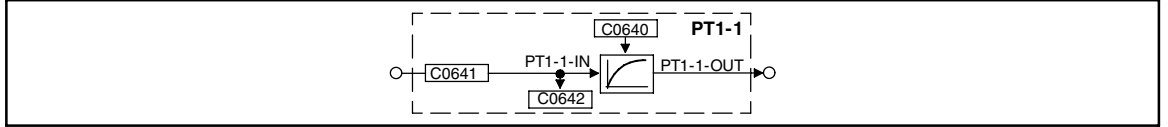

Fig. 2-126

Delay (PT1-1)

Name	Signal			Source			Note
	Type	DIS	DIS format	CFG	List	Lenze	
PT1-1-IN	a	C0642	dec [%]	C0641	1	1000	-
PT1-1-OUT	a	-	-	-	-	-	-

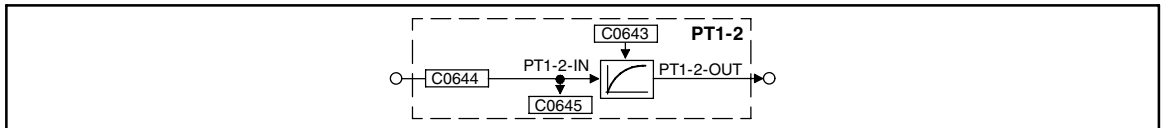

Fig. 2-127

Delay (PT1-2)

Name	Signal			Source			Note
	Type	DIS	DIS format	CFG	List	Lenze	
PT1-2-IN	a	C0645	dec [%]	C0644	1	1000	-
PT1-2-OUT	a	-	-	-	-	-	-

Function

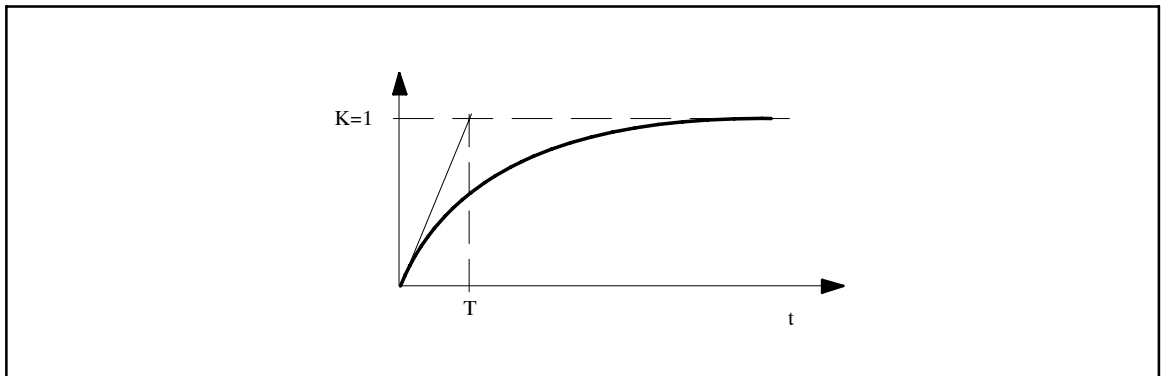
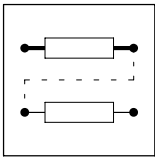

Fig. 2-128

Delay behaviour of PT1

- The delay T is set under C0640 (PT1-1) or C0643 (PT1-2).
- The proportional value is fixed at $K = 1$.



Configuration

Function blocks

2.4.52 Ramp function generator (RFG)

This FB converts step changes into ramps. The output signal follows the input signal with limited rate of rise.

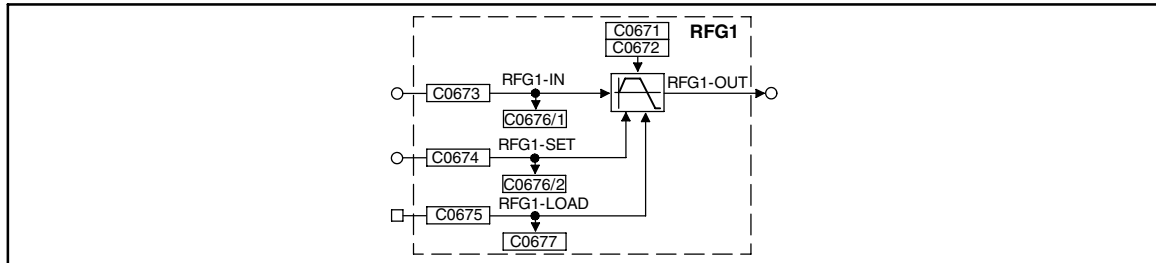

Fig. 2-129

Ramp generator (RFG1)

Name	Signal			Source			Note
	Type	DIS	DIS format	CFG	List	Lenze	
RFG1-IN	a	C0676/1	dec [%]	C0673	1	1000	-
RFG1-SET	a	C0676/2	dec [%]	C0674	1	1000	-
RFG1-LOAD	d	C0677	-	C0675	2	1000	-
RFG1-OUT	a	-	-	-	-	-	-

Range of functions

- Ramp function generator
- Load ramp generator

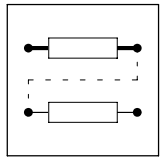

2.4.52.1 Ramp function generator

The maximum speed of change with which the output signal can follow the input signal, is parameterized via the acceleration and deceleration time of the ramp function generator. They refer to a change of the output signal from 0 to 100%. The times to be set T_{ir} and T_{if} are to be calculated as follows:

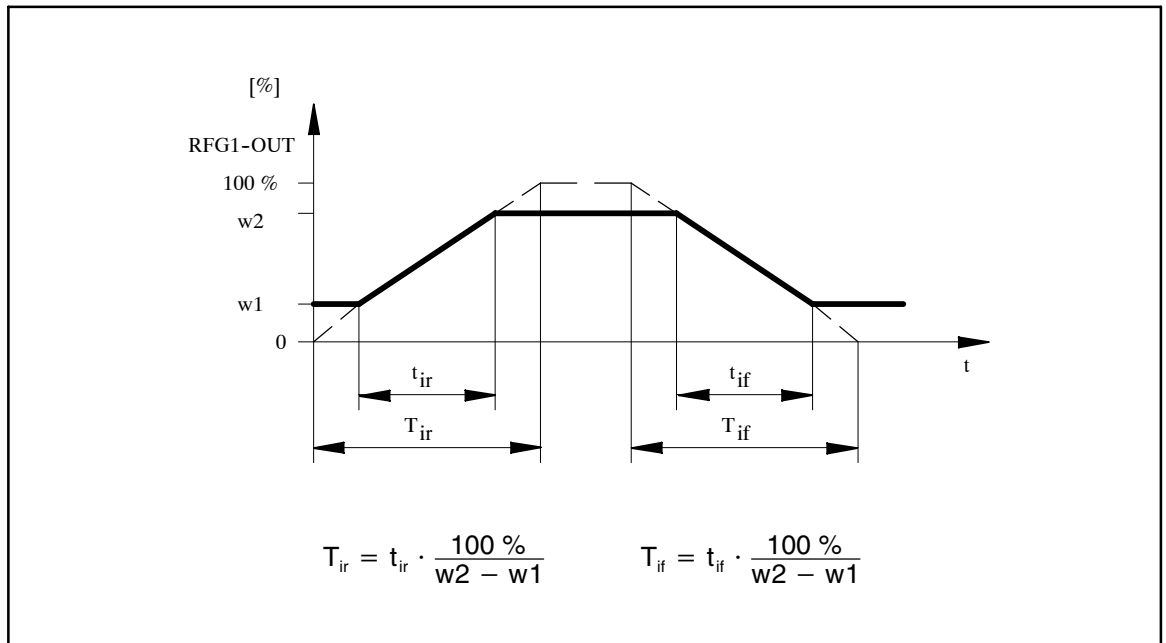

Fig. 2-130 Acceleration and deceleration times of the ramp function generator

Here, t_{ir} and t_{if} are the desired times for the change between $w1$ and $w2$. You can set the calculated value under C0671 (T_{ir}) and C0672 (T_{if}).

2.4.52.2 Load ramp function generator

You can initialize the ramp function generator with defined values via the inputs RFG1-SET and RFG1-LOAD.

- As long as RFG1-LOAD = HIGH, the value at RFG1-SET is switched to RFG1-OUT.
- If the RFG1-LOAD = LOW, the ramp function generator accelerates from this value to its input value at REG1-IN via the set T_i times.

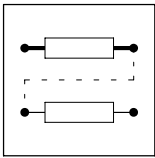

Configuration

Function blocks

2.4.53 CW/CCW/Quick stop (R/L/Q)

This FB evaluates the input of the direction of rotation protected against wire breakage. If there is no signal for the direction of rotation, quick stop is released.

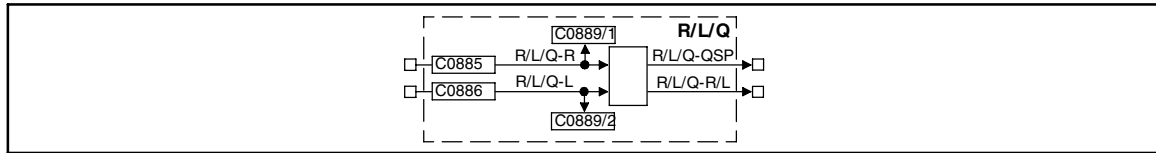

Fig. 2-131

CW/CCW/Quick stop (R/L/Q)

Name	Signal			Source			Note
	Type	DIS	DIS format	CFG	List	Lenze	
R/L/Q-R	d	C0889/1	bin	C0885	2	51	-
R/L/Q-L	d	C0889/2	bin	C0886	2	52	-
R/L/Q-QSP	d	-	-	-	-	-	-
R/L/Q-R/L	d	-	-	-	-	-	-

Function

- After mains connection, the two outputs are initialized as follows:

Inputs		Outputs	
R/L/Q-R	R/L/Q-L	R/L/Q-R/L	R/L/Q-QSP
-	-	0	1

0 = LOW

1 = HIGH

- After the initialization, the following relationship results in dependence of the input signals:

Inputs		Outputs	
R/L/Q-R	R/L/Q-L	R/L/Q-R/L	R/L/Q-QSP
0	0	0/1*	1
1	0	0	0
0	1	1	0
1	1	unchanged	unchanged

0 = LOW

1 = HIGH

* If you have selected a direction of rotation and then set both inputs to LOW, the signal state at R/L/Q-R/L will not change.

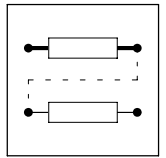

2.4.54 Sample & Hold (S&H)

This FB can accept analog signals and save them non-volatile. The saved value is also available after mains disconnection.

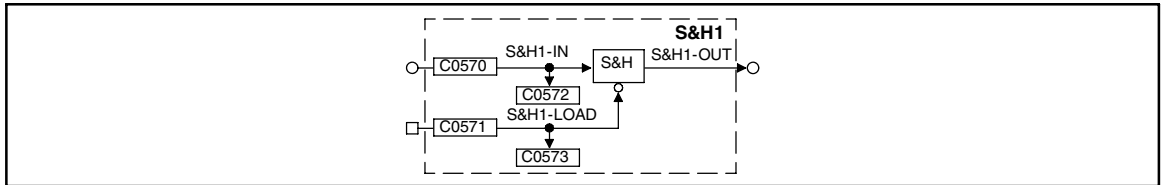

Fig. 2-132

Sample & Hold (S&H1)

Name	Signal			Source			Note
	Type	DIS	DIS format	CFG	List	Lenze	
S&H1-IN	a	C0572	dec [%]	C0570	1	1000	
S&H1-LOAD	d	C0573	bin	C0571	2	1000	LOW = save
S&H1-OUT	a	-	-	-	-	-	

Function

- With S&H1-LOAD = HIGH the signal at the input S&H1-IN is switched to the output S&H1-OUT.
- With S&H1-LOAD = LOW the output S&H1-OUT is disconnected from the input S&H1-IN and outputs the value which was last valid and S&H-OUT outputs the value which was accepted last.
- Saving before mains disconnection:
 - The value which was accepted last is saved non-volatile in the internal memory before the supply voltage is switched off. When the supply voltage is switched on, the saved value is loaded into the FB S&H1.

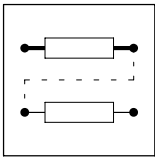

Configuration

Function blocks

2.4.55 Square-root calculator (SQRT)

This FB calculates the square-root from the absolute value of the input signal and then adds the sign again. This is used to convert state variables with their relationship.

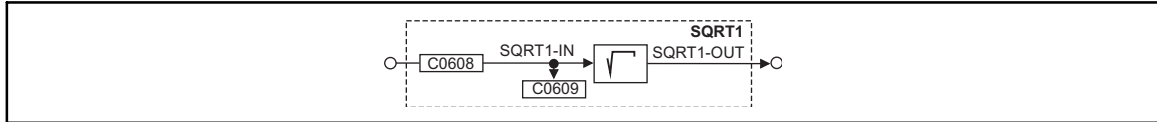

Fig. 2-133

Square-root calculator (SQRT1)

Name	Signal			Source			Note
	Type	DIS	DIS format	CFG	List	Lenze	
SQRT1-IN	a	C0609	dec [%]	C0608	1	1000	-
SQRT1-OUT	a	-	-	-	-	-	-

Function

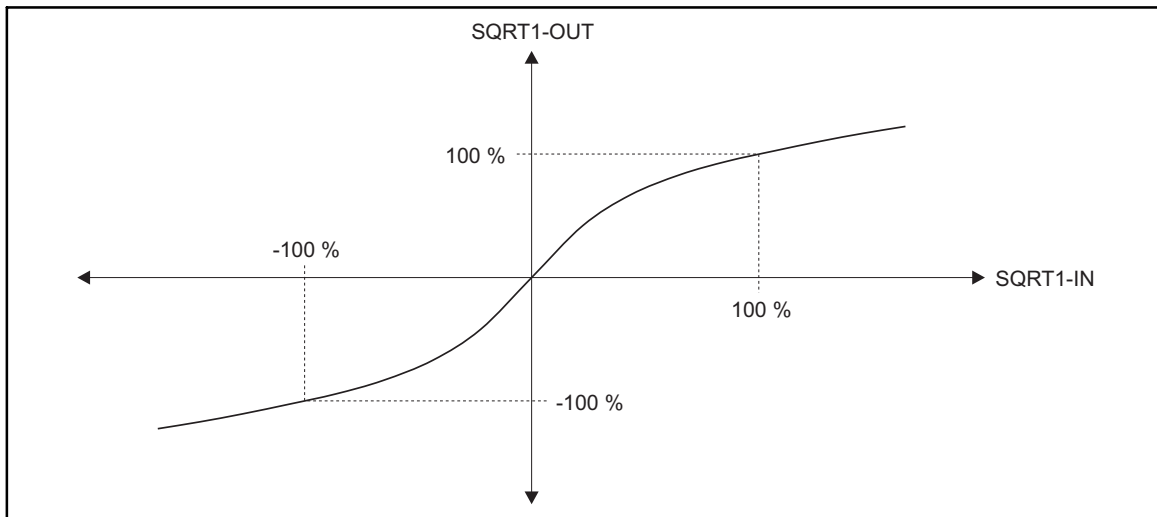
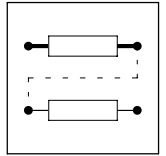

Fig. 2-134

Characteristic of the output signal at SQRT1-OUT to the input signal at SQRT1-IN

When the input signal at SQRT1-IN = 100 %, the output signal at SQRT1-OUT = 100 %.



2.4.56 S-ramp function generator (SRFG)

This FB converts setpoint step changes into S-shaped ramps. Thus, you can accelerate the drive practically jolt-free.

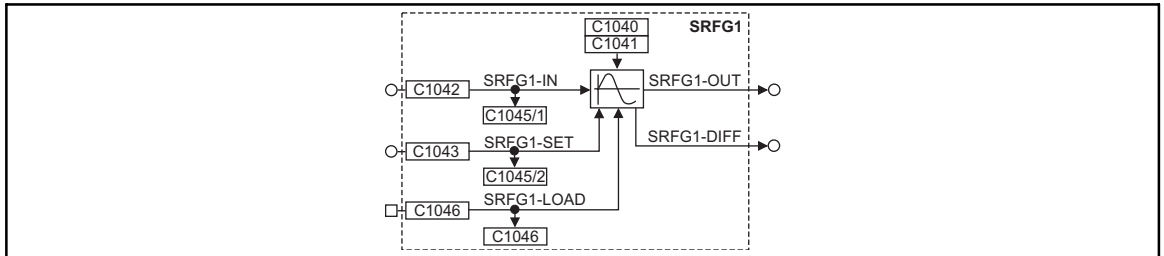
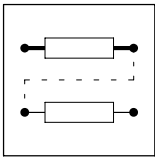

Fig. 2-135 S-ramp function generator (SRFG1)

Name	Signal			Source		Note
	Type	DIS	DIS format	CFG	List	
SRFG1-IN	a	C1045/1	dec [%]	C1042	1	Input
SRFG1-SET	a	C1045/2	dec [%]	C1043	1	Start value for the ramp function generator, acceptance when SRFG1-LOAD = High
SRFG1-LOAD	d	C1046	bin	C0144	2	HIGH = accepts the value at SRFG1-SET and supplies it to SRFG1-OUT; SRFG1-DIFF remains at 0 %
SRFG1-OUT	a	-	-	-	-	Output limited to ± 100 %
SRFG1-DIFF	a	-	-	-	-	Output limited to ± 100 %, supplies the acceleration of the ramp function generator

Range of functions

- Ramp function generator
- Load ramp function generator



Configuration

Function blocks

2.4.56.1 Ramp function generator

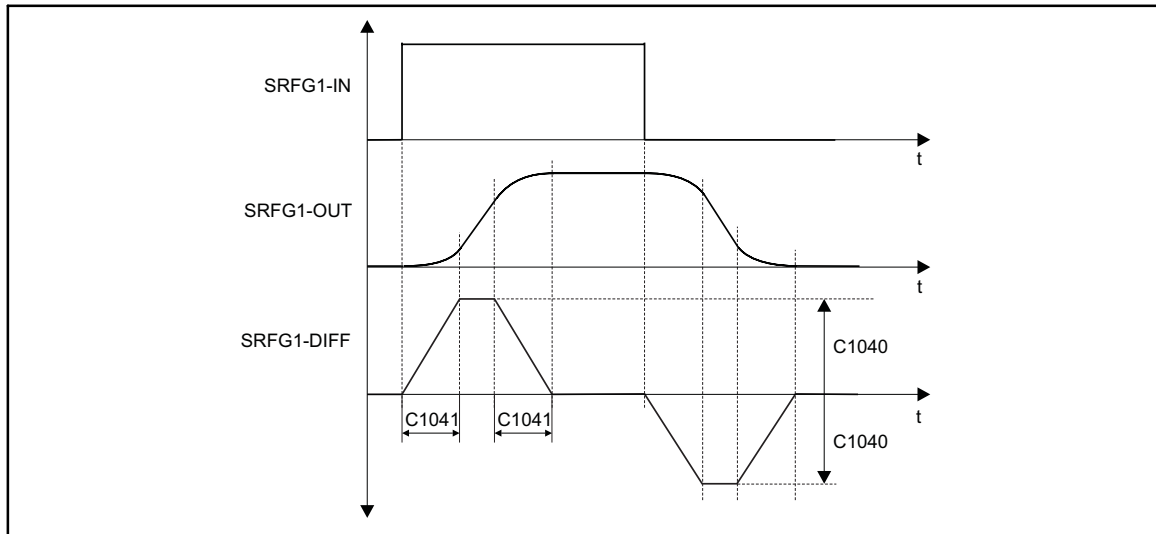

Fig. 2-136 Characteristic of the ramp function generator

The s-shaped characteristic of the output signal is parameterized via the max. acceleration (C1040) and the rounding time (C1041).

- The max. acceleration is entered as a percentage, which the output signal is allowed to pass per second.
- During the rounding time (C1041), from zero acceleration to maximum acceleration (or from maximum acceleration to zero acceleration), the acceleration changes in a linear way.
 - The acceleration characteristic (signal at SRFG-DIFF) in Fig. 2-136 shows the linear rising or falling of the signal during the rounding time (C1041).

Calculation of the max. acceleration

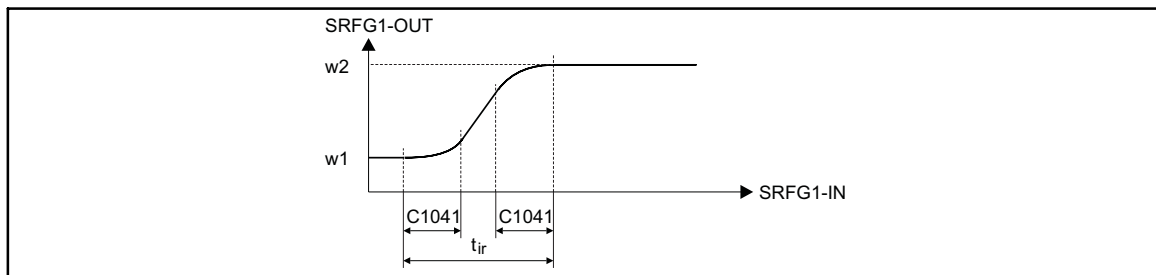
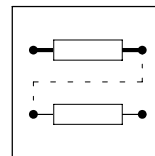

Fig. 2-137 Signal characteristic with jolt-free acceleration

Calculate the necessary max. acceleration for the change between w1 and w2 in the desired time t_{ir} according to the following formula:

$$C1040 = \frac{W1 - W2}{t_{ir} - C1041}$$



2.4.56.2 Load ramp function generator

You can initialize the ramp function generator with defined values via the inputs SRFG1-SET and SRFG1-LOAD.

- As long as SRFG1-LOAD = HIGH, the value at SRFG1-SET is switched to SRFG1-OUT.
- When SRFG1-LOAD = LOW, the ramp generator accelerates from this value to its input value at SRFG1-IN via the set S-shape.

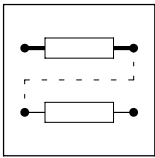

Configuration

Function blocks

2.4.57 Output of digital status signals (STAT)

The FB accepts digital signals of the function blocks and the status of the controller and passes them on to C0150 and to the FB AIF-OUT and CAN-OUT1.

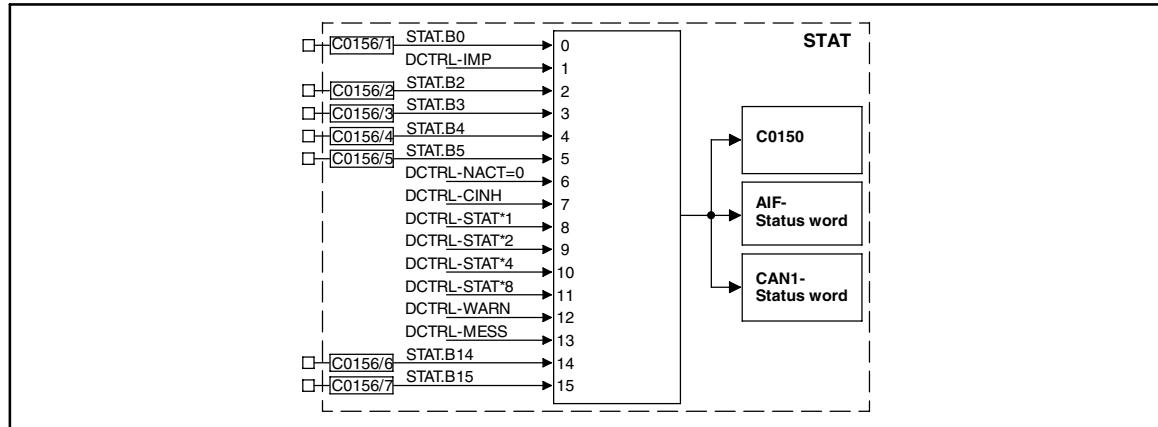

Fig. 2-138 Output of digital status signals (STAT)

Name	Signal			Source			Note
	Type	DIS	DIS format	CFG	List	Lenze	
STAT.B0	d	-	bin	C0156/1	2	2000	-
STAT.B2	d	-	bin	C0156/2	2	5002	-
STAT.B3	d	-	bin	C0156/3	2	5003	-
STAT.B4	d	-	bin	C0156/4	2	5050	-
STAT.B5	d	-	bin	C0156/5	2	10650	-
STAT.B14	d	-	bin	C0156/6	2	505	-
STAT.B15	d	-	bin	C0156/7	2	500	-

Function

The status word consists of some linked (DCTRL-xxxx-) and some freely linkable signal inputs (STAT.Bx).

- Digital signal sources can be freely assigned to the inputs STAT.Bx.
- The corresponding bit in the data word is marked with STAT.Bx (e.g. STAT.B0 for the least significant bit).
- The status word is transferred to code C0150 and to the function blocks AIF-OUT, CAN-OUT1, CAN-OUT2, and CAN-OUT1.
- The inputs with the name DCTRL-xxxx are directly accepted from the function block DCTRL.
(2-84)

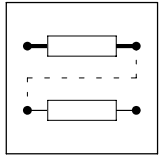

2.4.58 Edge evaluation (TRANS)

These FBs evaluate the switching edges of the input signals and generate pulses. The pulse length can be set.

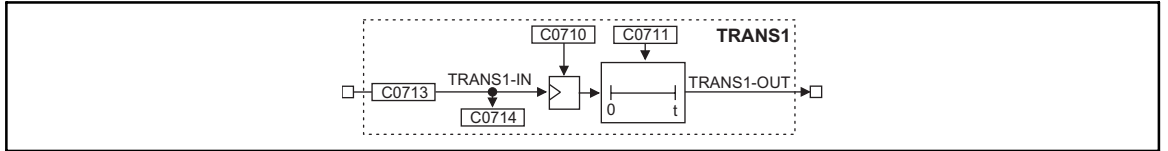

Fig. 2-139 Edge evaluation (TRANS1)

Name	Signal			Source			Note
	Type	DIS	DIS format	CFG	List	Lenze	
TRANS1-IN	d	C0714	bin	C0713	2	1000	-
TRANS1-OUT	d	-	-	-	-	-	-

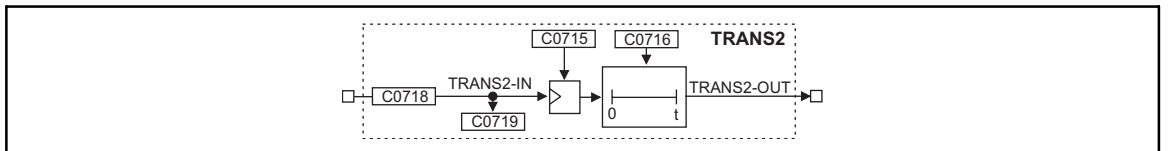
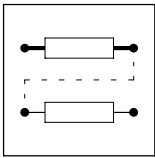

Fig. 2-140 Edge evaluation (TRANS2)

Name	Signal			Source			Note
	Type	DIS	DIS format	CFG	List	Lenze	
TRANS2-IN	d	C0719	bin	C0718	2	1000	-
TRANS2-OUT	d	-	-	-	-	-	-

Range of functions

- Evaluate positive edge
- Evaluate negative edge
- Evaluate positive or negative edge



Configuration

Function blocks

2.4.58.1 Evaluate positive edge

- C0710 = 0 (TRANS1)
- C0715 = 0 (TRANS2)

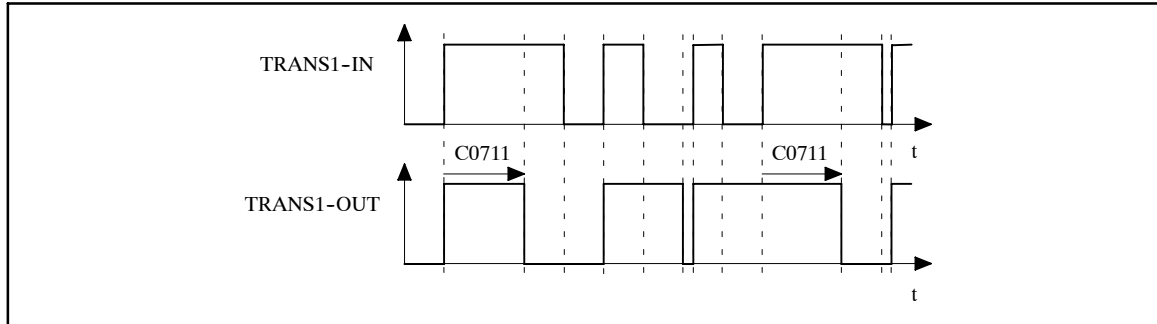

Fig. 2-141

Evaluation of positive edges (TRANS1)

Function procedure

1. With a LOW-HIGH edge at TRANSx-IN, TRANSx-OUT = HIGH.
2. After the time set under C0711 (TRANS1) or C0716 (TRANS2) has elapsed, TRANSx-OUT switches to LOW again.
 - Every new trigger event (LOW-HIGH edge at TRANSx-IN) switches TRANSx-OUT = HIGH and restarts the elapsing time.

2.4.58.2 Evaluate negative edge

- C0710 = 1 (TRANS1)
- C0715 = 1 (TRANS2)

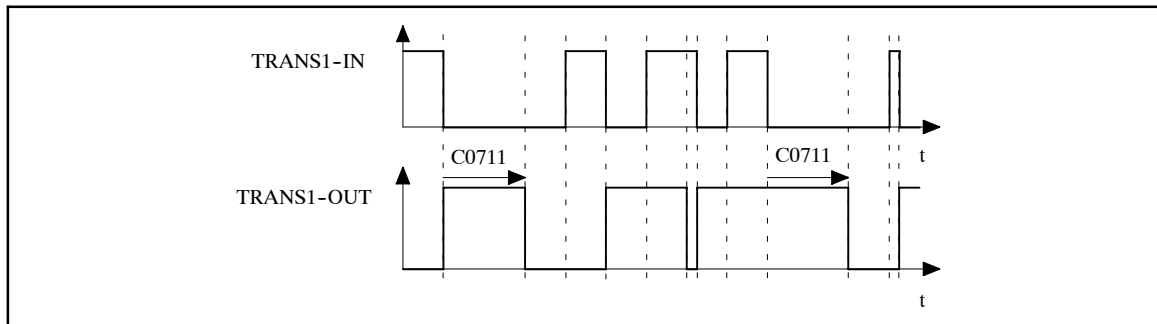
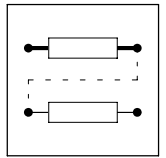

Fig. 2-142

Evaluation of negative edges (TRANS1)

Function procedure

1. With a HIGH-LOW edge at TRANSx-IN, TRANSx-OUT = HIGH.
2. After the time set under C0711 (TRANS1) or C0716 (TRANS2) has elapsed, TRANSx-OUT switches to LOW again.
 - Every new trigger event (LOW-HIGH edge at TRANSx-IN) switches TRANSx-OUT = HIGH and restarts the elapsing time.



2.4.58.3 Evaluate positive or negative edge

- C0710 = 2 (TRANS1)
- C0715 = 2 (TRANS2)

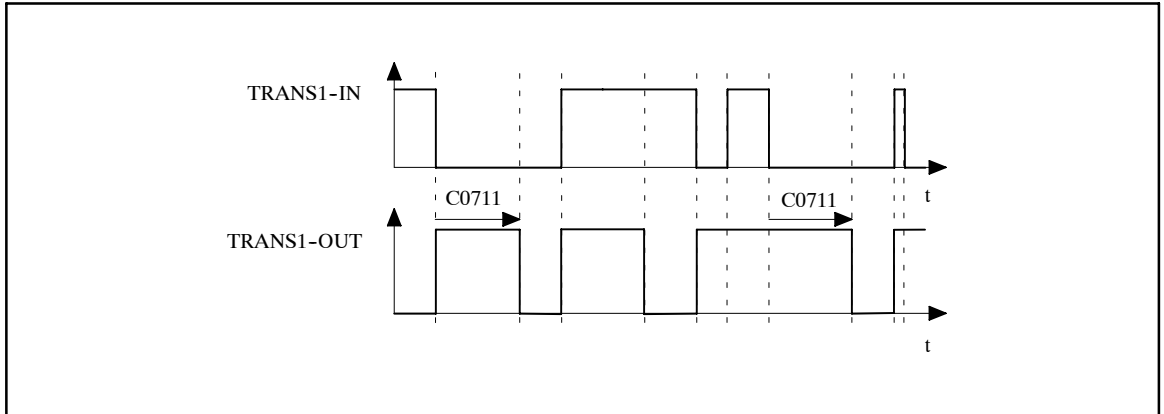
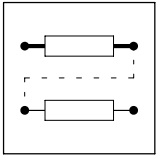

Fig. 2-143 Evaluation of positive and negative edges (TRANS1)

Function procedure

1. With a HIGH-LOW edge or a LOW-HIGH edge at TRANSx-IN, TRANSx-OUT = HIGH.
2. After the time set under C0711 (TRANS1) or C0716 (TRANS2) has elapsed, TRANSx-OUT switches to LOW again.
 - Every new trigger event (LOW-HIGH edge or HIGH-LOW edge at TRANSx-IN) switches TRANSx-OUT = HIGH and restarts the elapsing time.



Configuration

Monitorings

2.5 Monitorings

Different monitoring functions protect the drive from impermissible operating conditions.

If a monitoring function responds,

- a corresponding response is activated to protect the drive,
- a digital output is set, if it has been assigned with the corresponding response,
- the error number is entered on top of the history buffer.

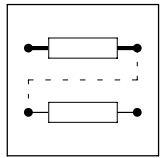

2.5.1 Monitoring functions

List of error sources detected by the controller and the corresponding responses

Display	Meaning	TRIP	Message	Warning	Off	Code
CCr	System error	•	-	-	-	-
CE0	AICommunication error	✓	-	✓	•	C0126
CE1	Communication error at process data input object CAN-IN1 (time monitoring can be set under C0357/1)	✓	-	✓	•	C0591
CE2	Communication error at process data input object CAN-IN2 (time monitoring can be set under C0357/2)	✓	-	✓	•	C0592
CE3	Communication error at process data input object CAN-IN3 (time monitoring can be set under C0357/3)	✓	-	✓	•	C0593
CE4	BUS-OFF status (too many communication errors have occurred)	✓	-	✓	•	C0595
EEr	External monitoring	•	✓	✓	✓	C0581
H05, H07	Internal fault	•	-	-	-	-
H10	Sensor fault - heatsink temperature	•	-	-	✓ ¹⁾	C0588
H11	Sensor fault - inside temperature	•	-	-	✓ ¹⁾	
ID1	Motor identification failed - characteristic	•	-	-	-	-
ID2	Motor identification failed - motor data	•	-	-	-	-
LP1	Motor phase failure detection (function block must be entered in C0465)	✓	-	✓	•	C0597
LU	Undervoltage	-	•	-	-	-
NMAX	Maximum speed exceeded (C0596)	•	-	-	-	-
OC1	Short circuit	•	-	-	-	-
OC2	Earth fault (EVF9321 ... EVF9333)	•	-	-	✓	C0574
	Earth fault (EVF9335 ... EVF9338, EVF9381 ... EVF9383)	•	-	-	-	
OC3	Overload during acceleration or deceleration	•	-	-	-	-
OC5	l x t overload	-	-	•	-	-
OH	Heatsink temperature 1 (max. permissible, fixed)	•	-	-	-	-
OH3	Motor temperature 1 (max. permissible, fixed)	✓	-	-	•	C0583
OH4	Heatsink temperature 2 (adjustable; C0122)	-	-	•	✓	C0582
OH7	Motor temperature 2 (adjustable; code: C0121)	-	-	✓	•	C0584
OH8	Motor temperature (fixed) via inputs T1/T2	✓	-	✓ ²⁾	•	C0585
OU	DC bus overvoltage	-	-	•	-	-
PEr	Program error	•	-	-	-	-
PI	Error during initialisation	•	-	-	-	-
PR0	General error in parameter sets	•	-	-	-	-
PR1	Error in parameter set 1	•	-	-	-	-
PR2	Error in parameter set 2	•	-	-	-	-
PR3	Error in parameter set 3	•	-	-	-	-
PR4	Error in parameter set 4	•	-	-	-	-
Sd3	Encoder error at pin X9/8	✓	-	✓ ²⁾	•	C0587
Sd5	Encoder error at X6/1 X6/2 (C0034 = 1)	✓	-	✓	•	C0598
Sd6	Sensor error: motor temperature (X7 or X8)	✓	-	✓	•	C0594

- Default setting
- ✓ Possible
- Not possible
- ✓¹⁾ Possible, but may destroy the controller, unless the error is removed in time
- ✓²⁾ Possible, but may destroy the motor, unless the error is removed in time

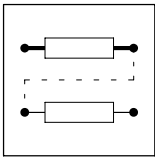

Configuration

Monitorings

2.5.2 System monitoring (CCr)

Monitoring serves to protect the controller. It responds if the program flow of the processor is faulty (system failure). In this case, the operation will be interrupted for safety reasons.

Reaction	Error number LECOM
TRIP	0071

2.5.3 Communication monitoring (CE0)

This monitoring responds when there is a communication fault with a fieldbus module connected to an automation interface X1.

Adjustable reactions	Error number LECOM
TRIP	0061
Warning	2061
Off	–

2.5.4 Communication monitoring (CE1, CE2, CE3)

This monitoring CE1 (CAN-IN1), CE2 (CAN-IN2) or CE3 (CAN-IN3) responds if no data or faulty data are received within the monitoring time (C0357/1 ... C0357/3). Nevertheless, the corresponding process data input object remains in receive position.

Adjustable reactions	Error number LECOM		
	CE1	CE2	CE3
TRIP	0062	0063	0064
Warning	2062	2063	2064
Off	–	–	–

2.5.5 Communication monitoring (CE4)

If faulty telegrams occur too frequently, the controller switches to the BUS-OFF state and the monitoring responds.

Adjustable reactions	Error number LECOM
TRIP	0065
Warning	2065
Off	–

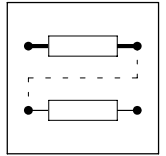

2.5.6 Monitoring of the external encoder (EEr)

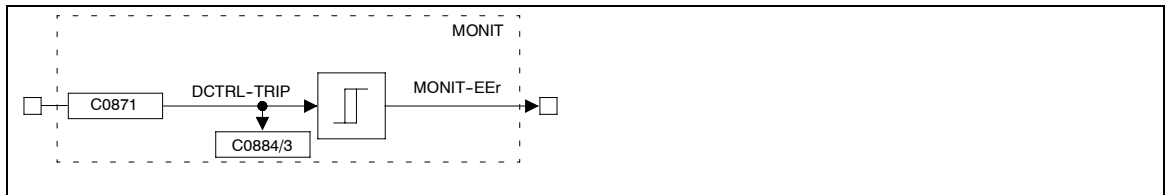

Fig. 2-144 Monitoring by the external encoder (EEr)

Name	Signal			Source			Note
	Type	DIS	DIS format	CFG	List	Lenze	
DCTRL-TRIP	d	C0884/3	bin	C0871	2	54	-
MONIT-EER	d	-	-	-	-	-	-

The monitoring responds to a HIGH level at the input DCTRL-TRIP-SET. In the Lenze setting this input is connected with the terminal X5/E4. This enables external encoders to release a fault message at X5/E4.

The input DCTRL-TRIP-SET can also be controlled with other binary signal sources.

Adjustable reactions	Error number LECOM
TRIP	0091
Message	1091
Warning	2091
Off	-

2.5.7 Monitoring of the thermal sensors inside the device (H10, H11)

The monitoring H10 (heatsink temperature) or H11 (temperature inside the controller) responds if an error in the internal temperature detection was detected during mains connection.

The fault message is only saved in the history buffer.

Adjustable reactions	Error number LECOM	
	H10	H11
TRIP	0110	0111
Off	-	-

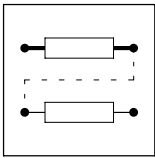

Configuration

Monitorings

2.5.8 Monitoring of the motor phases (LP1)

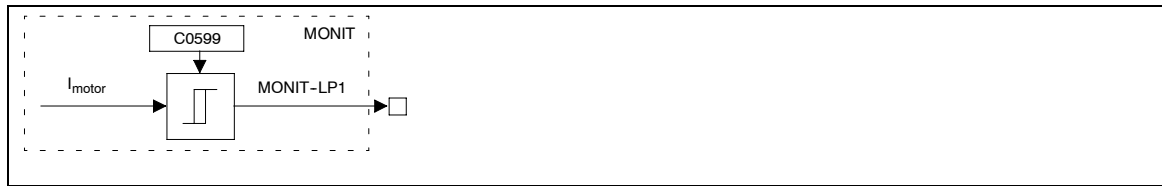

Fig. 2-145

Monitoring of the motor phases (LP1)

Name	Signal			Source			Note
	Type	DIS	DIS format	CFG	List	Lenze	
I _{MOTOR}	-	-	-	-	-	-	-
MONIT-LP1	d	-	-	-	-	-	-

This monitoring responds if the current-carrying motor phase fails, the motor winding is broken or the current limit value is set too high (C0599).

This monitoring is not suitable for field frequencies > 480 Hz and when using synchronous servo motors; deactivate the monitoring (C0597 = 3).



Note!

To activate the monitoring of the motor phases, enter the FB MLP1 in the processing table.

Adjustable reactions	Error number LECOM
TRIP	0032
Warning	2032
Off	-

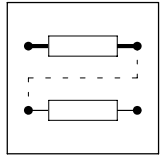

2.5.9 Monitoring of the maximum speed (NMAX)



Danger!

The following must be observed with active loads:

- If monitoring responds, the drive gets torqueless!
- Special, plant-specific measures are required.
- If the actual speed encoder fails, it is not ensured that the monitoring responds.

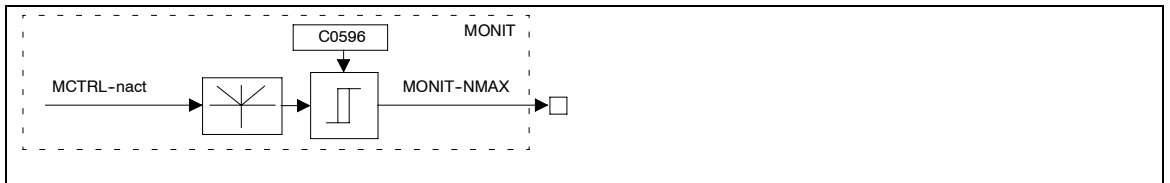

Fig. 2-146 Maximum speed monitoring (NMAX)

Name	Signal			Source			Note
	Type	DIS	DIS format	CFG	List	Lenze	
MCTRL-NACT	-	-	-	-	-	-	Cannot be reassigned
MONIT-NMAX	d	-	-	-	-	-	-

If the current speed exceeds the limit set in C0596 or the maximum speed n_{max} (C0011) by double the amount, the monitoring responds.

Reaction	Error number LECOM
TRIP	0200

2.5.10 Short-circuit monitoring (OC1)

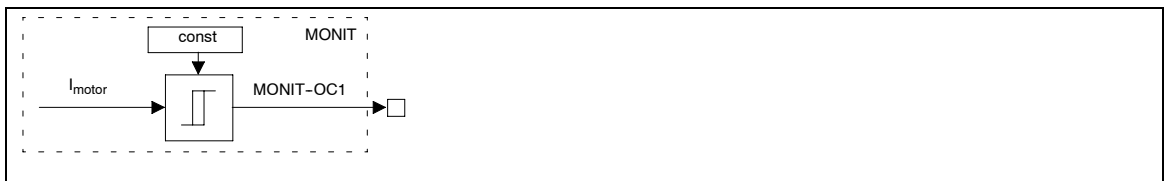
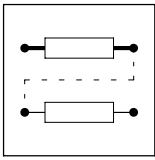

Fig. 2-147 Short-circuit monitoring (OC1)

Name	Signal			Source			Note
	Type	DIS	DIS format	CFG	List	Lenze	
I_MOTOR	-	-	-	-	-	-	-
MONIT-OC1	d	-	-	-	-	-	-

This hardware monitoring responds in case of overcurrent (motor current > 2.25-fold rated controller current).

Reaction	Error number LECOM
TRIP	0011



Configuration

Monitorings

2.5.11 Short-circuit monitoring (OC2)

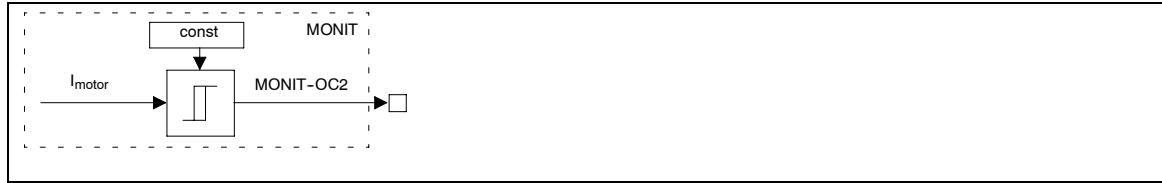

Fig. 2-148 Earth-fault monitoring (OC2)

Name	Signal			Source			Note
	Type	DIS	DIS format	CFG	List	Lenze	
I _{MOTOR}	-	-	-	-	-	-	-
MONIT-OC2	d	-	-	-	-	-	-

The controllers of the 93XX series are equipped with an earth fault detection as a standard.

The monitoring responds in case of a short circuit to frame of the machine, a short circuit of a phase to the shield, a short circuit of a phase to PE or a too high capacitive charging current of the motor cable.

Response of EVF9321 ... EVF9333controllers

The monitoring can be deactivated under C0574. After deactivation, the controller will not make an earth-fault test after controller enable.

Adjustable reactions	Error number LECOM
TRIP	0012
Off	-

Response of EVF9335 ... EVF9338 and EVF9381 ... EVF9383controllers

Reaction	Error number LECOM
TRIP	0012

2.5.12 Overload monitoring for acceleration and deceleration (OC3)

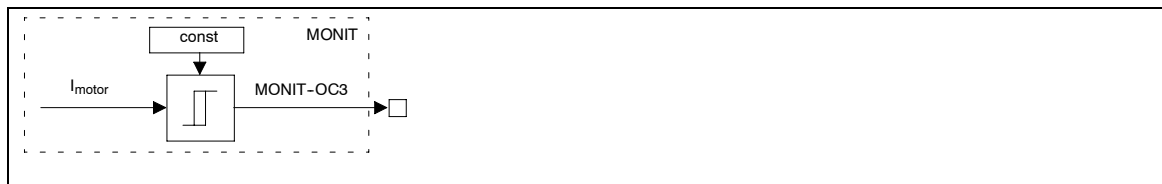
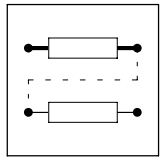

Fig. 2-149 Overload during acceleration or deceleration OC3

Name	Signal			Source			Note
	Type	DIS	DIS format	CFG	List	Lenze	
I _{MOTOR}	-	-	-	-	-	-	-
MONIT-OC3	d	-	-	-	-	-	-

If the load is too high during deceleration (too short acceleration and deceleration times in C0012, C0013, C0105 in proportion to the load), the monitoring responds.

Reaction	Error number LECOM
TRIP	0013



2.5.13 I x t overload monitoring (OC5)

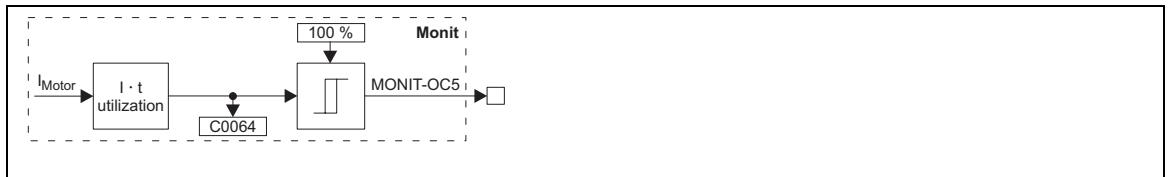

Fig. 2-150

I x t overload (OC5)

Name	Signal			Source			Note
	Type	DIS	DIS format	CFG	List	Lenze	
IMOTOR	-	C0064	dec [%]	-	-	-	-
MONIT-OC5	d	-	-	-	-	-	-

When monitoring the I x t overload, the output current of the controller is monitored.

The controller load is calculated from the average value of the motor current over a time of 180 s. A load of 100 % is obtained when the controller is operated with rated power (150 % overload capacity). C0064 indicates the load.

If a load of 100 % is reached, the monitoring responds.

Reaction	Error number LECOM
Warning	2015



Note!

Operation of types EVF9321 ... EVF9333 with increased rated power

- For operations with increased rated power (120 % overload capacity) the warning OC5 can be ignored. The controller load can permanently be above 100 %.
- If "autochop" is set (C0018 = 0 or 6) and with a load of > 140 %, the switching frequency is lowered and the maximum current is reduced.

2.5.14 Monitoring of the heatsink temperature with fixed threshold (OH)



Fig. 2-151

Monitoring of the heatsink temperature, with fixed threshold (OH)

Name	Signal			Source			Note
	Type	DIS	DIS format	CFG	List	Lenze	
TEMP-COOLER	-	C0061	dec	-	-	-	Cannot be reassigned
MONIT-OH	d	-	-	-	-	-	-

If the heatsink temperature exceeds the value that is firmly set in the controller, the monitoring responds.

The switch-off threshold is fixed and amounts to 85 °C. The hysteresis is also fixed and amounts to 5 K, i.e. the reclosing point is at 80 °C.

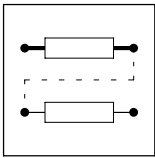

Configuration

Monitorings

Reaction	Error number LECOM
TRIP	0050

2.5.15 Monitoring of the heatsink temperature with adjustable threshold (OH4)



Fig. 2-152 Monitoring of the heatsink temperature, with adjustable threshold (OH4)

Name	Signal			Source			Note
	Type	DIS	DIS format	CFG	List	Lenze	
TEMP-COOLER	-	C0061	dec	-	-	-	Cannot be reassigned
MONIT-OH4	d	-	-	-	-	-	-

The monitoring is designed as an early warning before the controller is disconnected (OH).

The process can be influenced in such a way that the controller will not be disconnected at a wrong time. For instance, fans can be activated which could lead to unacceptable noise developments during continuous operation.

The operating threshold can be set in C0122. The hysteresis is fixed and amounts to 5 K, i.e. the signal is cancelled at 5 K below the operating threshold.

Adjustable reactions	Error number LECOM
Warning	2054
Off	-

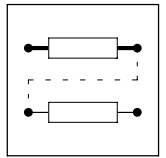

2.5.16 Motor temperature monitoring (OH8)



Stop!

If the monitoring is set to warning or Off, the motor can be destroyed by overload.



Fig. 2-153 Monitoring of the motor temperature (OH8)

Name	Signal			Source			Note
	Type	DIS	DIS format	CFG	List	Lenze	
T1/T2	-	-	-	-	-	-	-
MONIT-OH8	d	-	-	-	-	-	-

The monitoring is only executed if the motor temperature is detected with a PTC thermal sensor or thermal contact (NC contact) at the terminals T1, T2.

If the motor temperature exceeds the value that is firmly set in the controller, the monitoring responds.

The switch-off threshold and the hysteresis depend on the encoder system (DIN 44081).

Adjustable reactions	Error number LECOM
TRIP	0058
Warning	2058
Off	-

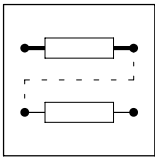

Configuration

Monitorings

2.5.17 Motor temperature monitoring with fixed threshold (OH3)



Fig. 2-154 Monitoring of the motor temperature, with fixed threshold (OH3)

Name	Signal			Source			Note
	Type	DIS	DIS format	CFG	List	Lenze	
TEMP-MOTOR	-	C0063	dec	-	-	-	-
MONIT-OH3	d	-	-	-	-	-	-

The monitoring is only executed when the motor temperature is detected with a KTY thermal sensor at X8.

Motor temperature monitoring and evaluation are only possible, if monitoring Sd6 is activated. In the Lenze setting, monitoring Sd6 is deactivated. (□ 2-181)

If the motor temperature exceeds the value that is firmly set in the controller, the monitoring responds.

The switch-off threshold is fixed and amounts to 150 °C. The hysteresis is also fixed and amounts to 15 K, i.e. the reclosing point is at 135 °C.

Adjustable reactions	Error number LECOM
TRIP	0053
Off	-

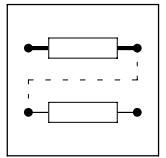

2.5.18 Motor temperature monitoring with adjustable threshold (OH7)



Fig. 2-155 Monitoring of the motor temperature, with adjustable threshold (OH7)

Name	Signal			Source			Note
	Type	DIS	DIS format	CFG	List	Lenze	
TEMP-MOTOR	-	C0063	dec	-	-	-	-
MONIT-OH7	d	-	-	-	-	-	-

The monitoring is only executed when the motor temperature is detected with a KTY thermal sensor at X8.

Motor temperature monitoring and evaluation are only possible, if monitoring Sd6 is activated. In the Lenze setting, monitoring Sd6 is deactivated. (☐ 2-181)

The monitoring is designed as an early warning before the controller is disconnected (OH3).

The process can be influenced in such a way that the motor will not be disconnected at a wrong time. For instance, fans can be activated which could lead to unacceptable noise developments during continuous operation.

The operating threshold can be set in C0121. The hysteresis is fixed and amounts to 15 K, i.e. the signal is cancelled at 15 K below the operating threshold.

Adjustable reactions	Error number LECOM
Warning	2057
Off	-

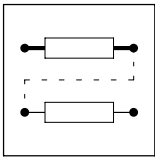

Configuration

Monitorings

2.5.19 Undervoltage monitoring in the DC bus (LU)

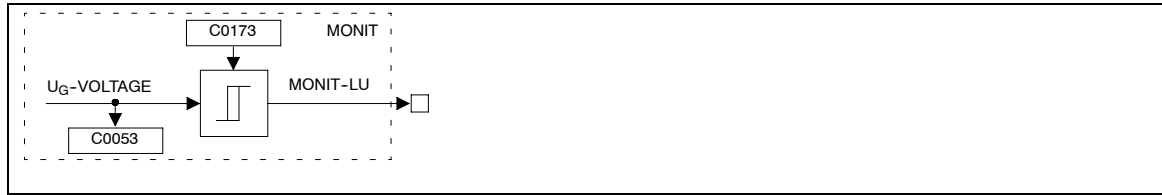

Fig. 2-156 Low voltage monitoring in the DC bus (LU)

Name	Signal			Source			Note
	Type	DIS	DIS format	CFG	List	Lenze	
U _G -VOLTAGE	-	C0053	dec	-	-	-	Cannot be reassigned
MONIT-LU	d	-	-	-	-	-	-

The monitoring responds if the DC-bus voltage (+U_G, -U_G) falls below the switch-off threshold LU which is set in C0173. The setting in C0173 is also valid for the overvoltage monitoring.

The message is reset if the switch-off threshold LU is exceeded again

The switch-off threshold LU determines the voltage level of the DC bus voltage, where the pulse inhibit is activated.

The code setting must be adapted to the existing mains voltage (also in case of DC supply). All controllers in a system must have the same setting.

If the message is pending more than three seconds or is it about mains connection, an entry in the history buffer is made. This may occur if the control module is supplied by an external voltage source via the terminals X5/39 and X5/59 and the mains is switched off.

If the signal is reset (mains is reconnected), the entry is not kept in the history buffer, but deleted (this is not a fault, but a controller state).

If the low voltage messages appear for less than three seconds, this is interpreted as a fault (e. g. mains error) and entered into the history buffer. In this case, the entry is kept in the history buffer.

Reaction	Error number LECOM
Message	1030

Configuration

Monitorings

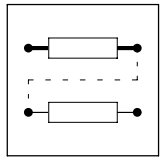

9300 vector	UG thresholds				
EVF9321 ... EVF9333	Mains voltage range		C0173	Switch-off threshold LU	Switch-on threshold LU
	< 400 V	Operation with/without brake chopper	0	285 V	430 V
	400 V	Operation with/without brake chopper	1 *	285 V	430 V
	460 V	Operation with/without brake chopper	2	328 V	473 V
	480 V	Operation without brake chopper	3	342 V	487 V
	480 V	Operation with brake chopper	4	342 V	487 V

9300 vector	UG thresholds				
EVF9335 ... EVF9383	Mains voltage range		C0173	Switch-off threshold LU	Switch-on threshold LU
	< 400 V	Operation with or without brake transistor	0	285 V	430 V
	400 V	Operation with or without brake transistor	1 *	285 V	430 V
	460 V	Operation with or without brake transistor	2	328 V	473 V
	480 V	Operation without brake transistor	3	342 V	487 V
	480 V	Operation with brake transistor	4	342 V	487 V
	500 V	Operation with or without brake transistor	5	342 V	487 V
EVF93xx-ExV210 EVF93xx-ExV240 EVF93xx-ExV270 EVF93xx-ExV300					
EVF93xx-Ex EVF93xx-ExV060 EVF93xx-ExV110	400 V	Operation with or without brake transistor	Only display	285 V	430 V

* Lenze setting

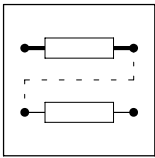

Configuration

Monitorings

2.5.20 Overvoltage monitoring in the DC bus (OU)

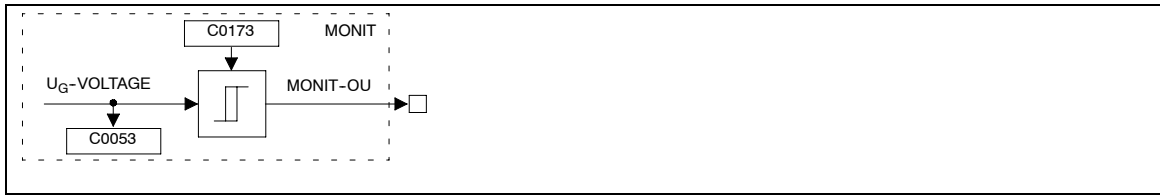

Fig. 2-157 Monitoring of overvoltage in the DC bus (OU)

Name	Signal			Source			Note
	Type	DIS	DIS format	CFG	List	Lenze	
U _G -VOLTAGE	-	C0053	dec	-	-	-	-
MONIT-OU	d	-	-	-	-	-	-

The monitoring responds if the DC-bus voltage (+U_G -U_G) exceeds the switch-off threshold OU which is set in C0173.

The message is reset if the voltage falls below the switch-off threshold OU again.

The switch-off threshold OU determines the voltage level of the DC bus voltage, where the pulse inhibit is activated.

The selection number is also effective for the low voltage monitoring (LU).

A frequent overvoltage message indicates an incorrect drive dimensioning. This means that the braking energy is too high.

If several controllers are operated at the same time, a DC supply may be sensible. In this way, the generated braking energy of one drive can be used as motive power for the other drives. Only the differential energy is absorbed via the mains connections.

Reaction	Error number LECOM
Message	1020

9300 vector	UG thresholds				
EVF9321 ... EVF9333	Mains voltage range		C0173	Switch-off threshold OU	Switch-on threshold OU
	< 400 V	Operation with/without brake chopper	0	770 V	755 V
	400 V	Operation with/without brake chopper	1 *	770 V	755 V
	460 V	Operation with/without brake chopper	2	770 V	755 V
	480 V	Operation without brake chopper	3	770 V	755 V
	480 V	Operation with brake chopper	4	800 V	785 V

9300 vector	UG thresholds				
EVF9335 ... EVF9383	Mains voltage range		C0173	Switch-off threshold OU	Switch-on threshold OU
	< 400 V	Operation with or without brake transistor	0	770 V	755 V
	400 V	Operation with or without brake transistor	1 *	770 V	755 V
	460 V	Operation with or without brake transistor	2	770 V	755 V
	480 V	Operation without brake transistor	3	770 V	755 V
	480 V	Operation with brake transistor	4	800 V	785 V
	500 V	Operation with or without brake transistor	5	900 V	885 V
EVF93xx-ExV210 EVF93xx-ExV240 EVF93xx-ExV270 EVF93xx-ExV300	400 V	Operation with or without brake transistor	Only display	700 V	685 V

* Lenze setting

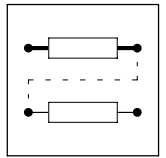

2.5.21 Monitoring for initialisation errors (PI)

Some parameters are used for internal calculation of further data. The monitoring starts if wrong values are detected as a result of this calculation.

A possible reason may be that e. g. the motor data are not suitable for the controller since parameters of a powerful controller have been transmitted to a less powerful controller.

Reaction	Error number LECOM
TRIP	0079

2.5.22 Monitoring for parameter set errors (PR0)



Danger!

If a parameter set error occurs, the Lenze setting is loaded automatically.

- After a TRIP reset the controller operates with the Lenze setting until a new setting is made.
- The Lenze setting is not stored.

The monitoring responds if the stored parameters are not suitable for the software version of the controller. In this case the Lenze setting is loaded automatically.

Correct the parameters and store all parameter sets with C0003.

The fault message can only be reset by mains switching.

Reaction	Error number LECOM
TRIP	0075

2.5.23 Monitoring for parameter set errors (PR1, PR2, PR3, PR4)



Danger!

If a parameter set error occurs, the Lenze setting is loaded automatically.

- After a TRIP reset the controller operates with the Lenze setting until a new setting is made.
- The Lenze setting is not stored.

Each parameter set is checked for correctness and completeness.

The monitoring responds if an error is detected while loading a parameter set. The faulty parameter set can be recognised by the fault message (PR1 = parameter set 1 ... PR4 = parameter set 4).

Reaction	Error number LECOM			
	PR1	PR2	PR3	PR4
TRIP	0072	0073	0077	0078

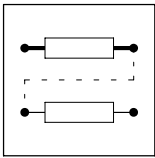

Configuration

Monitorings

2.5.24 Encoder monitoring at pin X9/8 (Sd3)

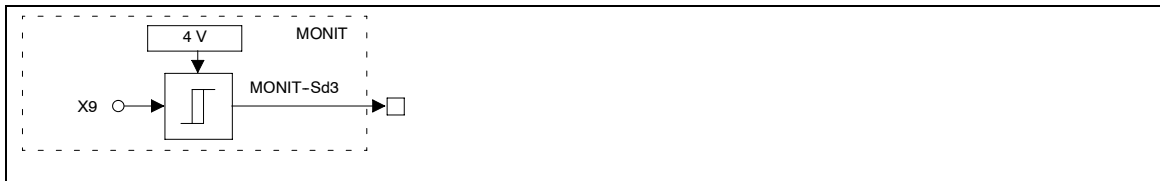

Fig. 2-158

Monitoring of the encoder at X9 (Sd3)

Name	Signal			Source			Note
	Type	DIS	DIS format	CFG	List	Lenze	
X10	-	-	-	-	-	-	-
MONIT-SD3	d	-	-	-	-	-	-

The monitoring responds if the pin X9/8 is not supplied with voltage. As a result, an interruption of the master frequency coupling is displayed.

Adjustable reactions	Error number LECOM
TRIP	0083
Warning	2083
Off	-

2.5.25 Encoder monitoring at X6/1, X6/2 (Sd5)



Fig. 2-159

Monitoring of the encoder at X6/1, X6/2 (Sd5)

Name	Signal			Source			Note
	Type	DIS	DIS format	CFG	List	Lenze	
i_{master}	-	-	-	-	-	-	-
MONIT-SD5	d	-	-	-	-	-	-

The monitoring responds if the current at the terminals X6/1, X6/2 falls below 2 mA. In order to be able to activate the monitoring function, the current range must be set to 4 ... 20 mA (C0034 = 1, jumper to X3).

Adjustable reactions	Error number LECOM
TRIP	0085
Warning	2085
Off	-

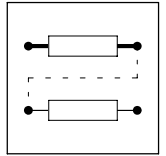

2.5.26 Sensor monitoring for the motor temperature detection (Sd6)

The monitoring is only executed when the motor temperature is detected with a KTY thermal sensor at X8. The monitoring is set under C0594. In the Lenze setting, the monitoring is deactivated (C0594 = 3).

The monitoring responds if a short-circuit or interruption is detected between the pins X8/5 and X8/8.

Adjustable reactions	Error number LECOM
TRIP	0086
Warning	2086
Off	–

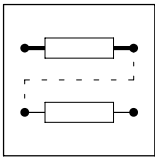

Configuration

Monitorings

2.5.27 Error message via digital output

You can assign the fault indications TRIP, message, and warning in the function block DIGOUT to digital outputs (e.g. the terminals X5/A1... X5/A4).

Display TRIP or Message or Warning individually (individual indication):

1. Select digital output in the code level under C0117 and subcode.
2. Assign TRIP or Message or Warning to the parameter level.

Display TRIP, Message, Warning collectively (collective indication):

1. Assign TRIP, Message and Warning to an OR element.
2. Select digital output in the code level under C0117 and subcode.
3. Assign output of the OR-element in the parameter level.

Display monitoring functions individually:

1. Select digital output in the code level under C0117 and subcode.
2. Assign monitoring function (e.g. MONIT-OH7).

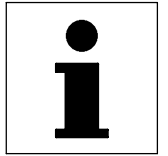

3 Application examples

Contents

3.1	Important notes	3-3
3.2	Accelerating and decelerating with constant time	3-4
3.3	Accelerating and decelerating with constant path	3-6
3.4	Dosing drive for a filling station	3-7
3.5	Traversing drive for a wire winder	3-9
3.6	Diameter detection with a distance sensor	3-13
3.7	Centre winder with internal diameter calculation	3-15

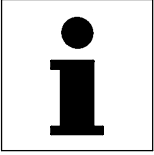

Application examples

Contents

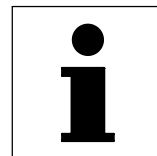

3.1 Important notes

For frequent applications, the controller-internal signal processing is stored in basic configurations.

- Under C0005, the basic configurations can be selected, activated, and, with a few settings, adapted to your application (Short Setup). (📖 2-6)
- The setting of the motor data and the adaptation of the motor control are usually independent of the configuration and described in the chapter "Commissioning".



Note!

In the "Short setup" menus of the "Global Drive Control" (GDC) operating/parameter setting software and the XT keypad, you can find the most important codes for the basic configurations.



Application examples

Accelerating and decelerating with constant time

3.2 Accelerating and decelerating with constant time

This application is based on the basic configuration C0005 = 1000.

Example

A conveyor drive used together with other drives shall accelerate and decelerate in a constant time. The setpoint for the conveying speed shall not influence the acceleration and deceleration time.

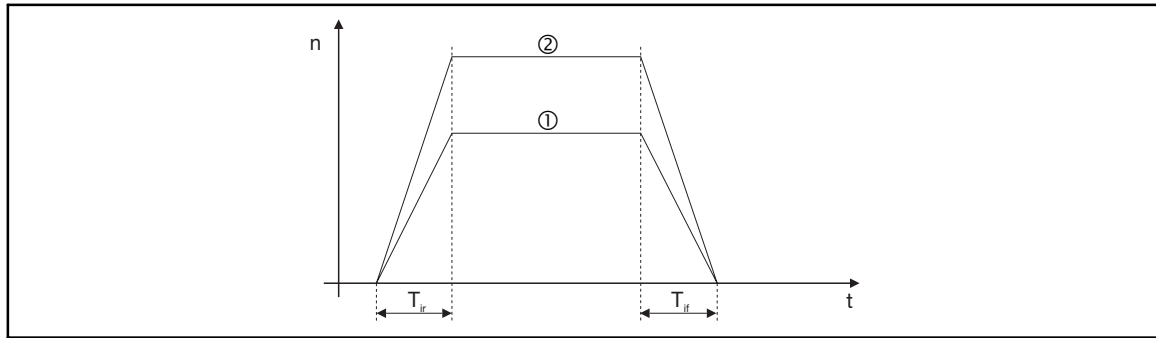

Fig. 3-1 Accelerating and decelerating with constant time (C0104 = 1)

- ① Setpoint 1
- ② Setpoint 2
- n Speed
- T_{ir} Acceleration time
- T_{if} Deceleration time



Solution

The drive is enabled and stopped via the inputs for the direction of rotation. The function of the digital inputs remains unchanged. The internal signal processing for quick stop (QSP) has been adapted accordingly.

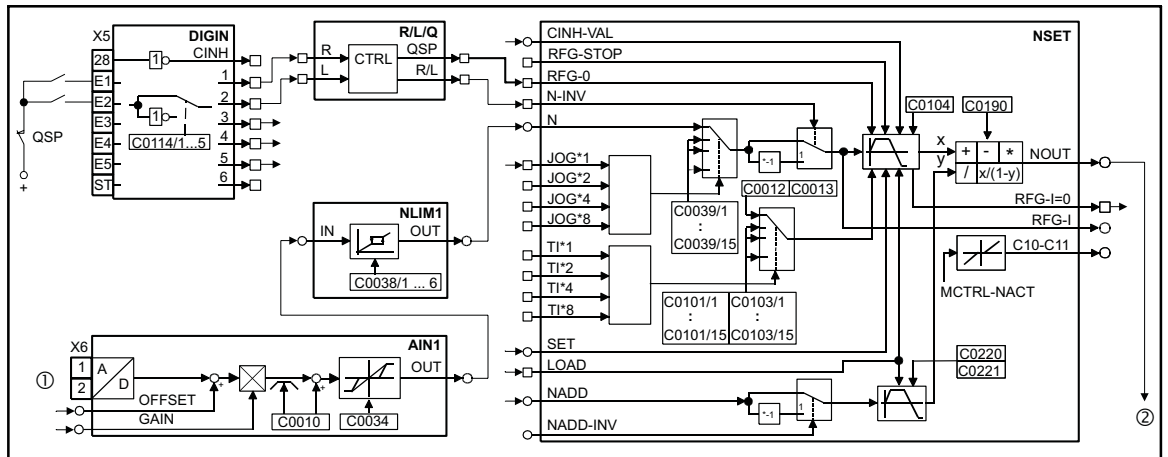

Fig. 3-2 Changes made in configuration 1000 for accelerating and decelerating in a constant time

- ① Setpoint
- ② Setpoint for input MCTRL-N-SET

Parameter setting

1. Remove the connection between the output R/LQ-QSP and the input MCTRL-QSP of the FB MCTRL.
2. Set MCTRL-QSP to FIXED0 (C0900 = 1000).
3. Connect the output R/L/Q-QSP with the input NSET-RFG-0 (C0789 = 10250).
4. Set C0104 = 1
 - The drive accelerates to the setpoint at X6/1,2 or decelerates to zero speed in a constant time.
5. Select the acceleration time (T_{ir}) under C0012 and the deceleration time (T_{if}) under C0013.



Tip!

If you want to use different acceleration and deceleration times, select the desired T_i time before or at the same time with the changeover of the setpoint at NSET-RFG-0.



Application examples

Accelerating and decelerating with constant path

3.3 Accelerating and decelerating with constant path

Use the basic configuration C0005 = 1000 with the changes shown in Fig. 3-2. However, set C0104 = 2.

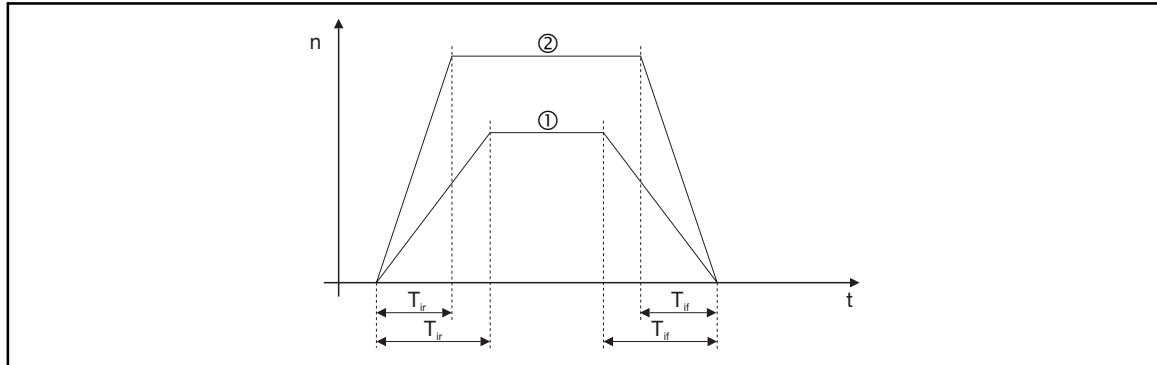

Fig. 3-3 Accelerating and decelerating with constant path (C0104 = 2)

- ① Setpoint 1
- ② Setpoint 2
- n Speed
- T_{ir} Acceleration time
- T_{if} Deceleration time

The distance is proportional to the number of motor revolutions. The distances are selected by setting the T_i times (C0012, C0013).

- The number of motor revolutions during acceleration or deceleration are calculated according to the following formula:

$$N = \frac{n_{\max}}{60} \cdot \frac{T_i}{2}$$

- N Number of motor revolutions
- n_{\max} Maximum speed (value in C0011)
- T_i Acceleration time T_{ir} (value in C0012) or deceleration time T_{if} (value in C0013)



3.4 Dosing drive for a filling station

This application is based on the basic configuration C0005 = 2000.

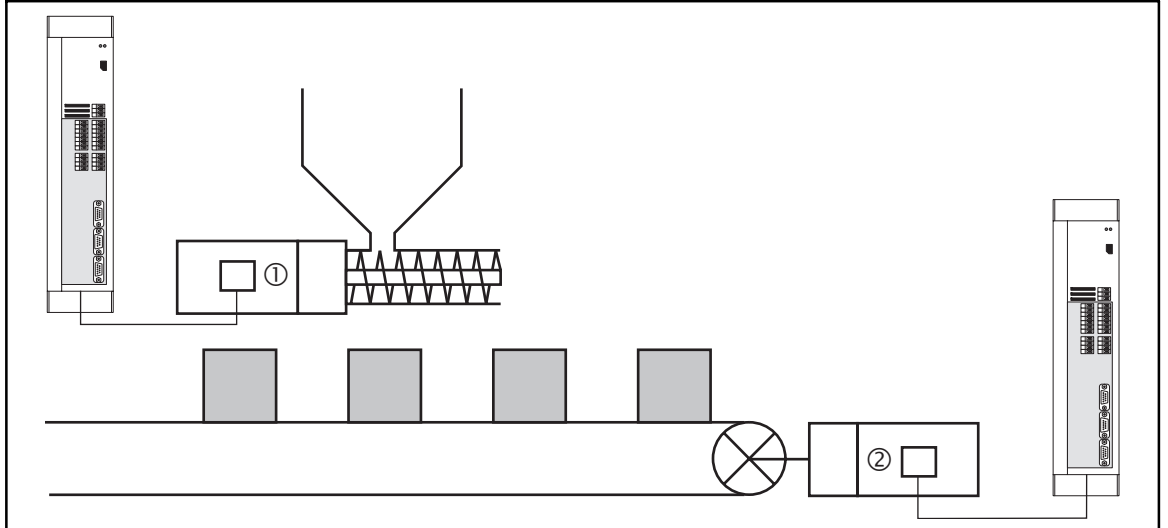

Fig. 3-4 Basic structure of a step controller for a bulk material filling station

- ① Dosing drive
- ② Conveyor drive

Input and output assignment		Dosing drive	Conveyor drive
Analog inputs	X6/1,2 X6/3,4	<ul style="list-style-type: none"> • Dosing speed • Dosing amount 	<ul style="list-style-type: none"> • Conveyor speed • Step width
Digital inputs	X5/28 X5/E1, X5/E2 X5/E3 X5/E4 X5/E5	<ul style="list-style-type: none"> • Controller enable • Direction of rotation/quick stop • Fixed dosing amount • Start dosing • TRIP reset 	<ul style="list-style-type: none"> • Controller enable • Step direction/quick stop • Fixed step width • Start step • TRIP reset
Digital outputs	X5/A1 X5/A2 X5/A3 X5/A4	<ul style="list-style-type: none"> • Error (TRIP) • Current speed > C0017 (Qmin) • Ready for operation (RDY) • Dosing completed 	<ul style="list-style-type: none"> • Error (TRIP) • Current speed > C0017 (Qmin) • Ready for operation (RDY) • Step completed
Analog outputs	X6/62 X6/63	<ul style="list-style-type: none"> • Actual speed • Motor current 	<ul style="list-style-type: none"> • Actual speed • Motor current



Tip!

If the required amount has not yet been reached at the end of dosing, you can control redosing via the setpoint.



Application examples

Dosing drive for a filling station

Calculating the actual value

- Use the FB INT1 to add the motor speed to an angle of rotation. The dosing amount can be calculated via the angle of rotation.
 - An angle of rotation of 360 ° (one revolution) corresponds to 65536 inc.
- Via C1351, the angle of rotation is converted into an analog signal and adapted to the setpoint.

Example

With a setpoint of INT1-AOUT = 100 %, the conveyor worm shall make 50 revolutions. The geared motor has a ratio of $I = 20$.

- The motor must make 1000 revolutions.
 - The angle of rotation is 65536 inc · 1000.
- Select 65536000 under C1351.
- The following formula is used for the calculation:

$$\text{INT1-AOUT} = \frac{\text{Drehwinkel [inc]}}{\text{C1351}} \cdot 100 \%$$

See also: (□ 2-111)

Completing dosing

The FB CMP2 sends the brake signal for the linear ramp function generator in the FB NSET. The ramp function generator is controlled via NSET-RFG-0 and thus led to the zero speed setpoint.

Deceleration is activated if the actual amount plus the remaining amount (this amount is added during deceleration) corresponds to the setpoint.

Considering the remaining amount

- Use the FB ARIT1 to square the current speed ($C0338 = 3$).
- Use the FB CONV1 to adapt the output signal of ARIT1 under consideration of the deceleration time T_{if} to the setpoint and actual value. The following formula is used to calculate the C0940/C0941 ratio:

$\frac{C0940}{C0941} = \frac{n_{\max}}{60} \cdot \frac{T_{if}}{2} \cdot \frac{65536}{C1351}$	$\frac{n_{\max}}{T_{if}}$	Value in C0011 Deceleration time (value in C0013)
--	---------------------------	--

Example

- $n_{\max} = 3000$ rpm
- $T_{if} = 1$ s
- $C1351 = 65536000$ (corresponds to 1000 motor revolutions)

The C0940/C0941 ratio must be 0.025 (e.g. C0940 = 25; C0941 = 1000).



3.5 Traversing drive for a wire winder

This application is based on the basic configuration C0005 = 3000.

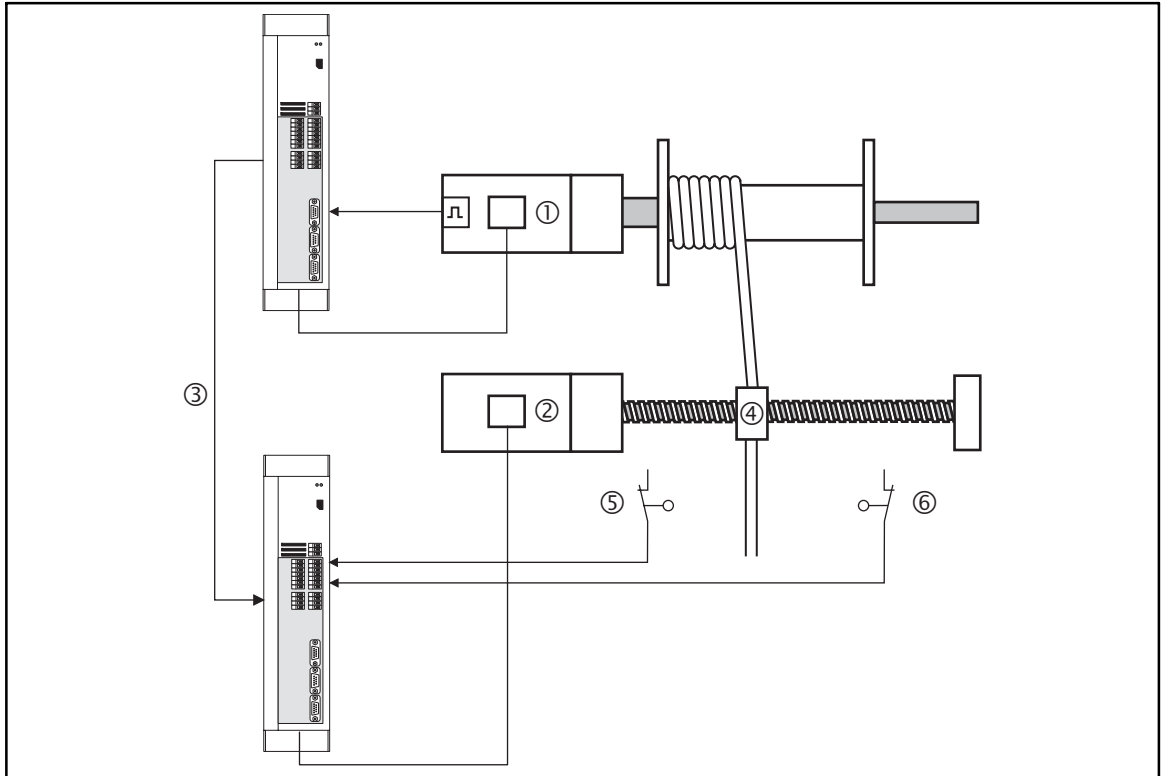

Fig. 3-5 Basic structure of a traversing controller

- | | | | |
|---|------------------------------------|---|---|
| ① | Winding drive | ④ | Traversing unit |
| ② | Traversing drive | ⑤ | Limit switch for changeover to CCW rotation |
| ③ | Reference setpoint (winding drive) | ⑥ | Limit switch for changeover to CW rotation |

Input and output assignment		Traversing drive
Analog input	X6/1,s	<ul style="list-style-type: none"> Reference setpoint
Digital inputs	X5/28 X5/E1, X5/E2 X5/E3 X5/E4 X5/E5	<ul style="list-style-type: none"> Controller enable Direction of rotation/quick stop Additional setpoint Start traversing TRIP reset
Digital outputs	X5/A1 X5/A2 X5/A3 X5/A4	<ul style="list-style-type: none"> Error (TRIP) Current speed > C0017 (Q_{min}) Ready for operation (RDY) Traversing break
Analog outputs	X6/62 X6/63	<ul style="list-style-type: none"> Actual speed Motor current



Application examples

Traversing for a wire winder

The traversing speed results from the precontrol signal proportional to the winding speed and the evaluation setting (traversing step). Limit switches detect the position of the traversing unit at the reel ends. The traversing drive is decelerated and accelerated with a constant path and independently of the winding speed.

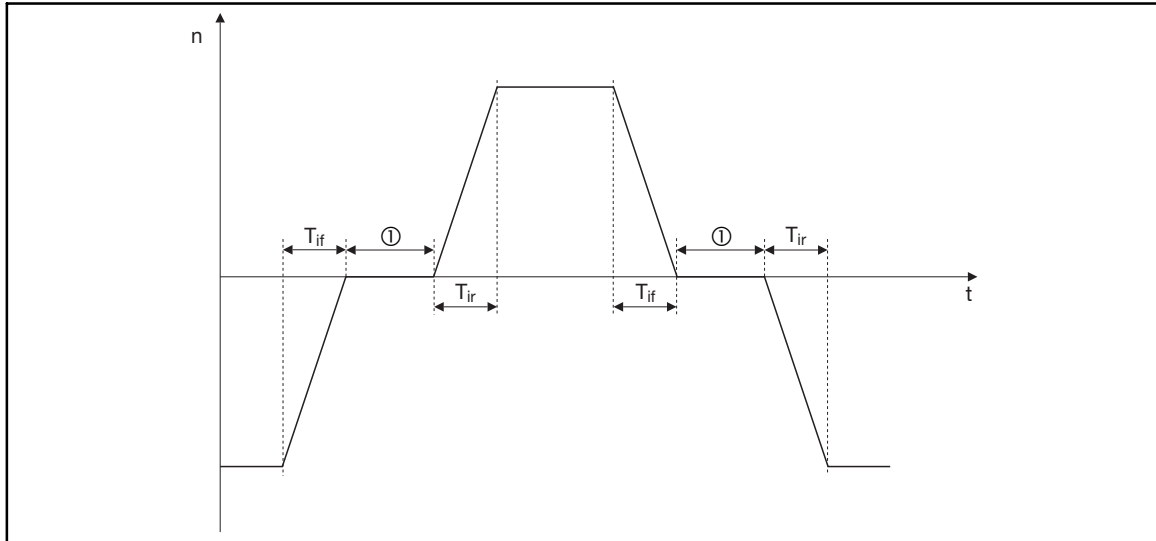

Fig. 3-6 Decelerating and accelerating the traversing drive with traversing break

① Traversing break
n Speed
 T_{ir} Acceleration time
 T_{if} Deceleration time

At the turning points, the traversing drive remains at standstill until the winding drive has traversed a specified angle of rotation.

Traversing step

For the traversing speed and the traversing step, the reference setpoint (winding speed via X6/1,2) is multiplied by C0472/1.

With a reference setpoint of 10 V and an evaluation of C0472/1 = 100 %, the traversing drive reaches the speed selected under C0011 (n_{max}).

Additional setpoint

Via X5/E3 you can activate an internal additional setpoint (C0471) which is added to the reference setpoint via the FB ADD1. The additional setpoint can, for instance, be used to adjust the traversing drive while the winding drive is at standstill.



Remaining path during deceleration and acceleration

The linear ramp function generator in the FB NSET (controlled via the input NSET-RFG-0) decelerates and accelerates the traversing drive.

Functional sequence

1. If the traversing unit reaches a limit switch (NC contact), the FB R/L/Q detects a change of direction of rotation.
2. The D-flipflop FLIP1 is set via the FB TRANS1.
3. The input NSET-RFG-0 is activated via the FB OR1 and deceleration starts.
4. When the ramp function generator has been decelerated to zero (NSET-NOOUT = 0), the FB CMP2 enables the calculation of the angle of rotation for the traversing break.
5. When the traversing break is over, the D-flipflop FLIP1 is reset via the FB INT1 (INT1-DOOUT = HIGH).
6. The traversing drive starts with a new direction of rotation.



Tip!

When the basic configuration C0005 = 3000 is loaded for this application, the ramp function generator is default-set to traversing drive deceleration and acceleration with constant path (C0104 = 2) and independently of the winding speed.

Determining the distance traversed during deceleration and acceleration

The distance traversed during deceleration and acceleration corresponds to a certain number of motor revolutions (N). The number N is determined by setting the Ti-times (C0012, C0013).

- The number of motor revolutions during deceleration or acceleration are calculated according to the following formula:

$$N = \frac{n_{\max}}{60} \cdot \frac{T_i}{2}$$

N	Number of motor revolutions
n_{\max}	Maximum speed (value in C0011)
T_i	Acceleration time T_{ir} (value in C0012) or deceleration time T_{if} (value in C0013)



Application examples

Traversing for a wire winder

Traversing break

Via X6/1,2, the controller of the traversing drive receives a normalised reference setpoint from the controller of the winding drive. For determining the angle of rotation which the winding drive is to traverse during the traversing break, calculate the speed signal of the winding drive via the FB CONV5. CONV5 is parameterised under C0655 and C0656.

- The following formula is used to calculate the C0655/C0656 ratio:

$$\frac{C0655}{C0656} = \frac{\text{max. Wickeldrehzahl [rpm]} \cdot 100 \%}{\text{max. Führungssollwert [\%]} \cdot 15000 \text{ rpm}}$$

Example

- Max. winding speed = 1000 rpm
- Max. reference setpoint = 100 % (at max. winding speed)

The C0655/C0656 ratio must be 0.0666 (e.g. C0655 = 1000; C0656 = 15000).

Selecting the angle of rotation for the winding drive during the traversing break

An angle of rotation of 360 ° (one revolution) corresponds to 65536 inc. The following formula is used to calculate the value for C0474/1:

$$C0474/1 = 65536 \cdot \frac{\text{Drehwinkel}}{360^\circ}$$

For a traversing break of half a revolution of the winding drive, 32768 must be entered under C0474/1.



Tip!

When C0474/1 = 0 is selected, the traversing drive decelerates and starts with constant acceleration.



3.6 Diameter detection with a distance sensor

This application is based on the basic configuration C0005 = 8000.

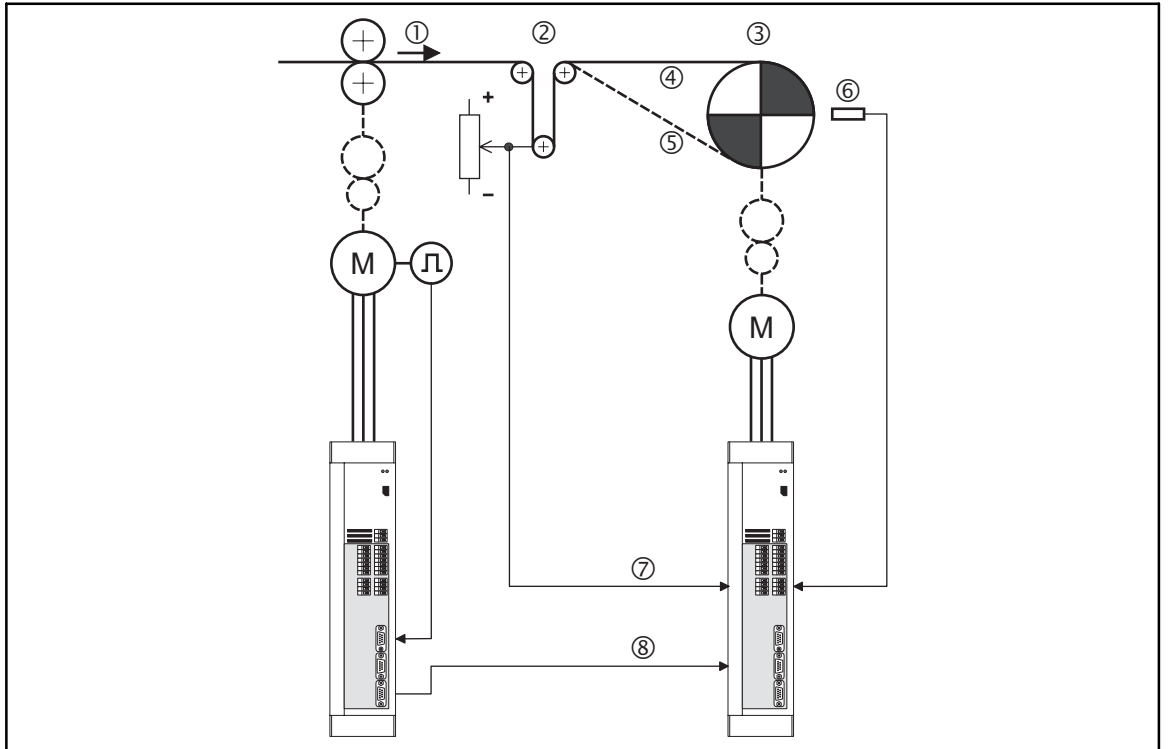

Fig. 3-7 Basic structure of a dancer position control with external diameter detection via a distance sensor

- ① Line speed (material speed)
- ② Dancer
- ③ Winder
- ④ Material guide for CW rotation of the winder
- ⑤ Material guide for CCW rotation of the winder
- ⑥ Distance sensor (detects the distance to the winding surface)
- ⑦ Actual dancer position
- ⑧ Digital frequency of material speed

Input and output assignment		Winding drive
Digital frequency input	X9	<ul style="list-style-type: none"> • Line speed (material speed)
Analog input	X6/1,2 X6/3,4	<ul style="list-style-type: none"> • Actual dancer position • Signal from distance sensor
Digital inputs	X5/28 X5/E1, X5/E2 X5/E3 X5/E4 X5/E5	<ul style="list-style-type: none"> • Controller enable • Direction of rotation/quick stop • Loading the actual value • Reset of dancer position controller • TRIP reset
Digital outputs	X5/A1 X5/A2 X5/A3 X5/A4	<ul style="list-style-type: none"> • Error (TRIP) • Actual dancer position = setpoint • Ready for operation (RDY) • D_{min}/D_{max} reached
Analog outputs	X6/62 X6/63	<ul style="list-style-type: none"> • Actual speed • Motor current

The analog input X6/3,4 (AIN2) is assigned with the signal of the diameter detection. If a distance sensor is used to detect the reel diameter, gain and offset of the FB AIN2 can be selected in a way that the diameter signal will be directly generated from the sensor signal.



Application examples

Diameter detection with a distance sensor

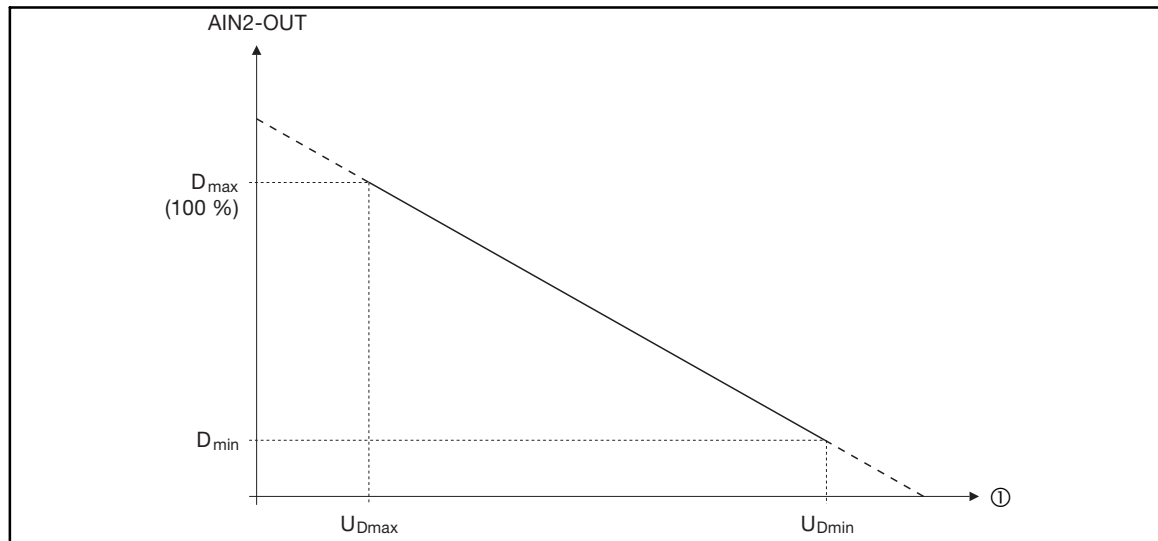

Fig. 3-8

Transfer characteristic of X6/3,4 when using a distance sensor

D_{\max}	Maximum reel diameter	$V_{D\max}$	Signal voltage of the sensor with maximum reel diameter
D_{\min}	Minimum reel diameter	$V_{D\min}$	Signal voltage of the sensor with minimum reel diameter
		①	Sensor signal

With maximum reel diameter, the signal at AIN2-OUT must be 100 %. This is why the FB AIN2 must receive the inverse transfer characteristic shown in Fig. 3-8.

The following formulas are used to calculate the values for gain (C0027/2) and offset (C0026/2):

$$C0027/2 = \frac{10 \text{ V}}{D_{\max}} \cdot \frac{D_{\max} - D_{\min}}{U_{D\max} - U_{D\min}}$$

$$C0026/2 = C0027/2 \cdot \frac{U_{D\max}}{10 \text{ V}} - 100 \%$$

Example

$$V_{D\min} = 8 \text{ V}, D_{\min} = 100 \text{ mm}$$

$$V_{D\max} = 2 \text{ V}, D_{\max} = 500 \text{ mm}$$

Enter the following values under C0027/2 and C0026/2:

$$C0027/2 = \frac{10 \text{ V}}{500 \text{ mm}} \cdot \frac{500 \text{ mm} - 100 \text{ mm}}{2 \text{ V} - 8 \text{ V}} = -133.33 \%$$

$$C0026/2 = -133.33 \% \cdot \frac{2 \text{ V}}{10 \text{ V}} - 100 \% = -126.67 \%$$



Tip!

For more detailed information on parameter setting, please see the application example for the basic configuration C0005 = 9000. (3-15)

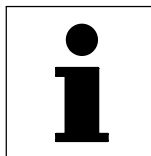

3.7 Centre winder with internal diameter calculation

This application is based on the basic configuration C0005 = 9000.

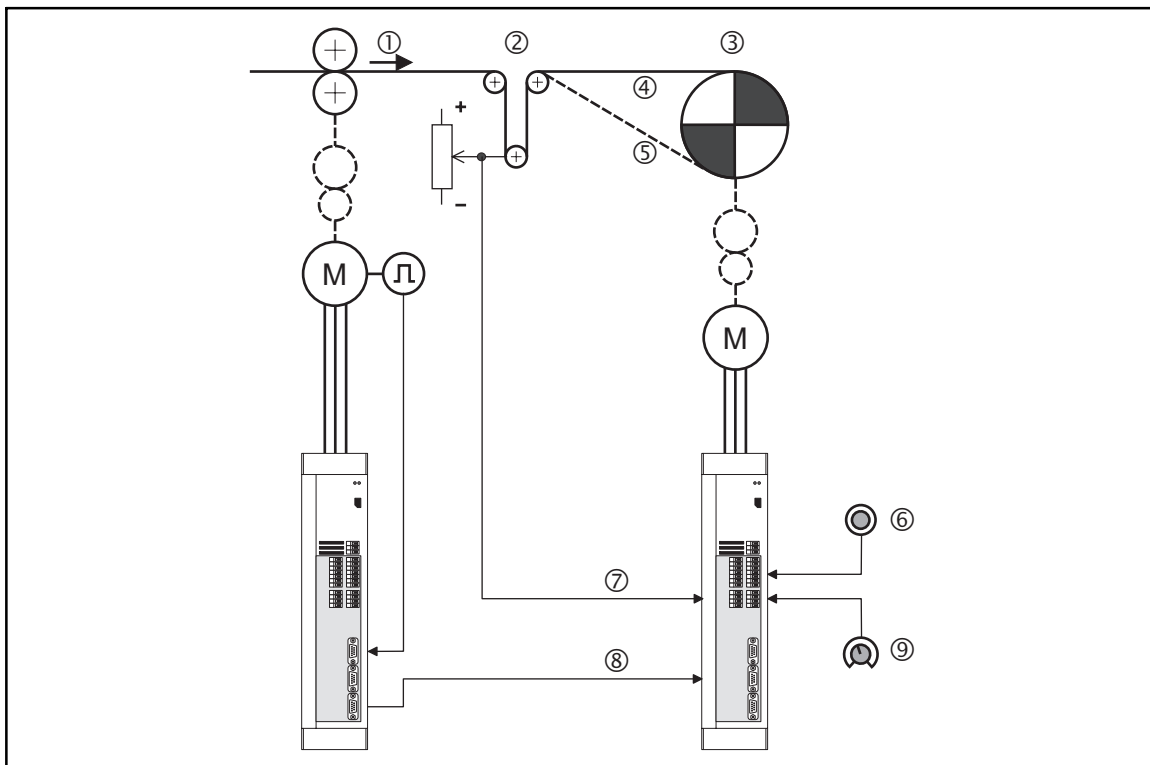

Fig. 3-9 Basic structure of a dancer position control with internal diameter detection

- | | |
|---|--|
| ① Line speed | ⑥ Preset diameter |
| ② Dancer | ⑦ Actual dancer position |
| ③ Winder | ⑧ Digital frequency proportional to the line speed |
| ④ Material guide for CW rotation of the winder | ⑨ Initial diameter |
| ⑤ Material guide for CCW rotation of the winder | |

Input and output assignment		Winding drive
Digital frequency input	X9	<ul style="list-style-type: none"> Line speed
Analog input	X6/1,2 X6/3,4	<ul style="list-style-type: none"> Actual dancer position Initial diameter
Digital inputs	X5/28 X5/E1, X5/E2 X5/E3 X5/E4 X5/E5	<ul style="list-style-type: none"> Controller enable Direction of rotation/quick stop Loading the actual value Accepting the initial diameter TRIP reset
Digital outputs	X5/A1 X5/A2 X5/A3 X5/A4	<ul style="list-style-type: none"> Error (TRIP) Actual dancer position = setpoint Ready for operation (RDY) D_{min}/D_{max} reached
Analog outputs	X6/62 X6/63	<ul style="list-style-type: none"> Actual speed Motor current



Application examples

Centre winder with internal diameter calculation

The following values are required for parameter setting:

- Rated line speed (V_{LN}) selected via the digital frequency input X9.
- Winding drive speed with rated line speed and minimum reel diameter (n_{Dmin}).
 - The winding drive speed results from the line speed V_L and the reciprocal of the reel diameter:

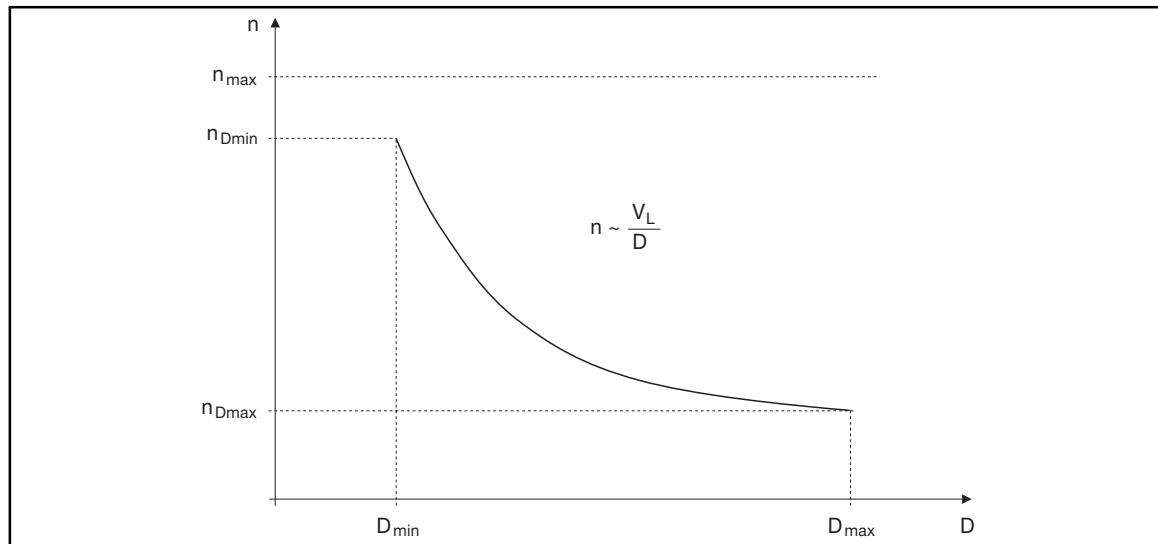

Fig. 3-10

Speed behaviour of the winding drive with reference to the reel diameter

d	Reel diameter	n	Winding drive speed
D_{max}	Maximum reel diameter	n_{Dmax}	Winding drive speed with maximum reel diameter
D_{min}	Minimum reel diameter	n_{Dmin}	Winding drive speed with minimum reel diameter
		V_L	Line speed

Example

For a clearer representation of the parameter setting in this application example, the following values are assumed for the calculations:

- At rated line speed (V_{LN}) the winding drive receives a digital frequency signal from which a speed of 3000 rpm is calculated (DFIN-OUT).
- The winding drive speed with minimum reel diameter and rated line speed V_{LN} (n_{Dmin}) is 4000 rpm (MCTRL-PHI-ACT).



Determining the maximum speed n_{\max} (C0011)

Through the influence of the dancer position controller (C0472/1) the drive may for a short time reach a higher speed than $n_{D_{\min}N}$. The higher speed is, for instance, required to reach the setpoint dancer position after starting with D_{\min} .

$$C0011 \geq n_{D_{\min}N} \cdot \left(\frac{100 \%}{100 \% - C0472/1} \right)$$

Example:

With $C0472/1 = 10 \%$ (Lenze setting) and $n_{D_{\min}N} = 4000$ rpm, C0011 must be set to, for instance, 4500 rpm.

Adapting the precontrol signal

The FB CONV3 is used to convert the speed signal proportional to the line speed (signal at DFIN-OUT) into a normalised (analog) precontrol signal.

It is assumed that during steady operation the speed setpoint is only generated by the precontrol signal and with minimum diameter sent to the motor control without being changed (diameter evaluation = 100 %). Accordingly, the following formula is to be used to calculate the line speed (speed at DFIN-OUT) for steady operation with rated line speed and minimum reel diameter:

$$\text{CONV3-OUT} = \frac{n_{D_{\min}N}}{C0011}$$

For the parameterisation of the FB CONV3 this means accordingly:

$$\frac{C0950}{C0951} = \frac{15000 \text{ rpm}}{\text{DFIN-OUT [rpm]}} \cdot \frac{n_{D_{\min}N}}{C0011}$$

Example:

$$\frac{C0950}{C0951} = \frac{15000 \text{ rpm}}{3000 \text{ rpm}} \cdot \frac{4000 \text{ rpm}}{4500 \text{ rpm}} = 4.444$$

E.g.: C0950 = 4444, C0951 = 1000



Application examples

Centre winder with internal diameter calculation

Diameter evaluation

The FB ARIT1 is used to multiply the precontrol signal by the reciprocal of the reel diameter.

The diameter calculator (DCALC1) calculates the reel diameter from the line speed (speed at DFIN-OUT) and the motor speed and then calculates the reciprocal (C1308 = 1).

For a correct diameter calculation, enter the following values:

- Under C1300: Motor speed with maximum diameter
- Under C1301: Corresponding line speed (speed at DFIN-OUT)
- Under C1304: Maximum diameter
- Under C1309: Reference diameter for the calculation of the reciprocal

Example:

With a diameter ratio $q = 5$ (e.g. $D_{\min} = 100$ mm, $D_{\max} = 500$ mm), this means in this case:

- C1300 = 3000 rpm
- $C1301 = \frac{n_{D_{\min}N}}{q} = 800$ rpm
- C1304 = 500 mm
- C1309 = 100 mm (enter the value used as a basis for determining $n_{D_{\min}N}$)

Limit values for the reel diameter

Under C1305 and C1306 you can select limit values to limit incorrect diameter values during the start and stop phases to permissible values.

Example:

- C1305 = 100 mm
- C1306 = 500 mm

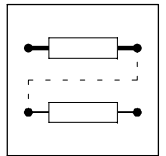

4 Signal-flow charts

Contents

4.1	How to read the signal-flow charts	4-3
4.2	Speed control (C0005 = 1000)	4-4
4.2.1	Speed control with brake output (C0005 = 1100)	4-6
4.2.2	Speed control with motor potentiometer (C0005 = 1200)	4-8
4.2.3	Speed control with process controller (C0005 = 1300)	4-10
4.2.4	Speed control with mains failure control (C0005 = 1400)	4-12
4.2.5	Speed control with digital frequency input (C0005 = 1500)	4-14
4.3	Step control (C0005 = 2000)	4-16
4.4	Traversing control (C0005 = 3000)	4-18
4.5	Torque control (C0005 = 4000)	4-20
4.6	Digital frequency master (C0005 = 5000)	4-22
4.7	Digital frequency bus (C0005 = 6000)	4-24
4.8	Digital frequency cascade (C0005 = 7000)	4-26
4.9	Dancer position control (external diameter calculator) (C0005 = 8000)	4-28
4.10	Dancer position control (internal diameter calculator) (C0005 = 9000)	4-30

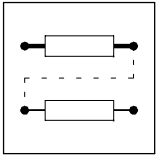

Signal-flow charts

Contents

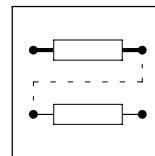

4.1 How to read the signal-flow charts

Symbol	Meaning
	Signal connection in the Lenze setting
	Analog input, can be freely connected to any analog output
	Analog output
	Digital input, can be freely connected to any digital output
	Digital output
	Input for speed signals, can be freely connected to any output for speed signals
	Output for speed signals
	Input for phase signals, can be freely connected to any output for phase signals
	Output for phase signals

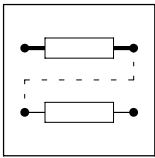

Signal-flow charts

Speed control

4.2 Speed control (C0005 = 1000)

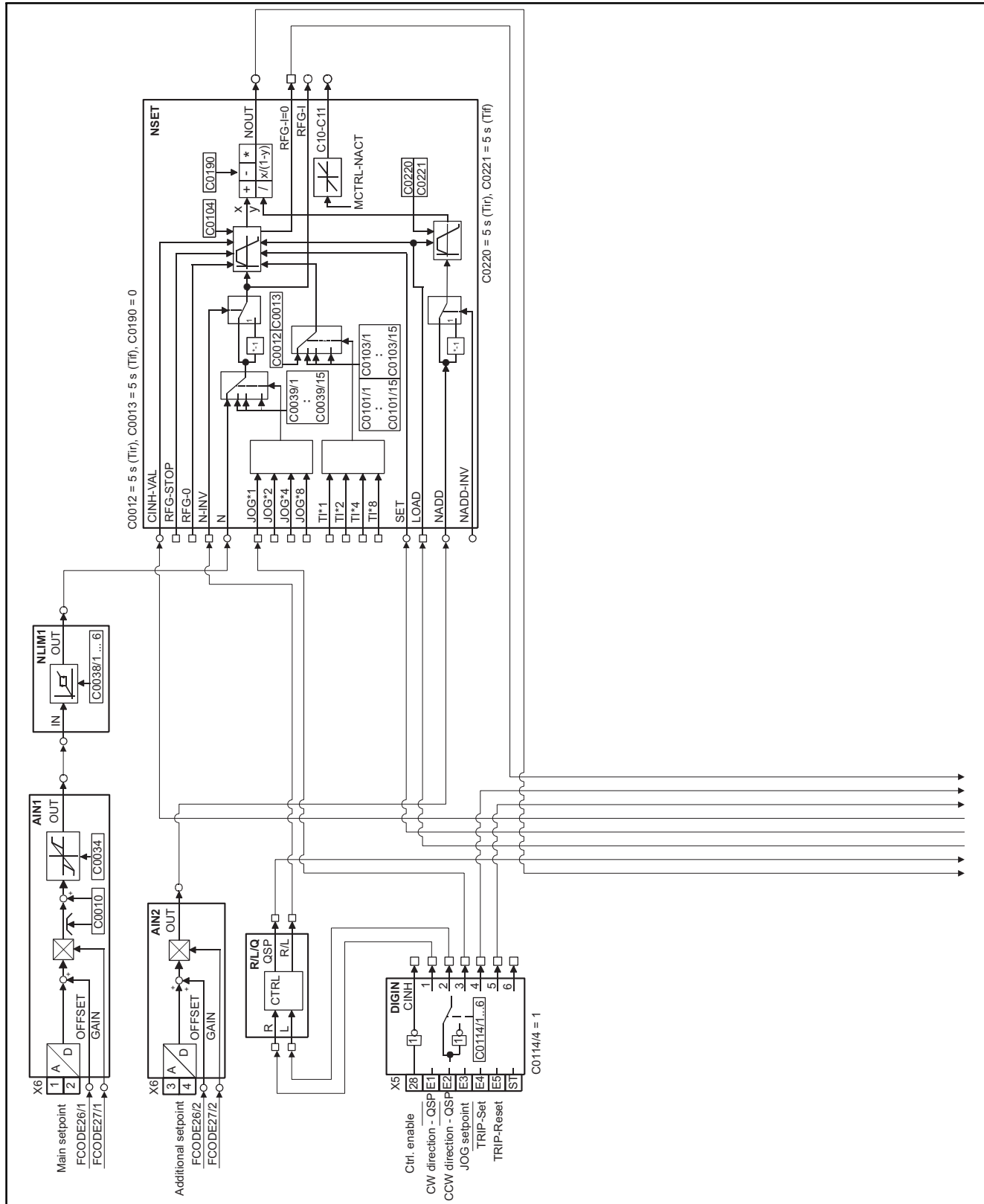

Fig. 4-1 Basic configuration 1000 - speed control (sheet 1)

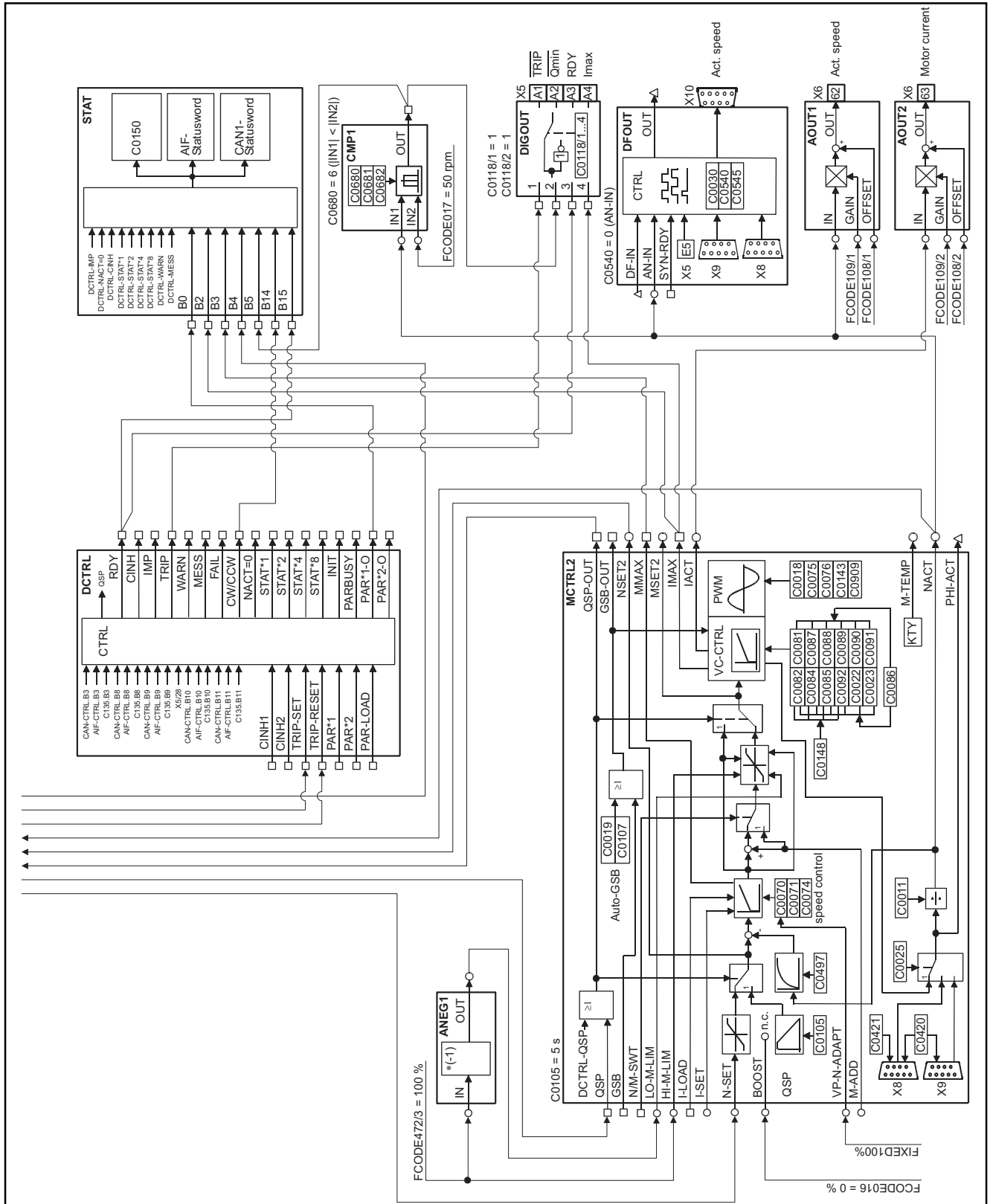
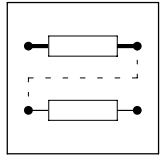
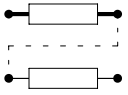

Fig. 4-2 Basic configuration 1000 - speed control (sheet 2)



Signal-flow charts

Speed control

4.2.1 Speed control with brake output (C0005 = 1100)

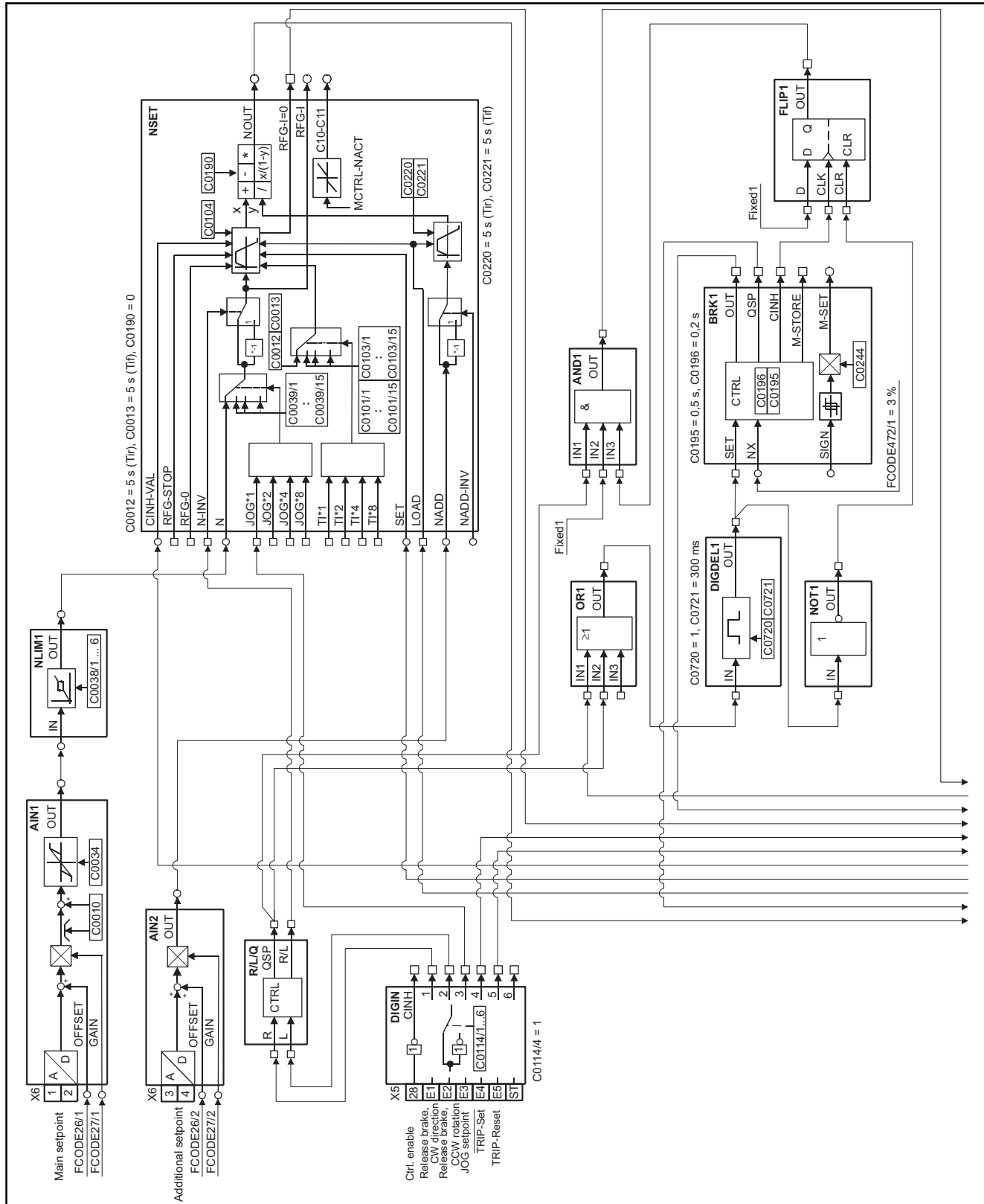

Fig. 4-3 Basic configuration 1100 - speed control with brake output (sheet 1)

Signal-flow charts

Speed control

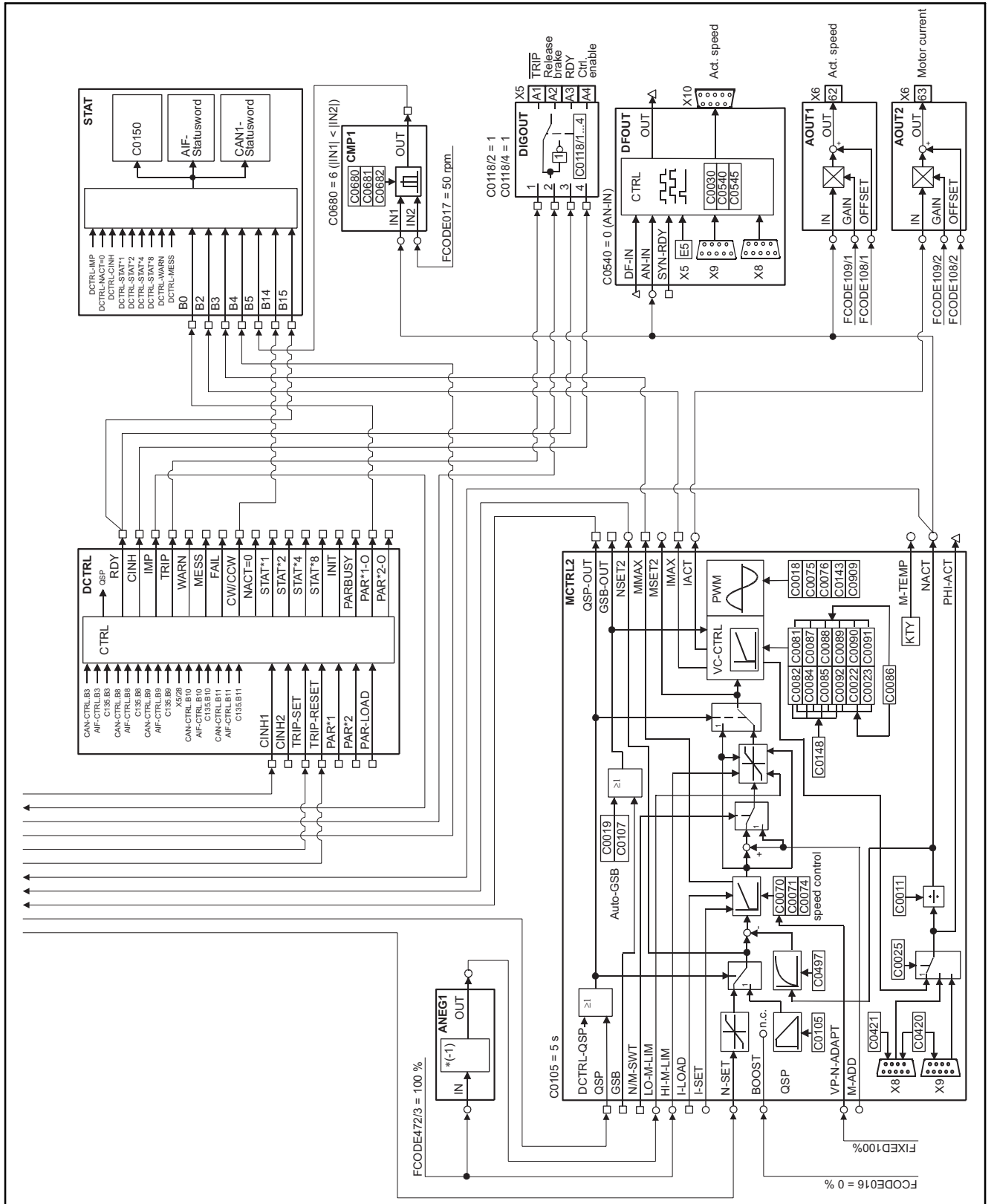
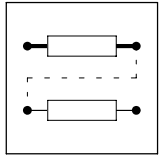
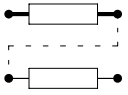

Fig. 4-4 Basic configuration 1100 - speed control with brake output (sheet 2)



Signal-flow charts

Speed control

4.2.2 Speed control with motor potentiometer (C0005 = 1200)

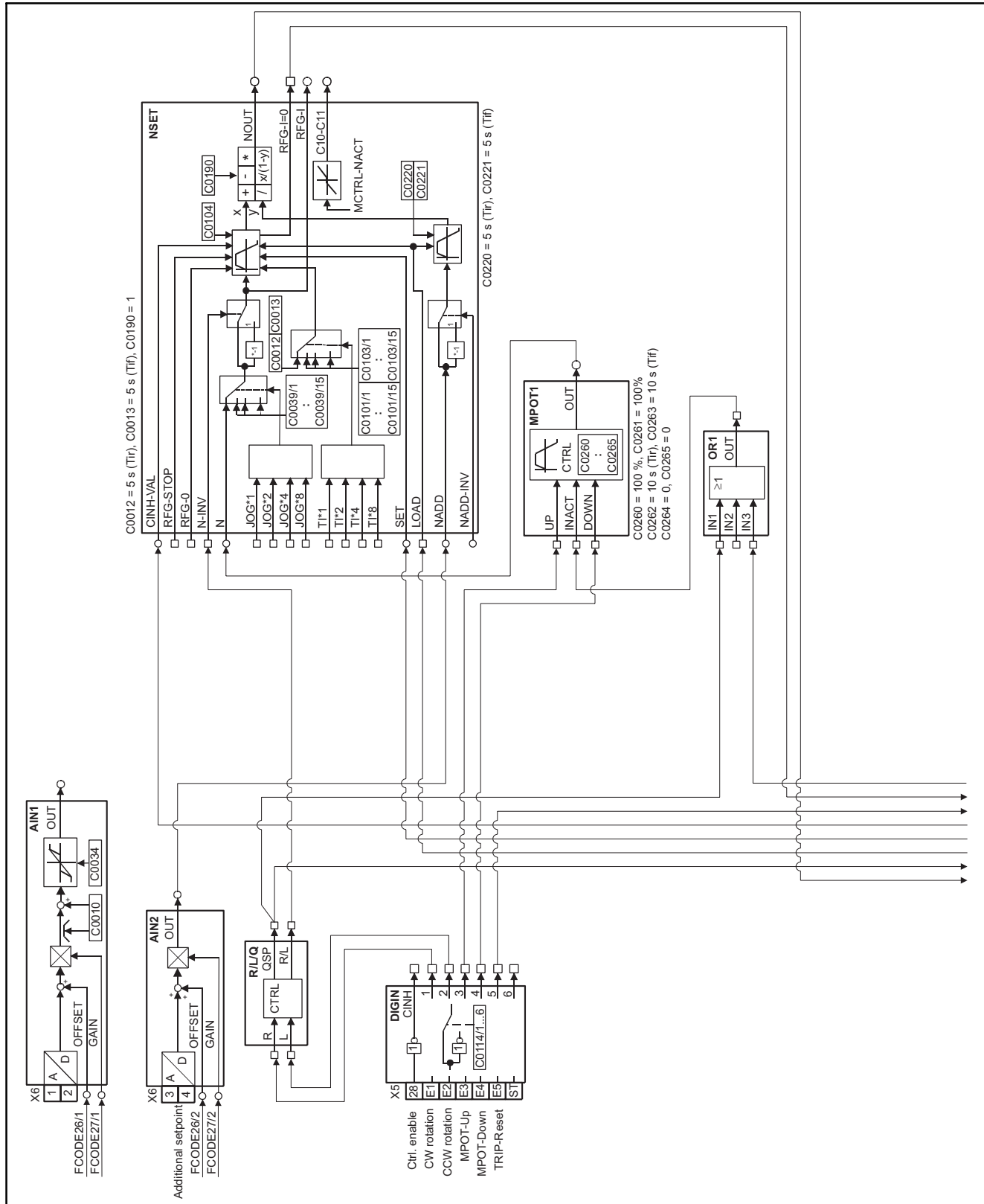

Fig. 4-5 Basic configuration 1200 - speed control with motor potentiometer (sheet 1)

Signal-flow charts

Speed control

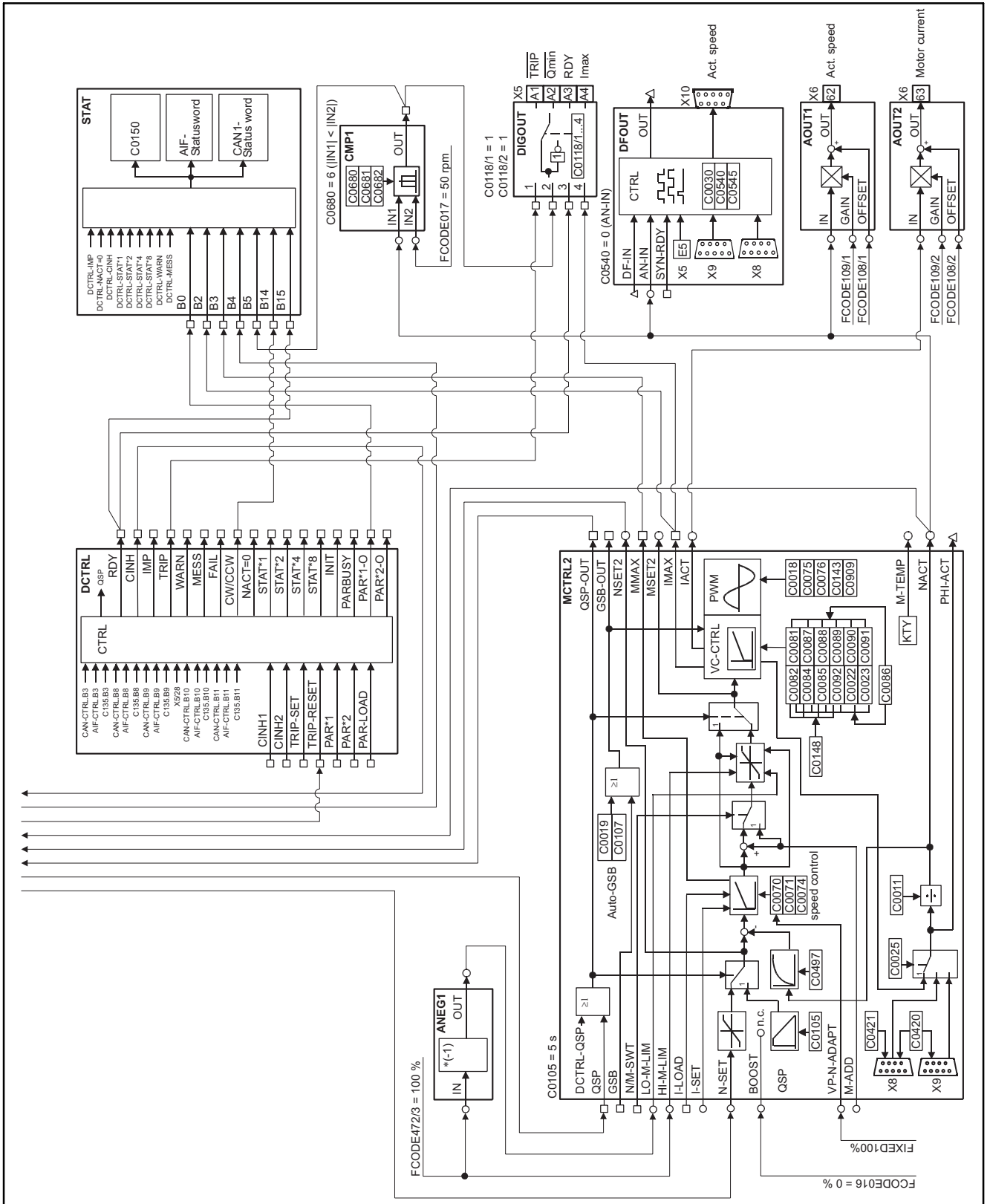
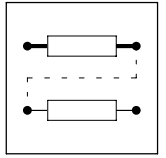
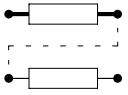

Fig. 4-6 Basic configuration 1200 - speed control with motor potentiometer (sheet 2)



Signal-flow charts

Speed control

4.2.3 Speed control with process controller (C0005 = 1300)

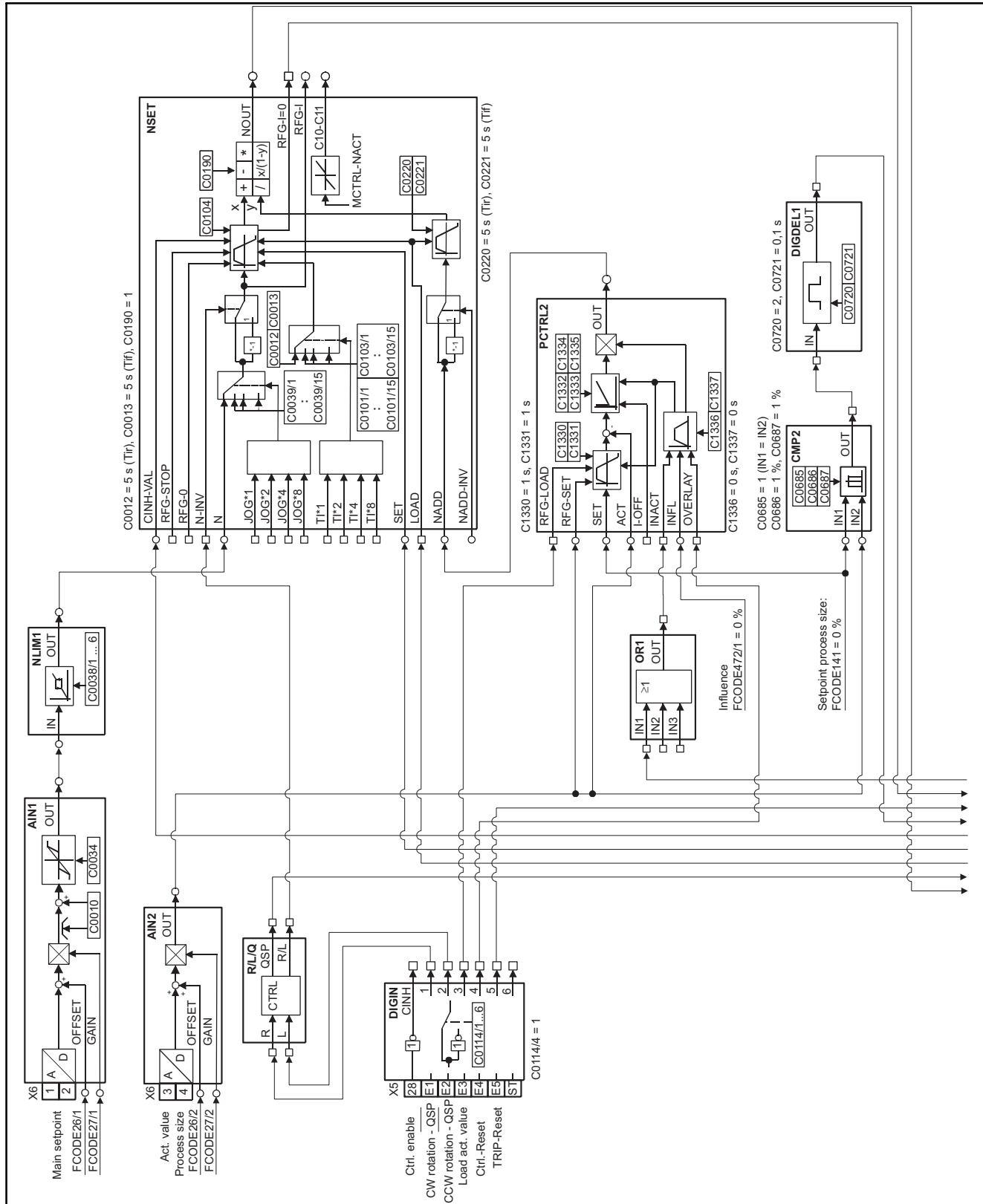

Fig. 4-7 Basic configuration 1300 - speed control with process controller (sheet 1)

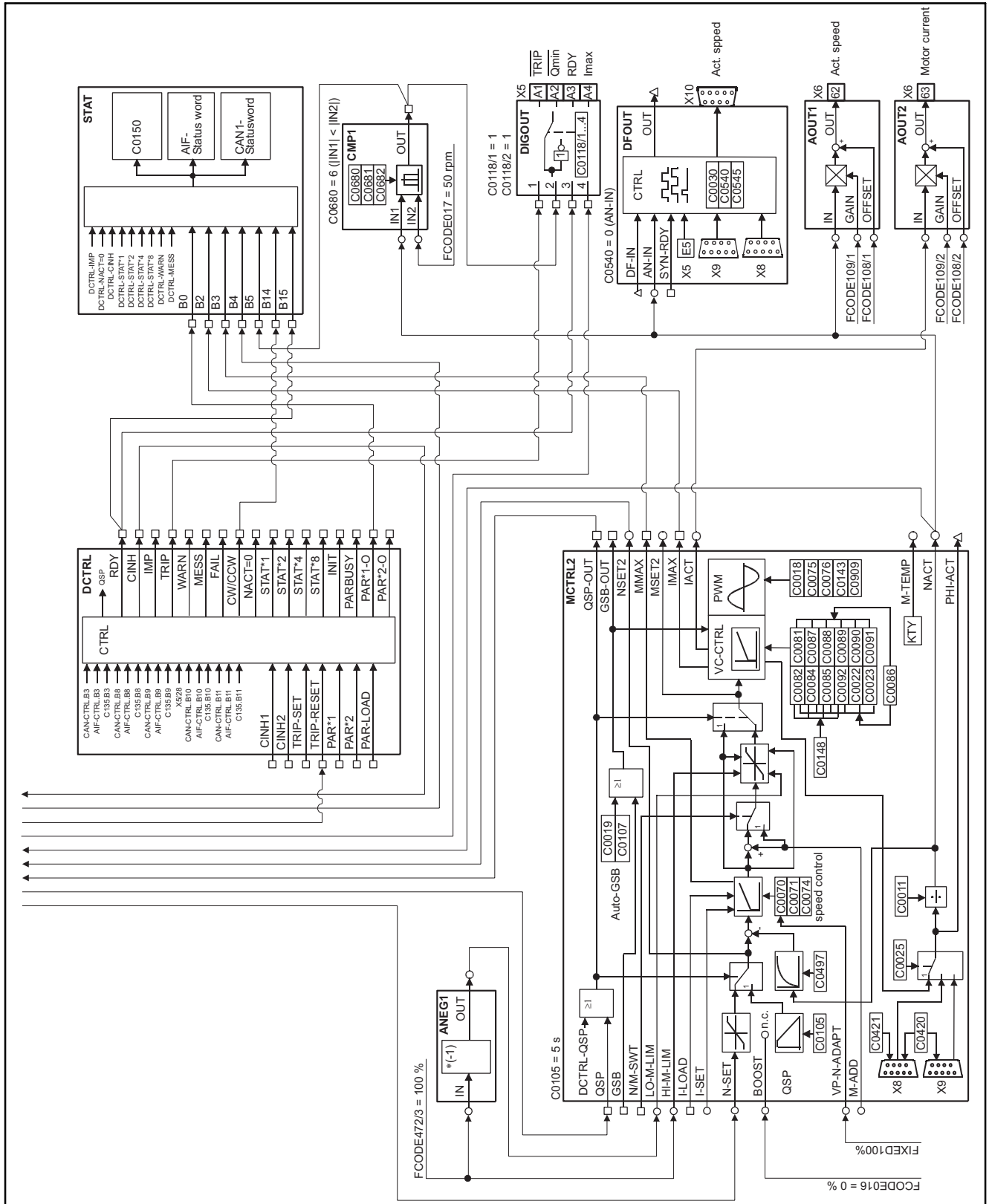
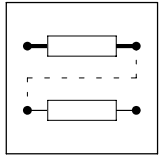
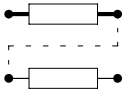

Fig. 4-8 Basic configuration 1300 - speed control with process controller (sheet 2)



Signal-flow charts

Speed control

4.2.4 Speed control with mains failure control (C0005 = 1400)

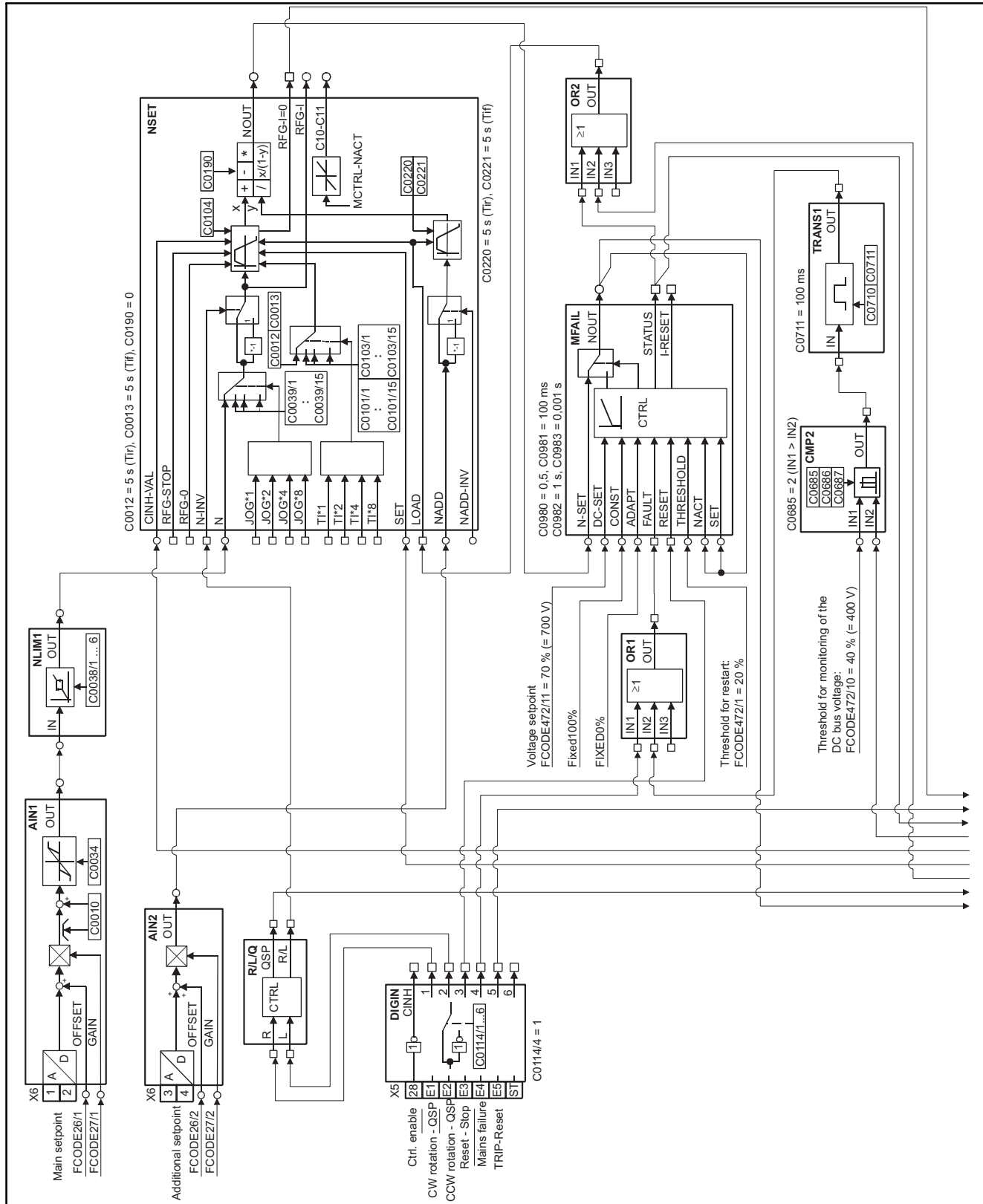
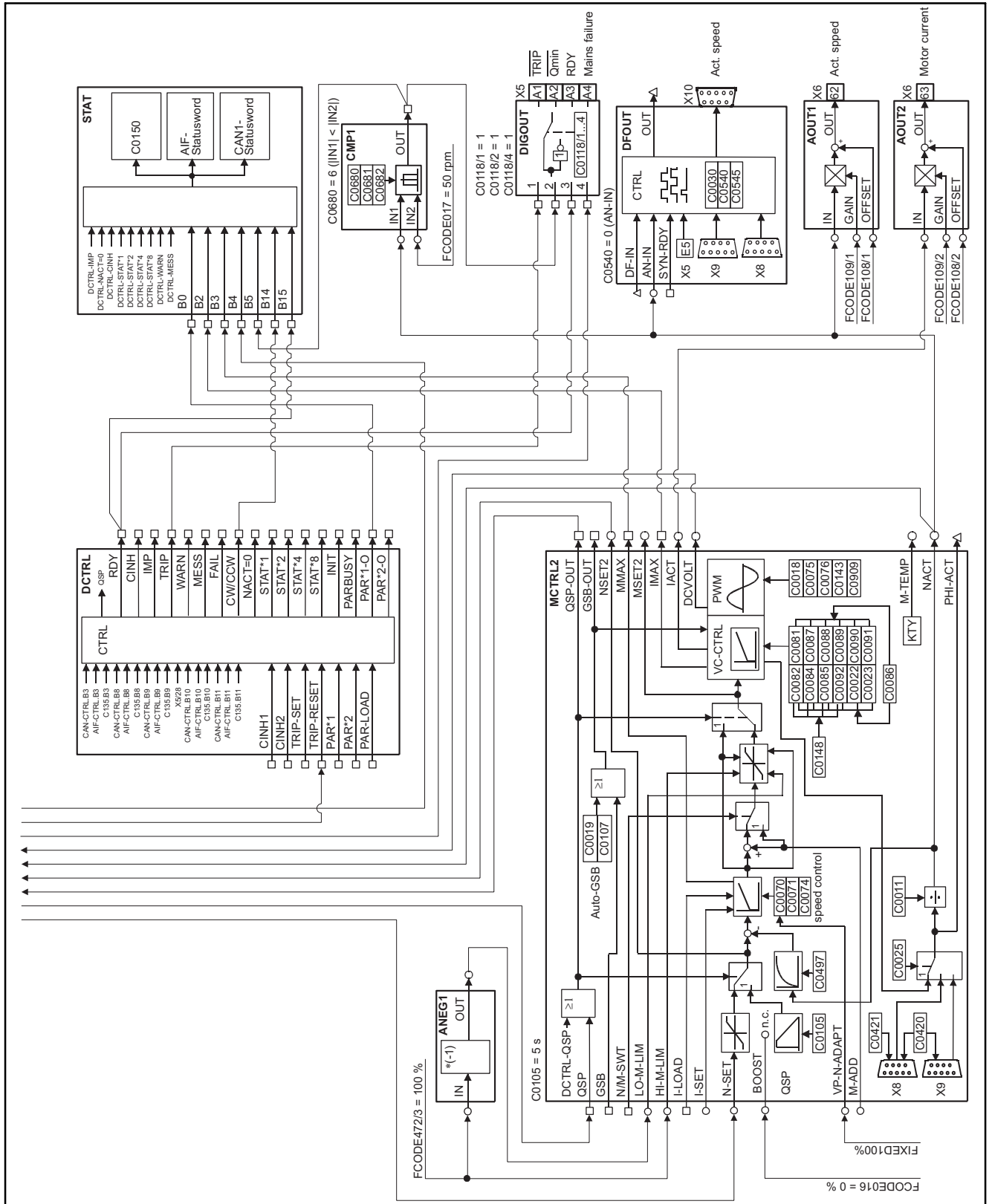
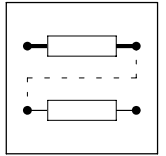
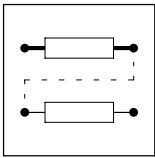

Fig. 4-9 Basic configuration 1400 - speed control with mains failure control (sheet 1)





Signal-flow charts

Speed control

4.2.5 Speed control with digital frequency input (C0005 = 1500)

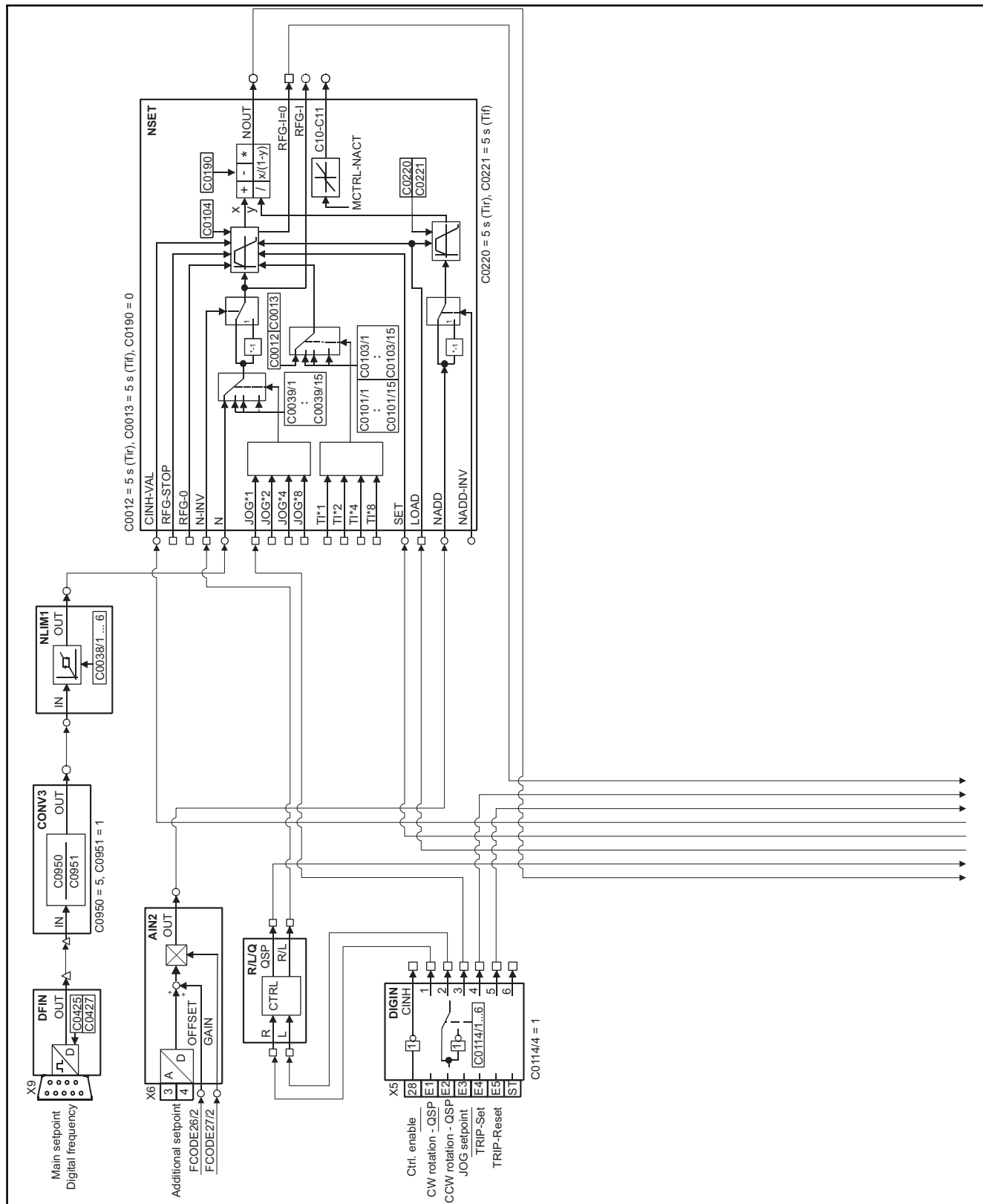

Fig. 4-11 Basic configuration 1000 - speed control with digital frequency input (sheet 1)

Signal-flow charts

Speed control

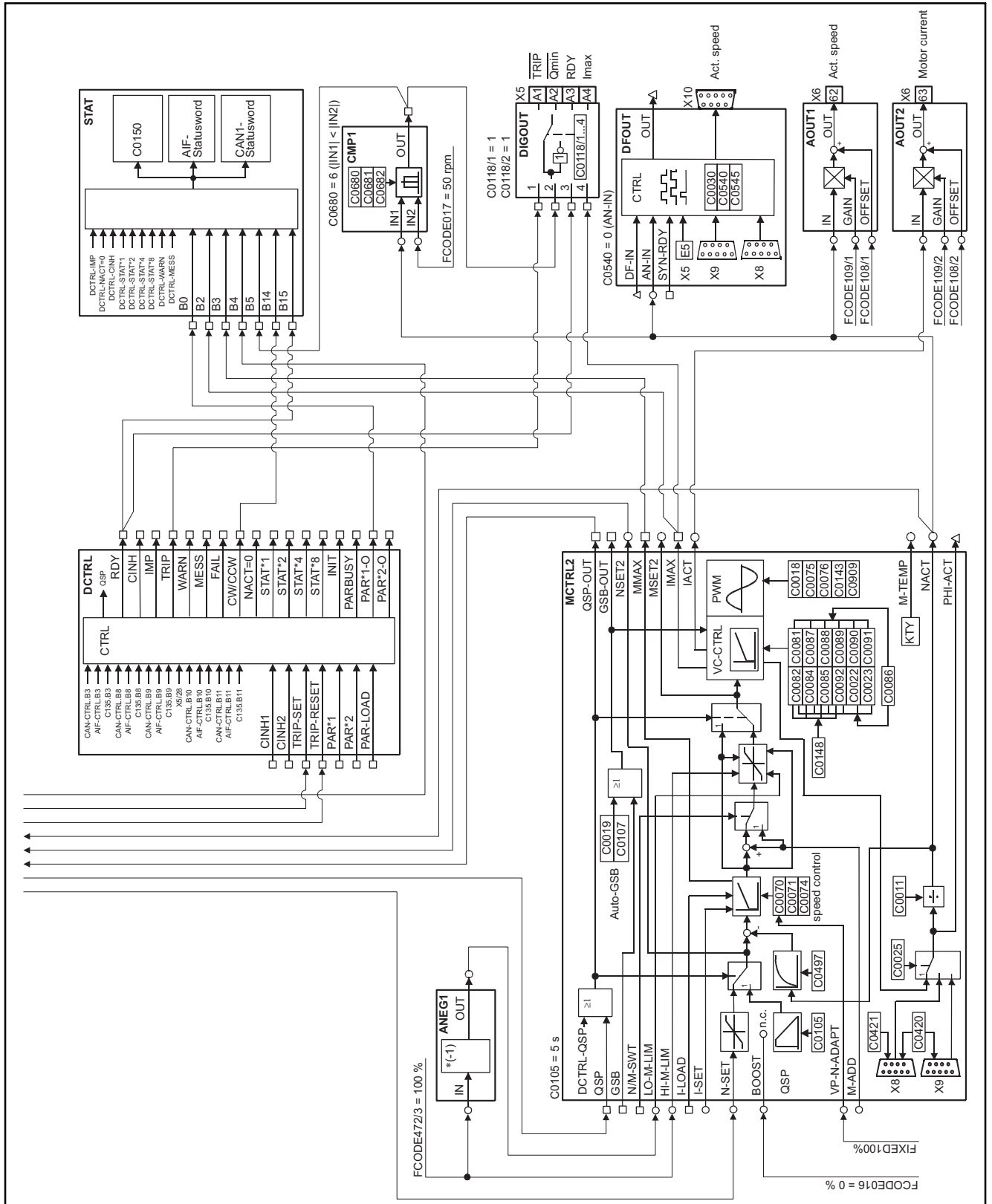
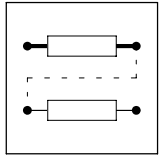

Fig. 4-12 Basic configuration 1000 - speed control with digital frequency input (sheet 2)

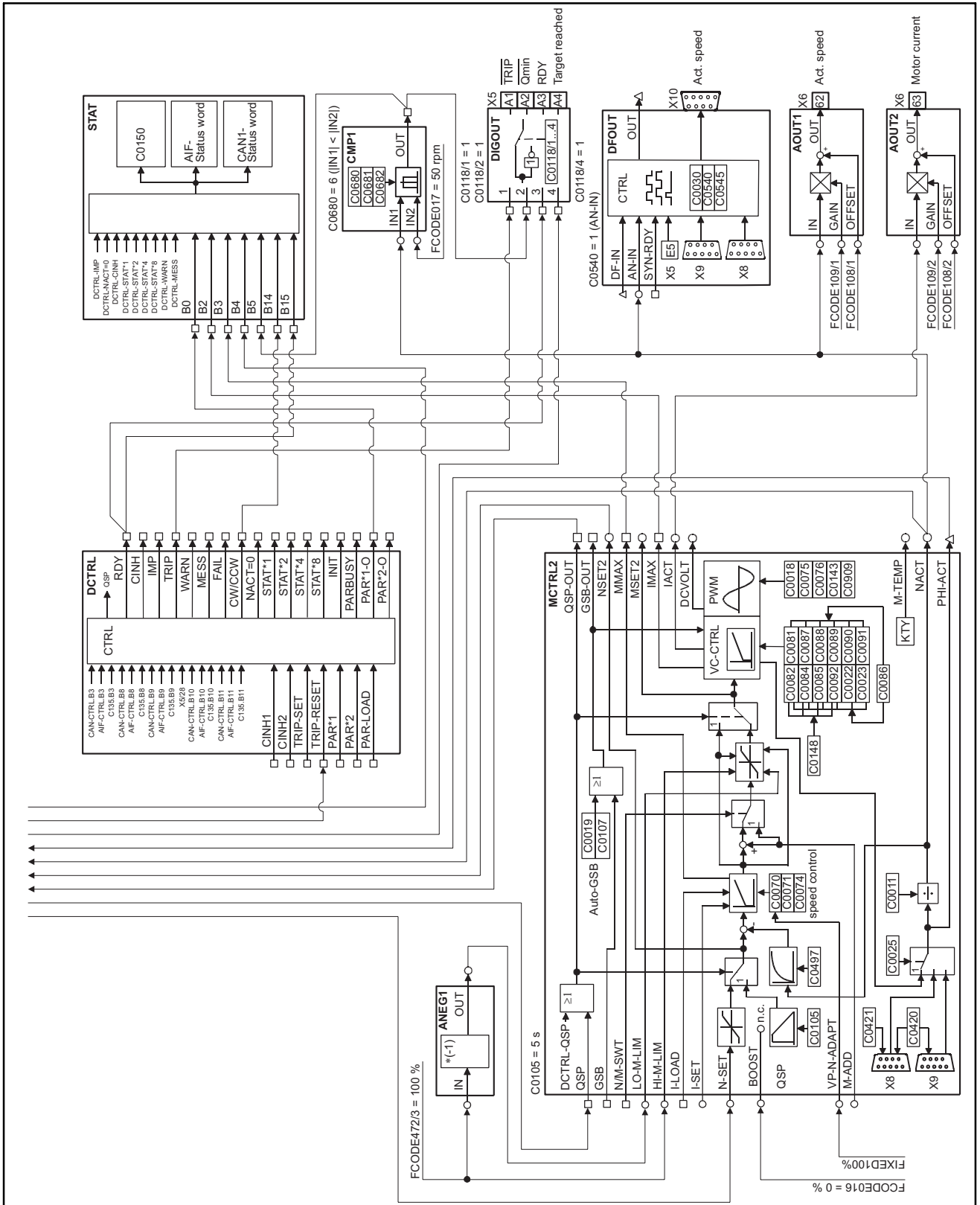
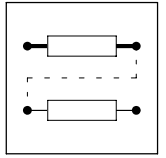
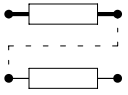

Fig. 4-14 Basic configuration 2000 - step control (sheet 2)



Signal-flow charts

Traversing control

4.4 Traversing control (C0005 = 3000)

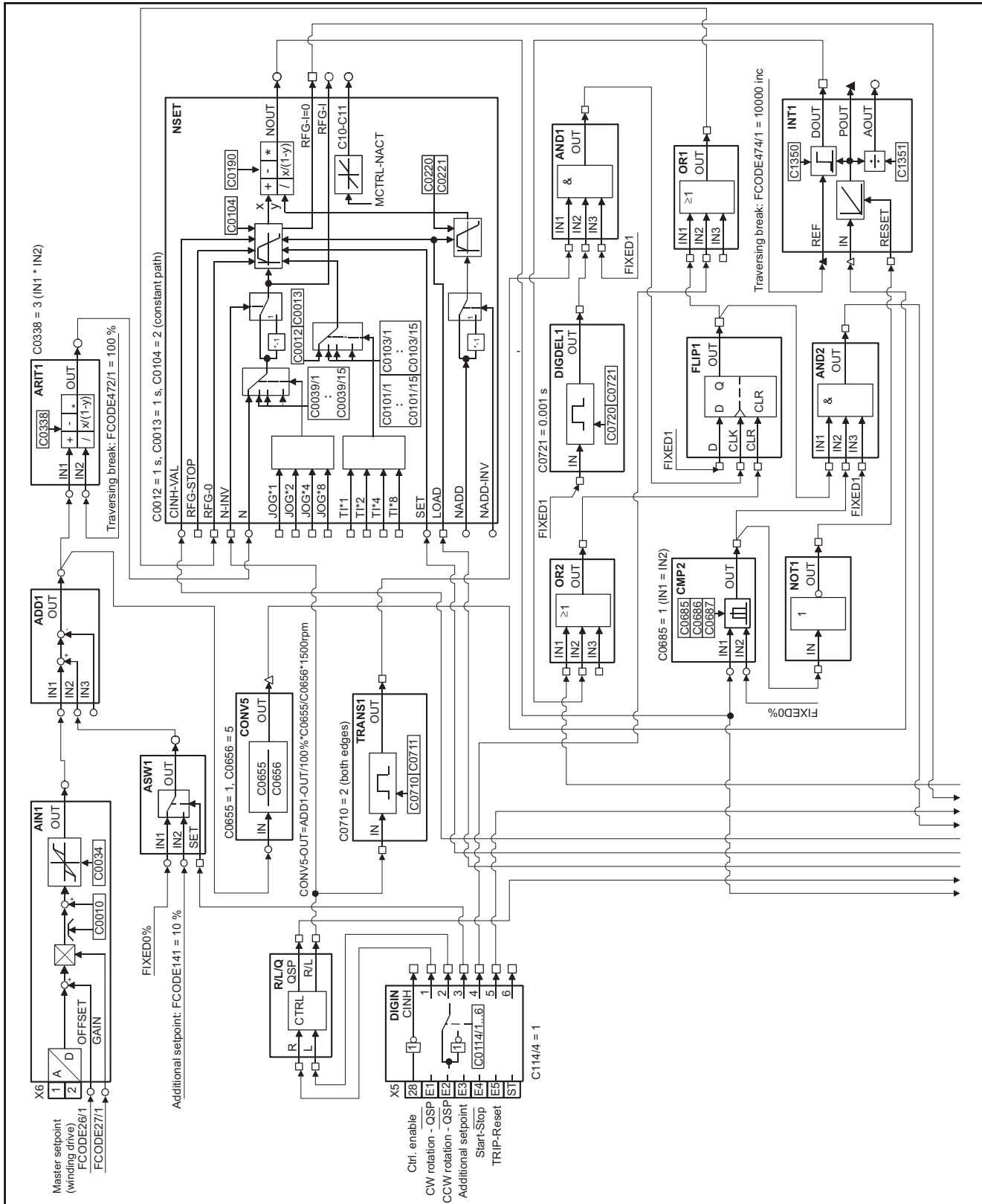

Fig. 4-15 Basic configuration 3000 - traversing control (sheet 1)

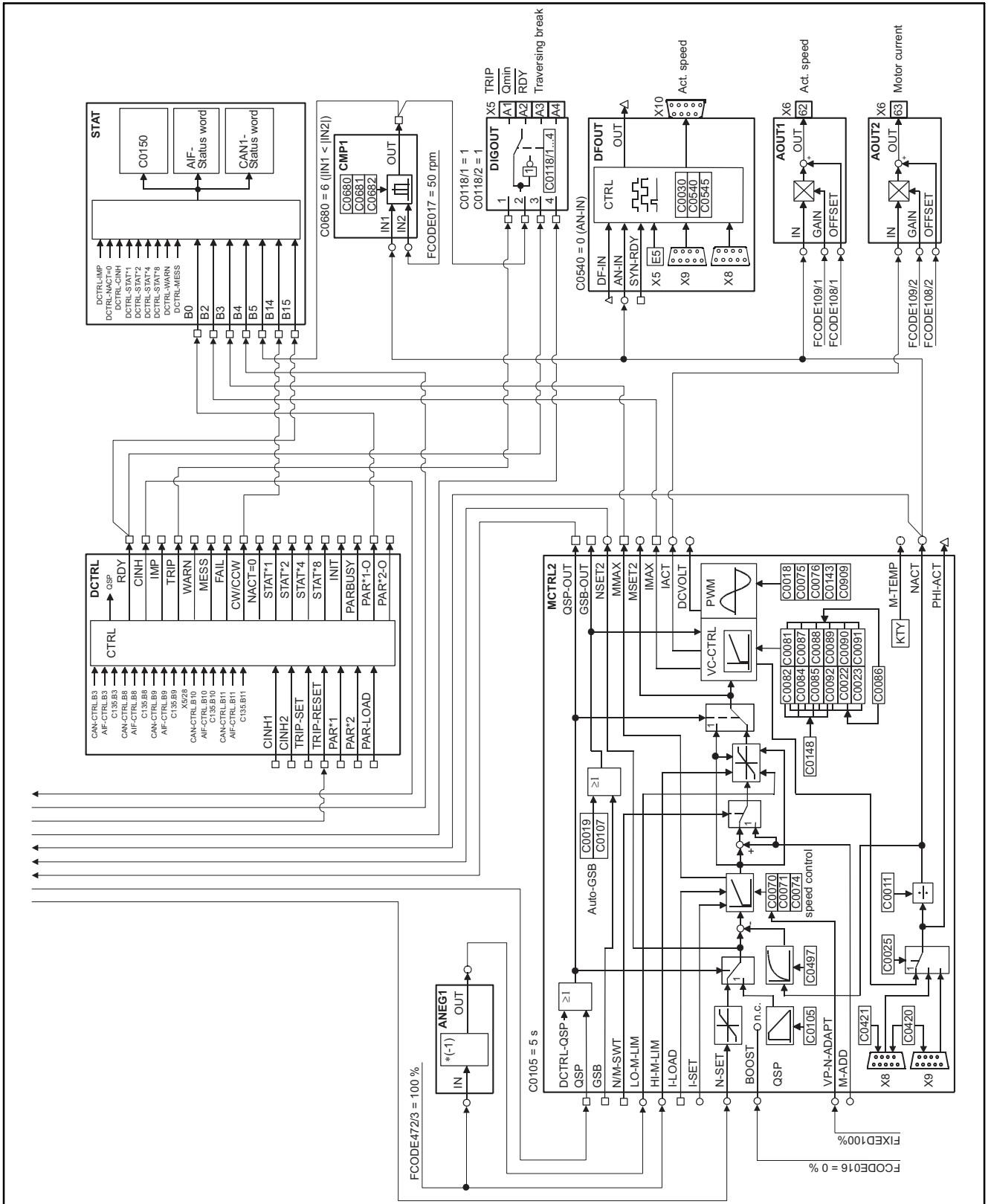
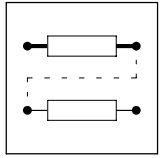
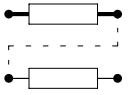

Fig. 4-16 Basic configuration 3000 - traversing control (sheet 2)



Signal-flow charts

Torque control

4.5 Torque control (C0005 = 4000)

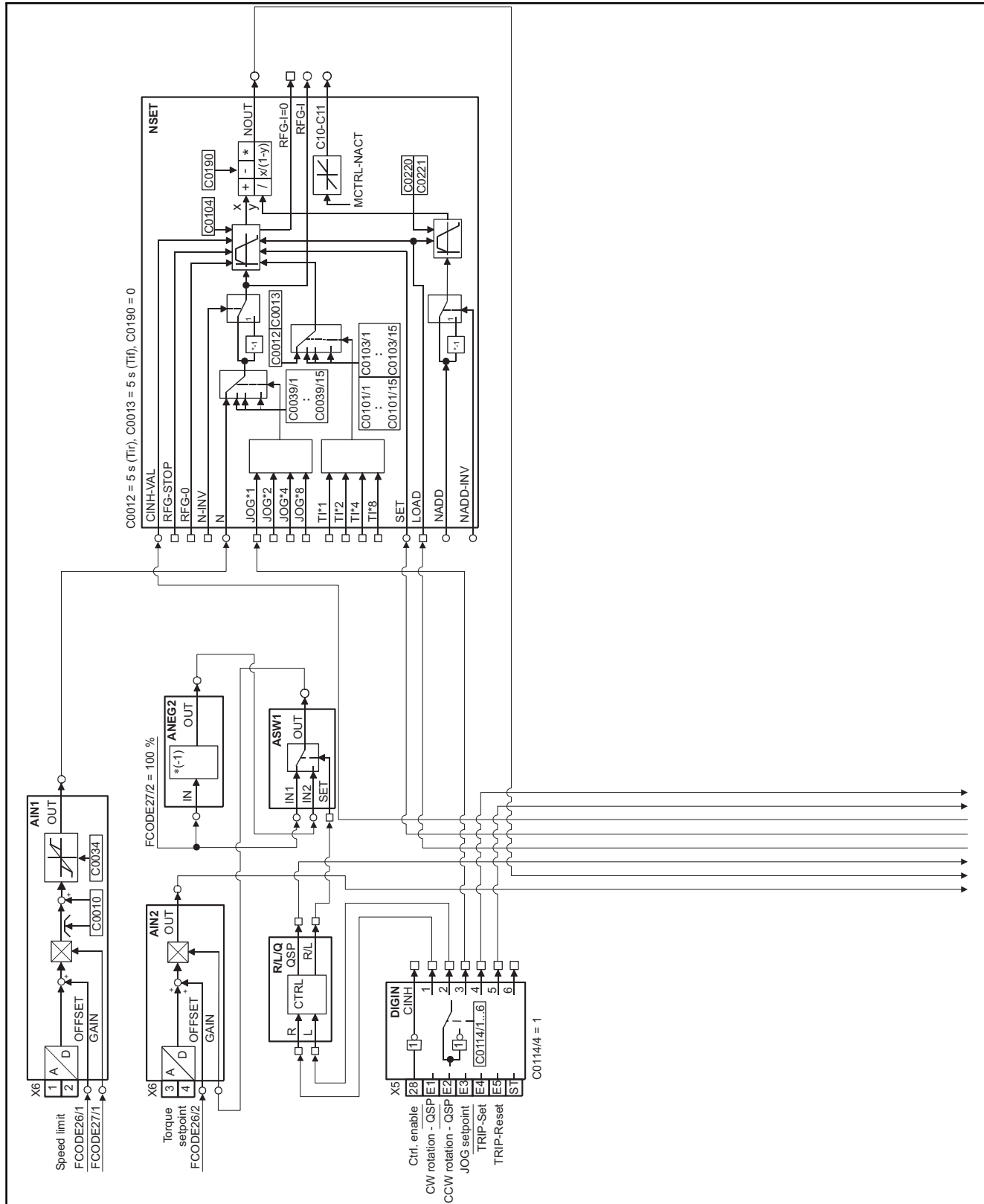
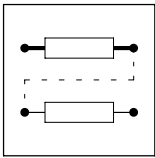

Fig. 4-17 Basic configuration 4000 - torque control (sheet 1)



Signal-flow charts

Digital frequency master

4.6 Digital frequency master (C0005 = 5000)

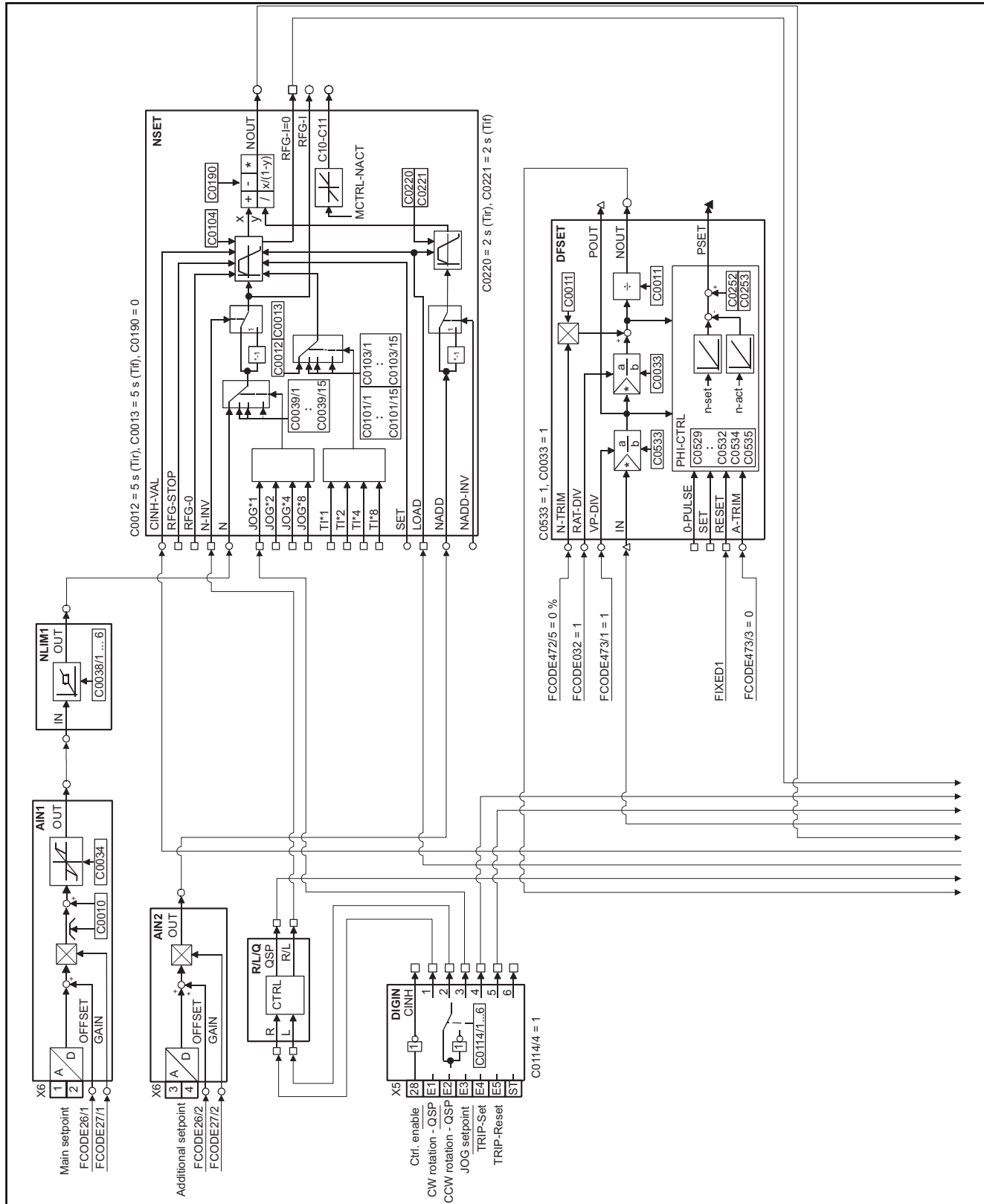

Fig. 4-19 Basic configuration 5000 - digital frequency master (sheet 1)

Signal-flow charts

Digital frequency master

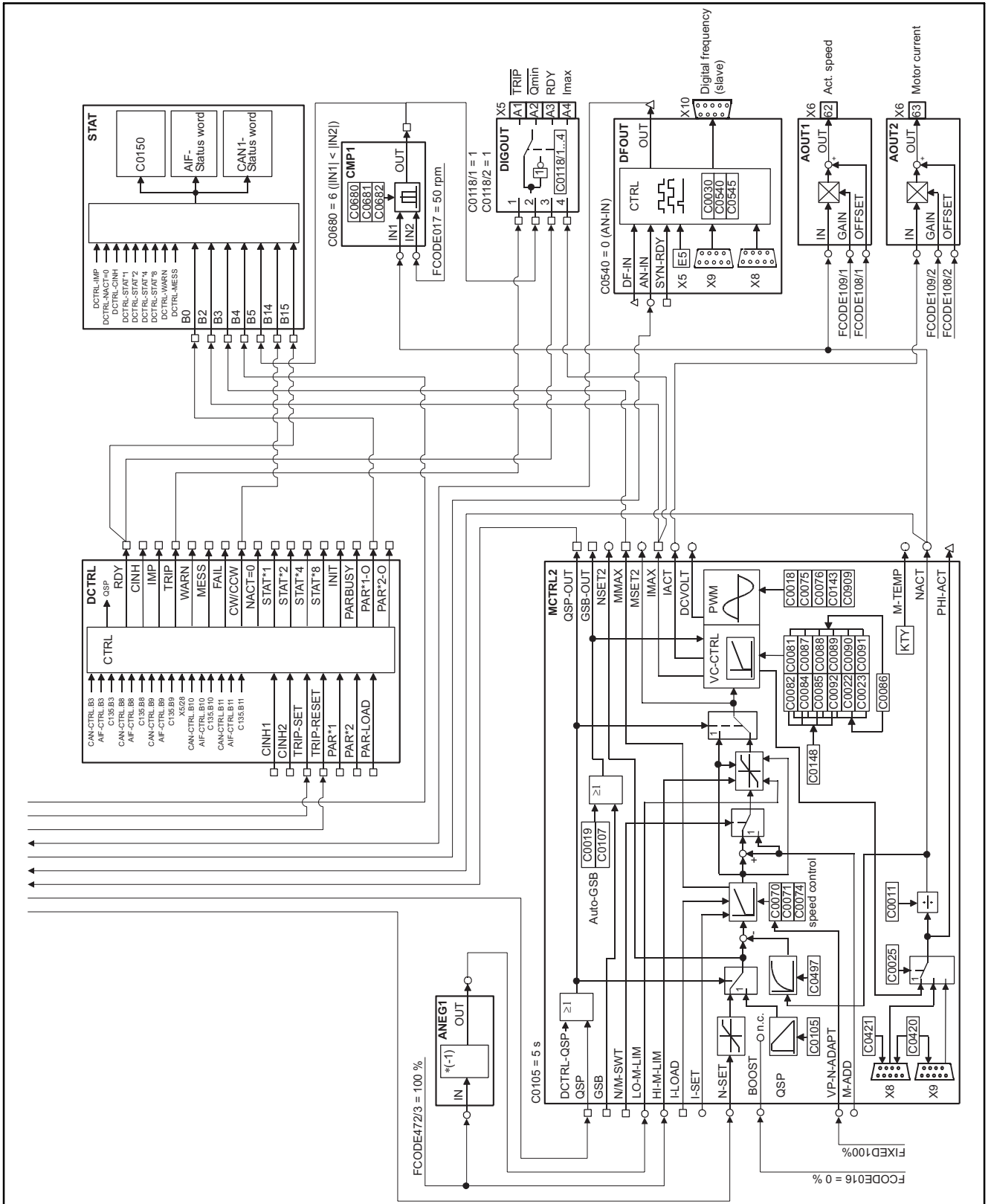
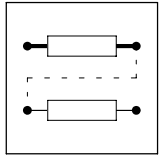
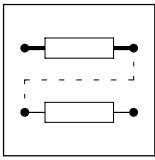

Fig. 4-20 Basic configuration 5000 - digital frequency master (sheet 2)



Signal-flow charts

Digital frequency bus

4.7 Digital frequency bus (C0005 = 6000)

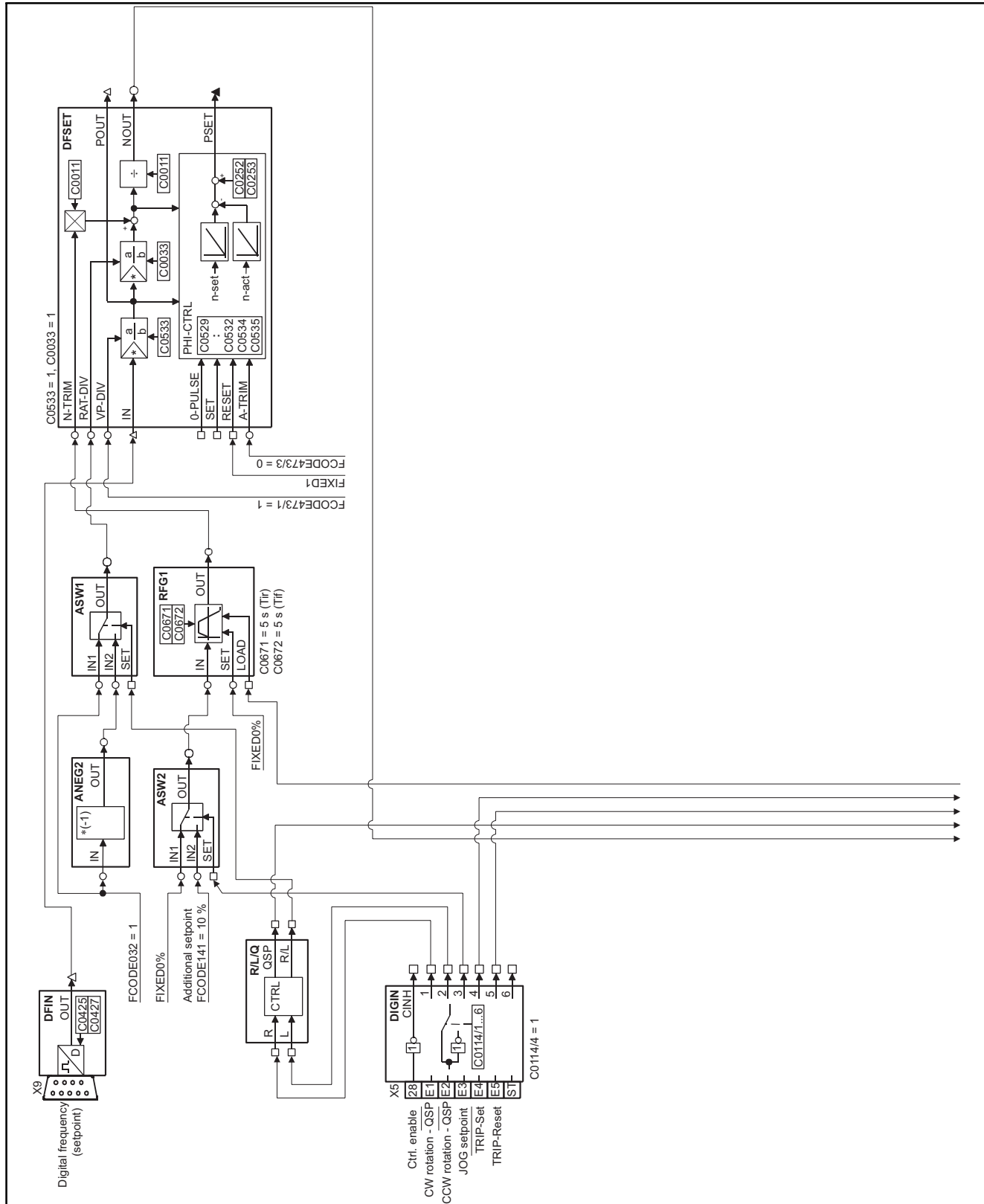

Fig. 4-21 Basic configuration 6000 - digital frequency bus (sheet 1)

Signal-flow charts

Digital frequency bus

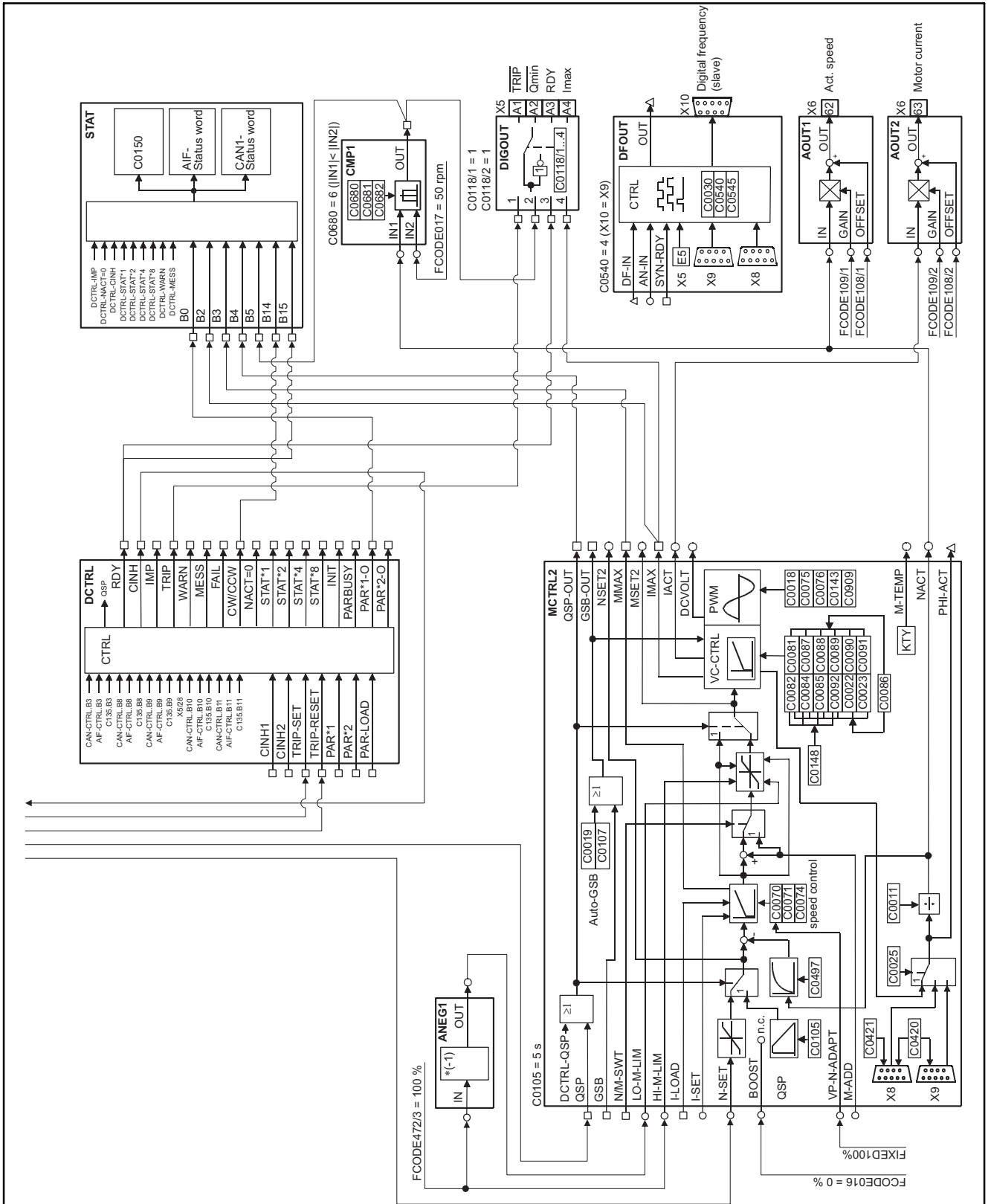
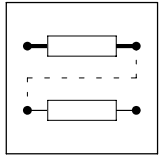
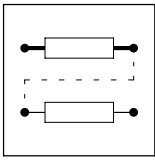

Fig. 4-22 Basic configuration 6000 - digital frequency bus (sheet 2)



Signal-flow charts

Digital frequency cascade

4.8 Digital frequency cascade (C0005 = 7000)

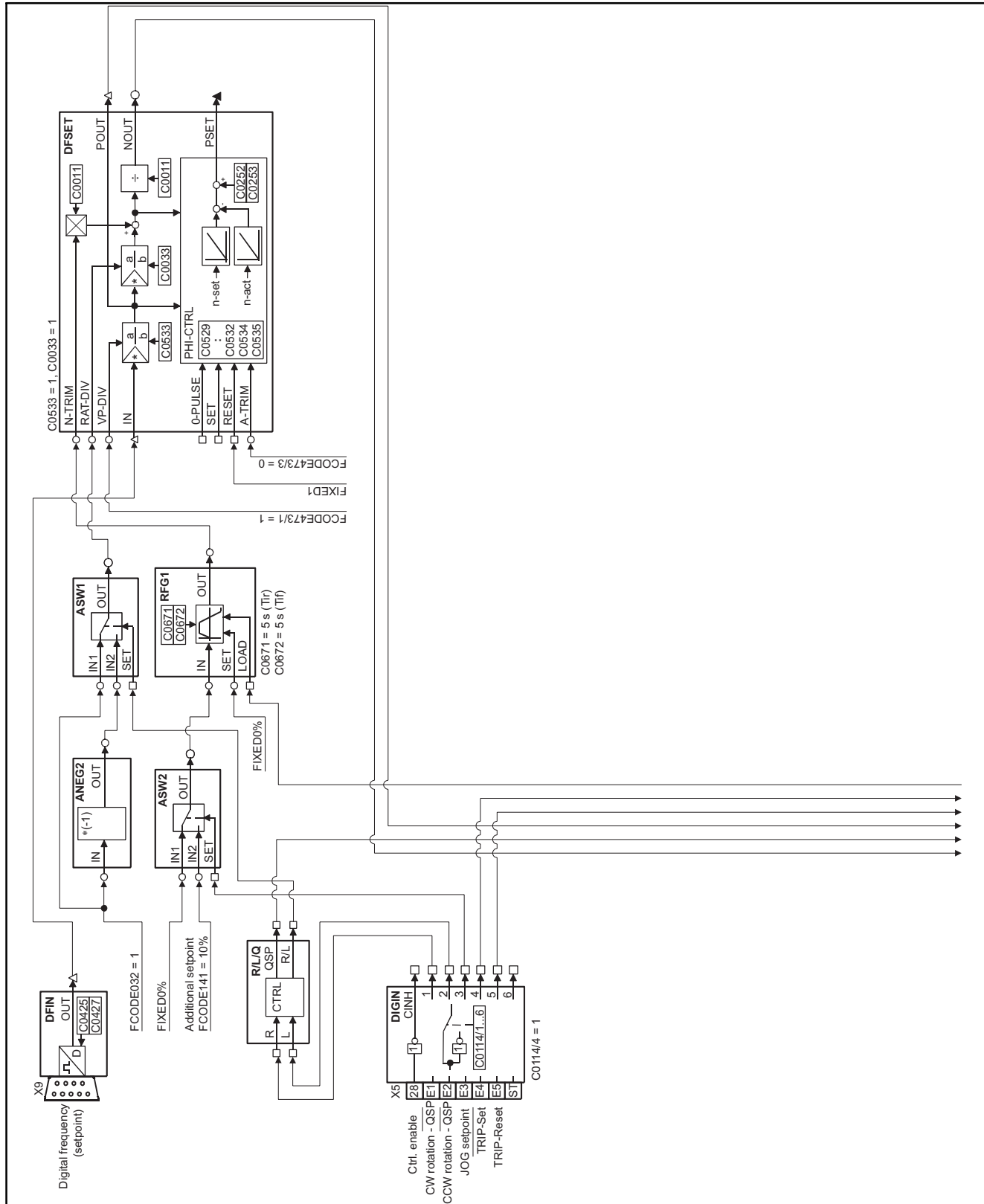
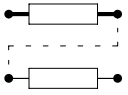

Fig. 4-23 Basic configuration 7000 - digital frequency cascade (sheet 1)



Signal-flow charts

Dancer position control (external diameter calculator)

4.9 Dancer position control (external diameter calculator) (C0005 = 8000)

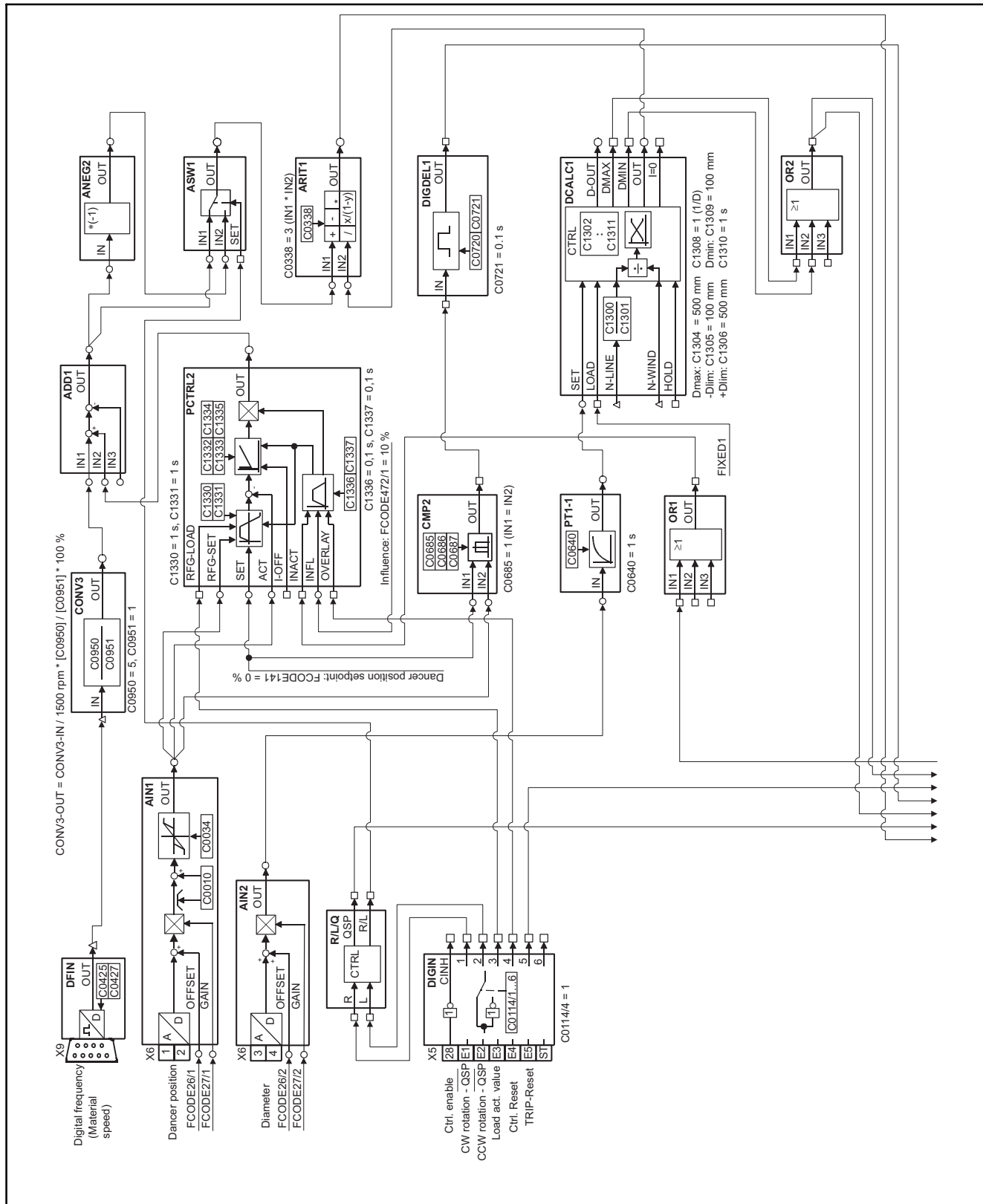

Fig. 4-25 Basic configuration 8000 - dancer position control with external diameter calculator (sheet 1)

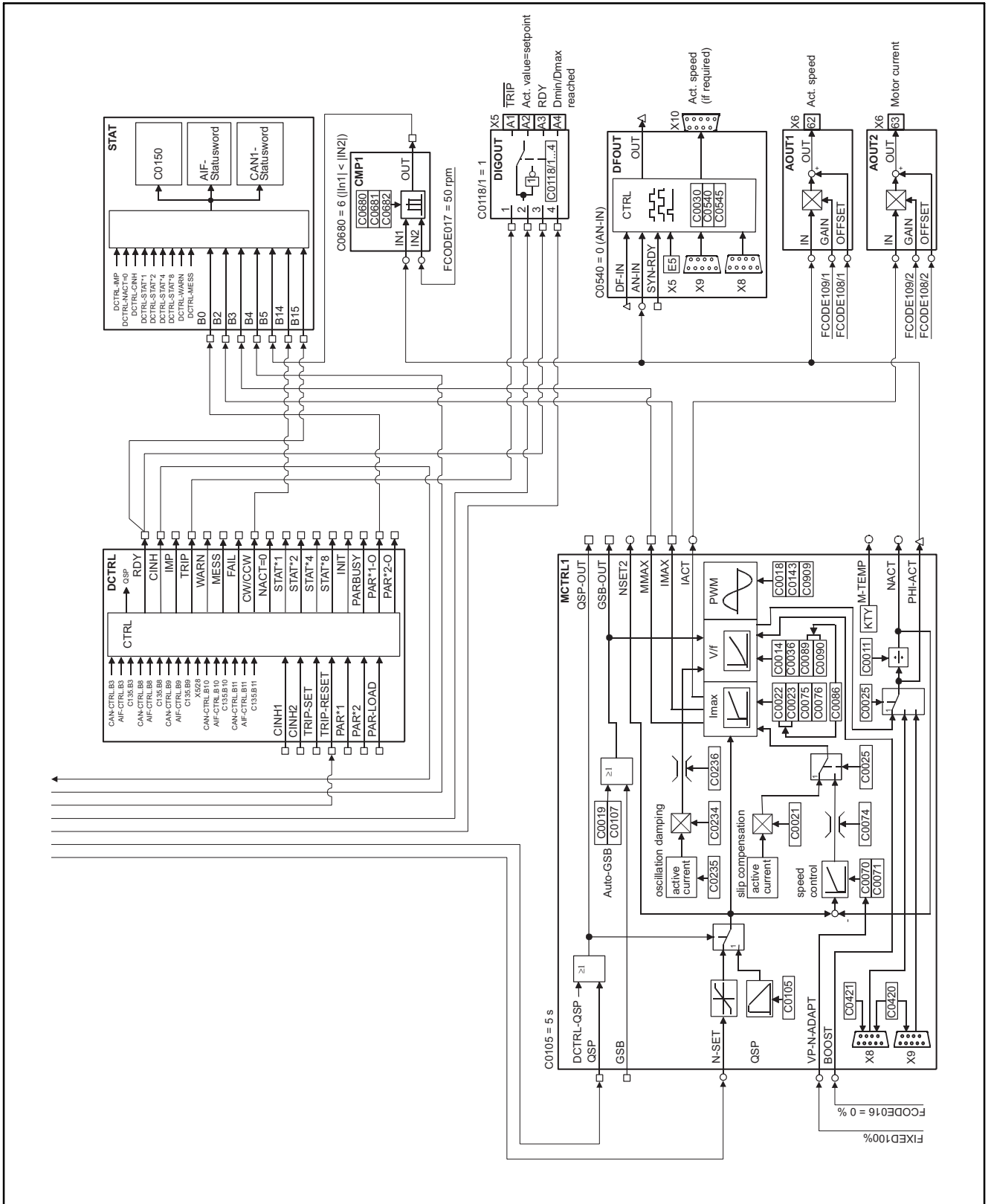
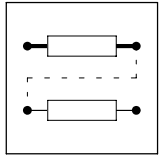
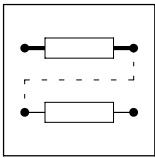

Fig. 4-26 Basic configuration 8000 - dancer position control with external diameter calculator (sheet 2)



Signalflußpläne

Dancer position control (internal diameter calculator)

4.10 Dancer position control (internal diameter calculator) (C0005 = 9000)

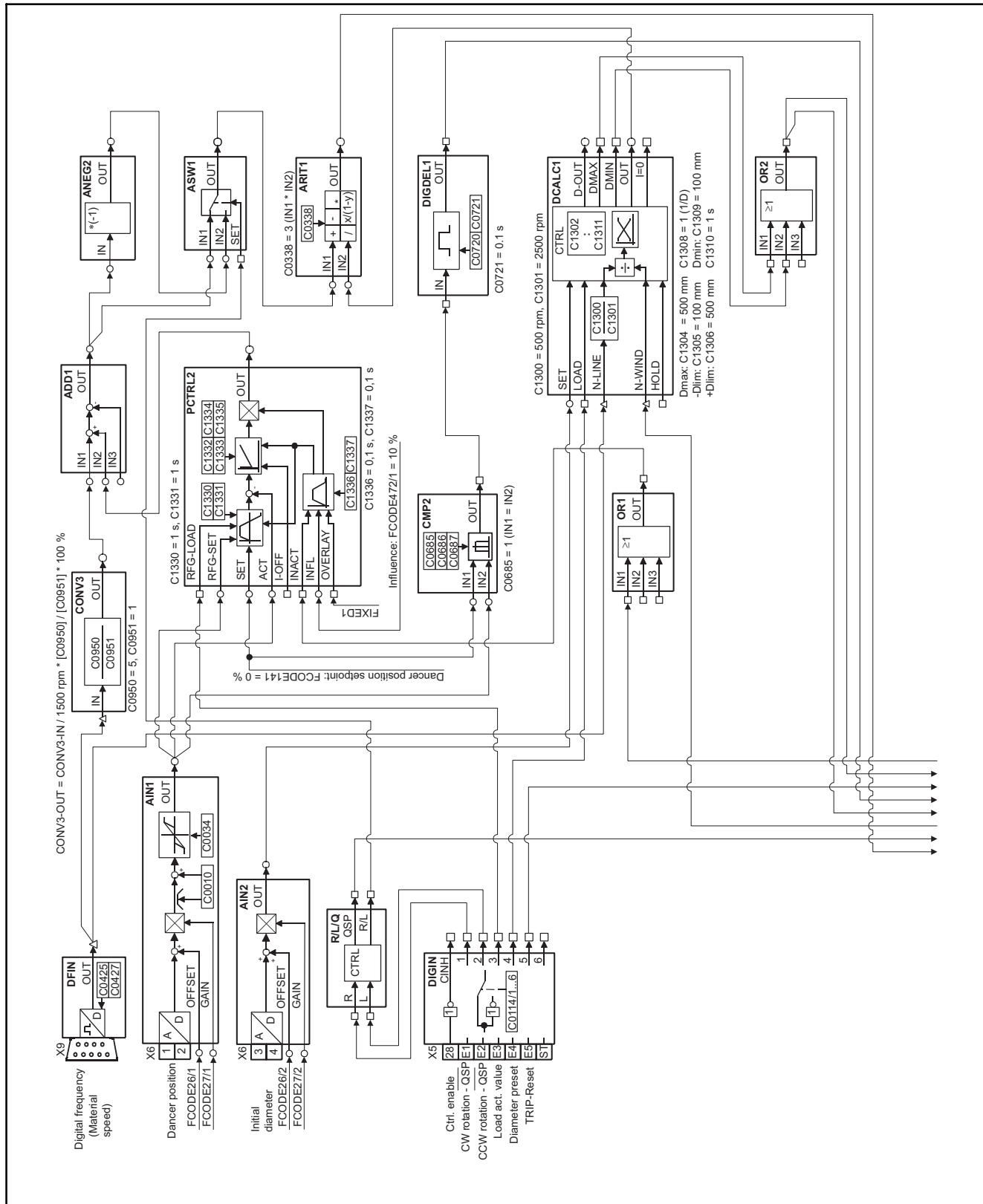

Fig. 4-27 Basic configuration 9000 - dancer position control with internal diameter calculator (sheet 1)

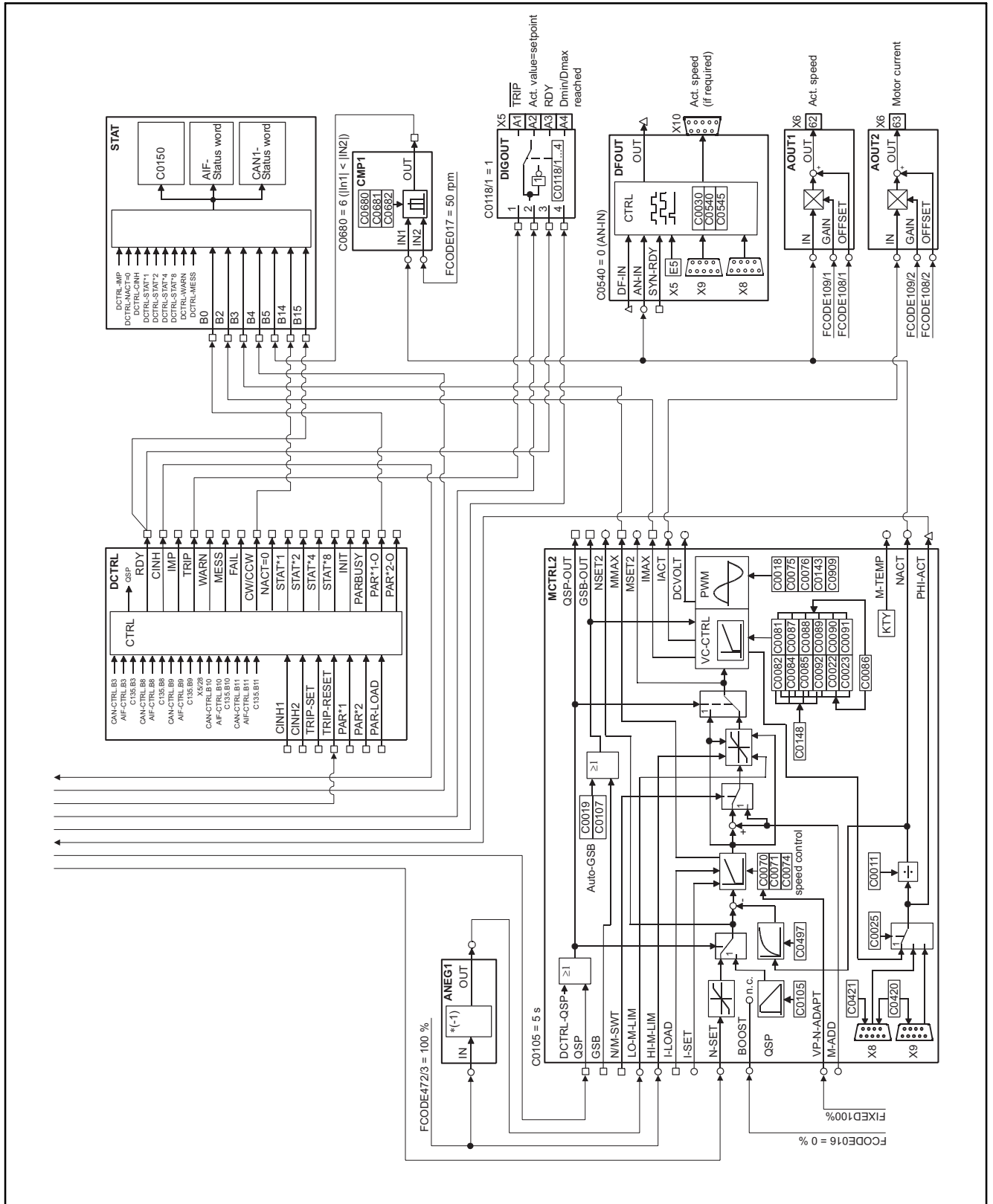
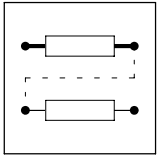
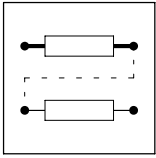
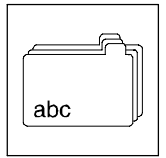

Fig. 4-28 Basic configuration 9000 - dancer position control with internal diameter calculator (sheet 2)



Signalflußpläne

Dancer position control (internal diameter calculator)



5 Appendix

Contents

5.1 Terminology and abbreviations used	5-3
5.2 Index	5-5

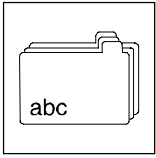

Appendix

Contents

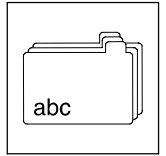

5.1 Terminology and abbreviations used

AIF	Automation interface AIF interface, interface for communication modules
Controller	Any frequency inverter, servo inverter or DC speed controller
Drive	Lenze controller in combination with a geared motor, a three-phase AC motor and other Lenze drive components
Cxxx/y	Subcode y of code Cxxx (e.g. C0404/2 = subcode 2 of code C0404)
Xk/y	Terminal y on terminal strip Xk (e.g. X5/28 = terminal 28 on terminal strip X5)
	Cross-reference to a chapter and the corresponding page number
V_{mains} [V]	Mains voltage
V_{DC} [V]	DC-supply voltage
V_M [V]	Output voltage
I_{mains} [A]	Mains current
I_r [A]	Rated output current
I_{max} [A]	Maximum output current
I_{PE} [mA]	Discharge current
P_r [kW]	Rated motor power
P_v [W]	Power loss of inverter
P_{DC} [kW]	For operation with power-adapted motor, additional power which can be drawn from the DC bus
S_N [kVA]	Output power of controller
M_r [Nm]	Rated torque
f_{max} [Hz]	Maximum frequency
L [mH]	Inductance
R [Ω]	Resistance
AC	AC current or AC voltage
DC	DC current or DC voltage
DIN	German standardisation institute
EMC	Electromagnetic compatibility
EN	European standard
IEC	International Electrotechnical Commission
IP	International Protection Code

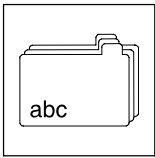

Appendix

Terminology and abbreviations used

NEMA	National Electrical Manufacturers Association
VDE	Association of German Electrotechnical Engineers
CE	Communauté Européene
UL	Underwriters Laboratories

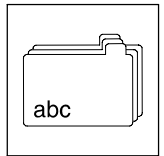

5.2 Index

A

Absolute value generation (ABS), 2-46
 Acceleration functions, 2-140
 Additional setpoint, 2-141
 Analog inputs (AIN), 2-53
 Analog outputs (AOUT), 2-59
 AND operation (AND), 2-55
 Arithmetic (ARIT), 2-61
 Automation interface (AIF-IN), 2-48
 Automation interface (AIF-OUT), 2-51

B

Blocking frequencies (NLIM), 2-133

C

Change-over (ASW), 2-63
 Changing the parameter set (PAR), 2-87
 Characteristic function (CURVE), 2-79
 Code assignment (FEVAN), 2-102
 Communication
 fault message CE0, 2-166
 fault message CE1, CE2, CE3, CE4, 2-166
 fault message CE4, 2-166
 Comparison (CMP), 2-71
 Configuration
 basic configuration, 2-6
 function blocks, 2-34
 Global Drive Control, 2-5
 monitoring, 2-164
 Control characteristic, Process controller (PCTRL), 2-148
 Gain PCTRL1, 2-148
 Gain PCTRL2, 2-149
 Controllerinhibit (CINH), 2-86
 Conversion (CONV), 2-76
 Conversion phase to analog (CONVPHA), 2-78
 Counter (FCNT), 2-98
 Curve follower (FOLL), 2-109
 CW/CCW/Quick stop (R/L/Q), 2-154

D

Dancer position control
 with external diameter calculator, Signal-flow charts, 4-28

 with internal diameter calculator, Signal-flow charts, 4-30
 Dead band (DB), 2-82
 Definition of notes used, 1-6
 Definitions, terminology, 5-2
 Delay (PT1), 2-151
 Delay elements (DIGDEL), 2-92
 Device control (DCTRL), 2-84
 Diameter calculator (DCALC), 2-83
 Differentiation (DT1-1), 2-97
 Digital frequency - master, Signal-flow charts, 4-22
 Digital frequency bus, Signal-flow charts, 4-24
 Digital frequency cascade, Signal-flow charts, 4-26
 Digital frequency input (DFIN), 2-88
 Digital frequency output (DFOUT), 2-89
 Digital frequency processing (DFSET), 2-91
 Digital frequency ramp function generator (DFRFG), 2-90
 Digital inputs (DIGIN), 2-95
 Digital outputs (DIGOUT), 2-96
 Digital status signals (STAT), 2-160

E

Earth fault, fault message OC3, 2-170
 Edge evaluation (TRANS), 2-161
 Encoder at pin X9/8, fault message Sd3, 2-180
 Encoder at X6/1,2, fault message Sd5, 2-180
 External encoder, fault message EER, 2-167

F

Fast mains recovery (KU), 2-127
 Field bus module, 2-48
 Flipflop (FLIP), 2-107
 Freedigital outputs (FDO), 2-100
 Function blocks, 2-34, 2-43, 2-47
 Absolute value generation (ABS), 2-46
 Addition (ADD), 2-47
 Analog inputs (AIN), 2-53
 Analog outputs (AOUT), 2-59
 arithmetic (ARIT), 2-61
 Automation interface (AIF-IN), 2-48
 Automation interface (AIF-OUT), 2-51
 Blocking frequencies (NLIM), 2-133
 building up a connection, 2-39
 Change-over (ASW), 2-63
 Characteristic function (CURVE), 2-79

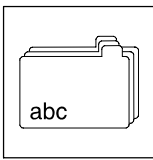

Appendix

Index

Code assignment (FEVAN), 2-102
Comparison (CMP), 2-71
configuration code, 2-36
connecting, 2-37
Conversion (CONV), 2-76
Conversion phase to analog (CONVPHA), 2-78
Counter (FCNT), 2-98
Curve follower (FOLL), 2-109
CW/CCW/Quick stop (R/L/Q), 2-154
dead band (DB), 2-82
Delay (DIGDEL), 2-92
Delay (PT1), 2-151
designation, 2-35
Device control (DCTRL), 2-84
 Change of parameter set (PAR), 2-87
 Controller inhibit (CINH), 2-86
 Operation inhibited (DISABLE), 2-86
 Quick stop (QSP), 2-85
 TRIP-RESET, 2-86
 TRIP-SET, 2-86
diameter calculator (DCALC), 2-83
differentiation (DT1-1), 2-97
Digital frequency input (DFIN), 2-88
Digital frequency output (DFOUT), 2-89
Digital frequency processing (DFSET), 2-91
Digital frequency ramp function generator (DFRFG), 2-90
Digital inputs (DIGIN), 2-95
Digital outputs (DIGOUT), 2-96
Digital status signals (STAT), 2-160
display code, 2-36
Edge evaluation (TRANS), 2-161
Flipflop (FLIP), 2-107
Freedigital outputs (FDO), 2-100
Holding brake (BRK), Set pulse inhibit, 2-68
Holdingbrake (BRK), 2-65
 Close brake, 2-66
 Disengaging the brake, 2-67
input name, 2-35
input symbol, 2-35
integrator (INT), 2-111
Internal motor control
 Vector control (MCTRL2), 2-115
 with V/f characteristic control (MCTRL1), 2-114
Inversion (ANEG), 2-58
Limitation (LIM), 2-113
Logic AND (AND), 2-55
Logic NOT (NOT), 2-134
Logic OR , 2-142
mains failure control (MFAIL), 2-116
Monitor outputs of monitoring system (MONIT), 2-129
motor phase failure detection (MLP), 2-128
Motor potentiometer (MPOT), 2-130
Oscilloscope function (OSZ), 2-145
output name, 2-36
output symbol, 2-36
parameterisation code, 2-36
Process controller (PCTRL), Controller for pressure, level, dancer position, 2-146
Programming of fixed setpoints (FIXSET), 2-105
Ramp function generator (RFG), 2-152

removing a connection, 2-40
S-ramp function generator (SRFG), 2-157
Sample & Hold (S&H), 2-155
signal types, 2-34
speed preconditioning (NSET), 2-136
Square-root calculator (SQRT), 2-156
system bus (CAN-IN), 2-70
system bus (CAN-OUT), 2-70

G

Global Drive Control, configuration by means of, 2-5

H

Heatsink temperature
 fault message OH, 2-171
 fault message OH4, 2-172
Holdingbrake (BRK), 2-65

I

I x t overload, fault message OC5, 2-171
Initialisation error, fault message PI, 2-179
Integrator (INT), 2-111
Internal motor control
 V/f characteristic control (MCTRL1), 2-114
 with vector control (MCTRL2), 2-115
Inversion (ANEG), 2-58

J

JOG setpoint, 2-9, 2-17
JOG setpoints, 2-138

L

Limitation (LIM), 2-113
Logic NOT (NOT), 2-134
Logic OR , 2-142

M

Main setpoint channel, 2-138
Mains failure control, 2-119
Mains failure control (MFAIL), 2-116
 fast mains recovery (KU), 2-127
 mains failure control, 2-119
 mains failure detection, 2-117
 restart protection, 2-126
Mains failure detection, 2-117
Maximum speed, fault message (NMAX), 2-169
Monitor outputs of monitoring system (MONIT), 2-129

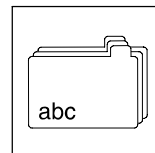

Monitoring

- communication fault - fieldbus module at X1 (CE0), 2-166
- communication fault - system bus (CE1, CE2, CE3), 2-166
- communication fault - system bus (CE4), 2-166
- earth fault (OC2), 2-170
- encoder at pin X9/8, 2-180
- encoder at X6/1, X6/2, 2-180
- error message via digital output, 2-182
- external encoder (EER), 2-167
- heatsink temperature (OH), 2-171
- heatsink temperature (OH4), 2-172
- l x t overload (OC5), 2-171
- initialisation error PI, 2-179
- maximum speed (NMAX), 2-169
- motor phases (LP1), 2-168
- motor temperature (OH3), 2-174
- motor temperature (OH7), 2-175
- motor temperature (OH8), 2-173
- overload at acceleration and deceleration (OC3), 2-170
- overvoltage in the DC bus (OU), 2-178
- parameter set errors PR1, PR2, PR3, PR4, 2-179
- parameter set errors PRO, 2-179
- sensor for motor temperature detection (Sd6), 2-181
- short circuit (OC1), 2-169
- system failure CCr, 2-166
- thermal sensor inside the device (H10, H11), 2-167
- undervoltage in the DC bus (LU), 2-176

Monitorings, 2-164

- monitoring functions, 2-165

Motor phase failure detection (MLP), 2-128

Motor phases, fault message LP1, 2-168

Motor potentiometer (MPOT), 2-130

Motor temperature

- fault message OH3, 2-174
- fault message OH7, 2-175
- fault message OH8, 2-173

N

Notes, definition, 1-6

O

Operation inhibited(DISABLE), 2-86

Oscilloscope function (OSZ), 2-145

Overload at acceleration or deceleration, fault message OC3, 2-170

Overvoltage in the DC bus, fault message OU, 2-178

P

Parameter set errors

- fault message PRO, 2-179
- fault messages PR1, PR2, PR3, PR4, 2-179

Process controller (PCTRL)

- Control characteristic, 2-148
- Gain PCTRL1, 2-148, 2-149
- Controller for dancer position, tension, pressure, 2-146
- Ramp generator, 2-149

Processing table, 2-41

- frequent errors, 2-42

Programming of fixed setpoints (FIXSET), 2-105

Q

Quick stop (QSP), 2-85

Quick stop deceleration time, 2-14, 2-17

R

Ramp function generator (RFG), 2-152

- Load, 2-153

Ramp function generator (SRFG), Load, 2-159

Ramp generator, Process controller (PCTRL), 2-149

- Deactivating, 2-150
- Evaluating the output signal, 2-150
- Load ramp generator PCTRL2, 2-150
- Value range of the output signal, 2-150

Restart protection, 2-126

S

S-ramp, PT1 element, 2-141

S-ramp function generator (SRFG), 2-157

Safety instructions

- definition, 1-6
- design, 1-6
- Layout
 - Other notes, 1-6
 - Warning of damage to material, 1-6
 - Warning of damage to persons, 1-6

Sample & Hold (S&H), 2-155

Sensor for motor temperature detection, fault message Sd6, 2-181

Setpoint inversion, ramp function generator, main setpoint, 2-139

Short circuit, fault message OC1, 2-169

Signal flow charts, Traversing control, 4-18

Signal-flow charts

- Dancer position control
 - with external diameter calculator, 4-28
 - with internal diameter calculator, 4-30
- Digital frequency - master, 4-22
- Digital frequency bus, 4-24
- Digital frequency cascade, 4-26
- Speed control, 4-4
 - with brake output, 4-6
 - with digital frequency input, 4-14
 - with mains failure control, 4-12
 - with motor potentiometer, 4-8
 - with process controller, 4-10

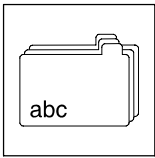

Appendix

Index

- Step control, 4-16
 - Torque control, 4-20
 - Speed control
 - Signal-flow charts, 4-4
 - with brake output, Signal-flow charts, 4-6
 - with digital frequency input, Signal-flow charts, 4-14
 - with mains failure control, Signal-flow charts, 4-12
 - with motor potentiometer, Signal-flow charts, 4-8
 - with process controller, Signal-flow charts, 4-10
 - Speed preconditioning (NSET), 2-136
 - acceleration functions, PT1 element, 2-140
 - additional setpoint, 2-141
 - JOG setpoints, 2-138
 - main setpoint, 2-138
 - S-ramp, PT1 element, 2-141
 - setpoint inversion, ramp function generator, main setpoint, 2-139
 - Square-root calculator (SQRT), 2-156
 - Step control, Signal-flow charts, 4-16
 - System, fault message CCr, 2-166
 - System bus (CAN-IN), 2-70
 - System bus (CAN-OUT), 2-70
- ### T
- Terminology
 - controller, 5-2
 - definitions, 5-2
 - drive, 5-2
 - Thermal sensors inside the device, fault message H10, H11, 2-167
 - Torque control, Signal-flow charts, 4-20
 - Traversing control, Signal-flow charts, 4-18
 - TRIP-RESET, 2-86
 - TRIP-SET, 2-86
- ### U
- Undervoltage in the DC bus, fault message LU, 2-176