



www.powergroup.com.ua

Operation manual

CHV110 Series Energy Saving Cabinet



CONTENTS

CONTENTS.....	1
Safety Precautions	3
1. INTRODUCTION	4
1.1 Technology Features	4
1.2 Description of Name Plate	5
1.3 Outside Dimensions of Energy Saver.....	6
2. UNPACKING INSPECTION.....	8
3. DISASSEMBLE AND INSTALLATION.....	9
3.1 Environmental Requirement	9
3.2 Dimensions of External Keypad.....	11
4. WIRING	12
4.1 Connections of Peripheral Devices	13
4.2 Terminal Configuration	14
4.3 Typical Wiring Diagram	16
4.4 Specifications of Breaker, Cable, Contactor and Reactor.....	17
4.5 Wiring the Main Circuits	19
4.6 Wiring Control Circuit Terminals	22
4.7 CHV110 installation	22
4.8 Installation Guidline to EMC Compliance	23
5. OPERATION.....	27
5.1 Operating Keypad Description	27
5.2 Operation Process.....	29
5.3 Running State	32
5.4 Quick Start	34
6. DETAILED FUNCTION DESCRIPTION.....	35
6.1 P0 Group--Basic Function.....	35
6.2 P1 Group--Start and Stop Control.....	44
6.3 P2 Group--Motor Parameters	50
6.4 P3 Group--Vector Control	51
6.5 P4 Group --V/F Control	55
6.6 P5 Group--Input Terminals	58
6.7 P6 Group -- Output Terminals	68
6.8 P7 Group --Display Interface	72

6.9 P8 Group --Enhanced Function	77
6.10 P9 Group --PID Control	86
6.11 PA Group --Simple PLC and Multi-step Speed Control	91
6.12 PB Group -- Protection Parameters	97
6.13 PC Group --Serial Communication	101
6.14 PD Group --Supplementary Function	101
6.15 PE Group --Factory Setting	102
7. TROUBLE SHOOTING	103
7.1 Fault and trouble shooting	103
7.2 Common Faults and Solutions	106
8. MAINTENANCE	108
8.1 Daily Maintenance	108
8.2 Periodic Maintenance	108
8.3 Warranty	109
9. INJECTION MOLDING MACHINE INTRODUCTION	110
9.1 Energy Saving Principle	110
9.2. Operation Guide	111
9.3. Installation and Debugging Procedures	112
10. LIST OF FUNCTION PARAMETERS	117

Safety Precautions

Please read this operation manual carefully before installation, operation, maintenance or inspection.

In this manual, the safety precautions were sorted to “WARNING” or “CAUTION”.



WARNING

Indicates a potentially hazardous situation which, if not, will result in death or serious injury.



CAUTION

Indicates a potentially hazardous situation which, if not avoided, will result in minor or moderate injury and physical damage. This sign is also used for alert of any un-safety operation.

In some cases, the contents of “CAUTION” could cause serious accident. Please follow these important precautions in any situation.

★ **NOTE** is the necessary step to ensure the proper operation.

Warning Marks were shown on the front keypad of inverters.

Please follow these indications when using the inverter.

WARNING

- **May cause injury or electric shock.**
- **Please follow the instructions in the manual before installation or operation.**
- **Disconnect all power line before opening front cover of unit. Wait at least 5 minutes until DC Bus capacitors discharge.**
- **Use proper grounding techniques.**
- **Never connect AC power to output UVW terminals**

1. INTRODUCTION

1.1 Technology Features

• Input & Output

- └ Power range : 7.5kW~110kW.
- └ Input Voltage Range: 1140/690/380/220V±15%
- └ Input Frequency Range: 47~63Hz
- └ Output Voltage Range: 0~rated input voltage
- └ Output Frequency Range: 0~400Hz

• I/O Features

- └ Programmable Digital Input: Provide 5 terminals which can accept ON-OFF inputs, and 1 terminal which can accept high speed pulse input (HD11).
- └ Programmable Analog Input: AI1 can accept input of 0~10V, AI2 can accept input of 0~10V or 0~20mA.
- └ Programmable Open Collector Output: Provide 2 output terminals. 1 output terminal is open collector output or high speed pulse output
- └ Relay Output: Provide 2 output terminals.
- └ Analog Output: Provide 1 output terminal.

└ • Main Control Function

- ◆ Control Mode: Sensorless vector control (SVC), V/F control.
- └ Overload Capacity: 60s with 150% of rated current, 10s with 180% of rated current.
- └ ◆ Starting Torque: 150% of rated torque at 0.5Hz (SVC);180% of rated torque at 0Hz(VC).
- └ Speed Adjusting Range: 1:100 (SVC); 1:1000 (VC)
- └ Speed Accuracy: ± 0.5% of maximum speed (SVC); ± 0.02% of maximum speed (VC)
- └ Carrier Frequency: 1.0kHz~16.0kHz.
- └ Frequency reference source: keypad, analog input, HDI, serial communication, multi-step speed, simple PLC and PID. The combination of multi-modes and the switch between different modes can be realized.
- └ Torque Control Function: Provide multiple torque setting source.
- └ PID control function
- └ Simple PLC or Multi-steps Speed Control: 16 steps speed can be set.

- ◆ Traverse control function
 - ◆ Length and time control
 - ◆ Non-Stop Function while instantaneous power failure
 - ◆ Speed Trace Function: Smoothly start the running motor.
 - ◆ QUICK/JOG Function: User defined shortcut key can be realized.
 - ◆ Automatic Voltage Regulation (AVR): Automatically keep the output voltage stable when input voltage is fluctuating
 - ◆ Up to 29 fault protections: over current, over voltage, under voltage, over heating, phase failure, over load etc.
- **Special Function For injection Molding Machine**
- ◆ Frequency source: Compare pressure and flow signals output, current (0~1A) and voltage (0~10V) signal are valid
 - ◆ Larger torque at low frequency, quick starting.
 - ◆ Enclosure IP21.
 - ◆ Main circuit bypass function
 - ◆ Built-in DC reactor (15kW~55kW), it can improve the power factor effectively.
 - ◆ Automatical reset and power failure reset function, it ensures the continuous production and the productivity.
 - ◆ Fault protection and self-locking.
 - ◆ Strong anti-jamming capability.
 - ◆ Energy-saving efficiency as high as 5%~10% than V/F control mode.

1.2 Description of Name Plate

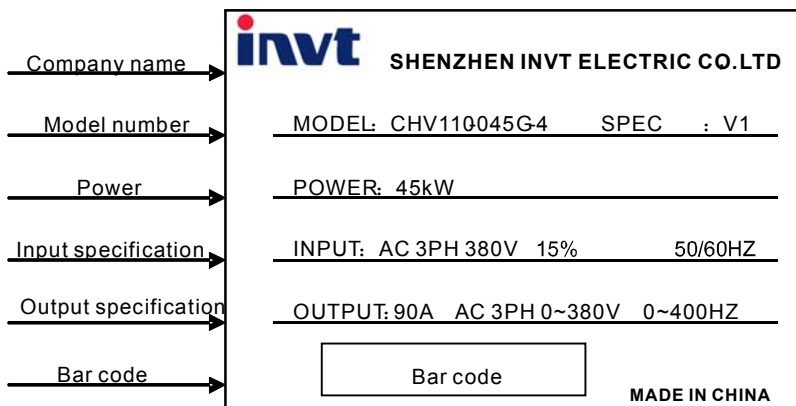

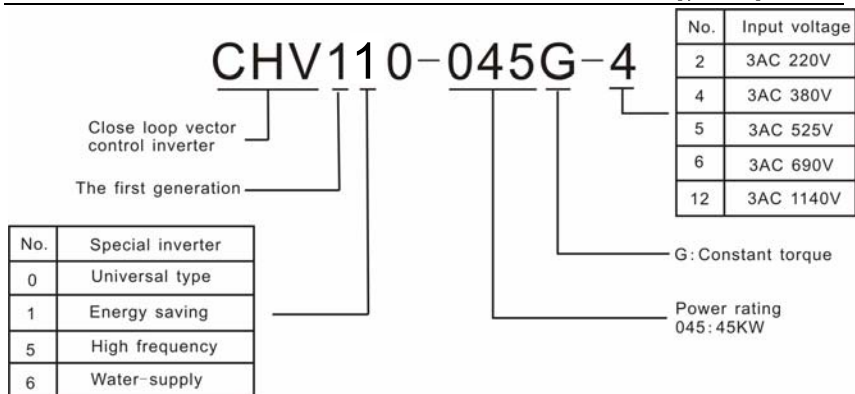

Figure 1.1 Nameplate of inverter.

1.3 Outside Dimensions of Energy Saver

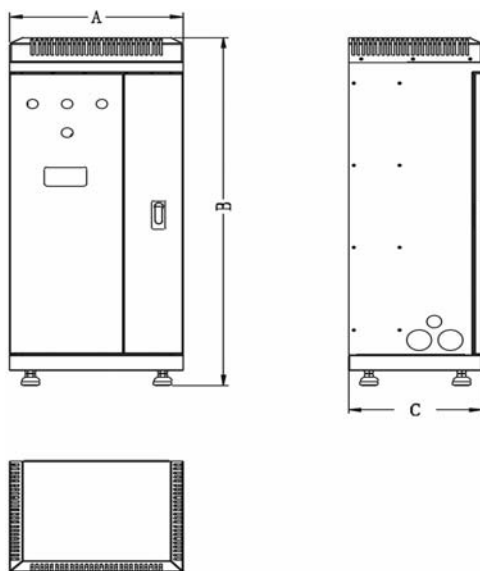

Figure1-2 Outside dimensions diagram of energy saver.

Model and Power Range	A (mm)	B(mm)	C(mm)	Rated output current(A)	Adaptation motor(kw)
CHV110-07RG-4	300	685	250	17	7.5
CHV110-011G-4				25	11
CHV110-015G-4				32	15

Model and Power Range	A (mm)	B(mm)	C(mm)	Rated output current(A)	Adaptation motor(kw)
CHV110-018G-4	350	846	270	37	18.5
CHV110-022G-4				45	22
CHV110-030G-4				60	30
CHV110-037G-4	390	935	285	75	37
CHV110-045G-4				90	45
CHV110-055G-4				110	55
CHV110-075G-4	540	1030	380	150	75
CHV110-090G-4	600	1170	380	176	90
CHV110-0110G-4	600	1170	380	210	110

2. UNPACKING INSPECTION



CAUTION

- **Never install or operate any inverter that is damaged or missing components. Doing so can result in injury.**

Check the following items when unpacking the inverter.

1. Inspect the entire exterior of the Inverter to see if there are any scratches or other damage resulting from shipping.
2. Ensure there is operation manual and warranty card in the packing box.
3. Ensure the nameplate that it is you ordered.
4. Ensure the optional parts are what you need if you ordered any optional parts.

Please contact the local agent if there is any damage of inverter or optional parts.

3. DISASSEMBLE AND INSTALLATION



WARNING

- Any untrained person working on any parts/systems of inverter or any rule in the "Warning" being violated, that will cause severe injury or property damage. Only licensed person, who has been trained on design, installation, commissioning and operation of inverter, is permitted to operate this equipment.
- Input power cable must be connected tightly, and the equipment must be grounded securely.
- Even if the inverter is not in operating situation, the following terminals still have dangerous voltage:
 - Power Terminals: R, S, T
 - Motor Connection Terminals: U, V, W.
- Can not install the inverter until discharged completely after the power supply is switched off for 5 minutes.
- The section area of grounding conductor must be no less than that of power supply cable.



CAUTION

- Lift the cabinet by its base; do not lift it by holding its panel. Otherwise the main unit will fall off to result in personal injury.
- Install the inverter on top of the fireproofing material (such as, metal) to prevent fire.
- When need install two or more inverters in one cabinet, cooling fan should be applied to make sure that the air temperature is lower than 45°C. Otherwise it could cause fire or damage the device.

3.1 Environmental Requirement

3.1.1 Temperature

Environment temperature range: -10°C~+40°C. Inverter will be derated if ambient temperature exceeds 40°C.

3.1.2 Humidity

Less than 95% RH, without dewfall.

3.1.3 Altitude

Inverter can output the rated power when installed with altitude of lower than 1000m. It will be derated when the altitude is higher than 1000m. For details, please refer to the following figure:

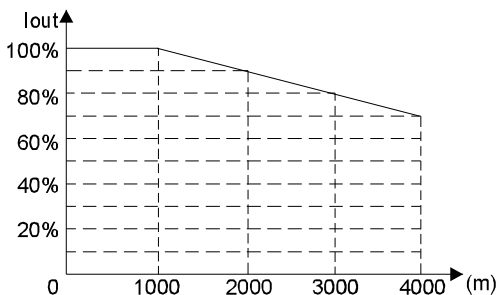

Figure 3.1 Relationship between output current and altitude.

3.1.4 Impact and Oscillation

It is not allowed that the inverter falls down or suffers from fierce impact or the inverter installed at the place that oscillation frequently. The maximum swing should less than 5.8m/s^2 (0.6g).

3.1.5 Electromagnetic Radiation

Keep away from the electromagnetic radiation source.

3.1.6 Water

Do not install the inverter at the wringing or dewfall place.

3.1.7 Air Pollution

Keep away from air pollution such as dusty, corrosive gas.

3.1.8 Storage

Do not store the inverter in the environment with direct sunlight, vapor, oil fog and vibration.

Keep a certain distance from inverter to the other items.

Keep the inflammable items, diluent, solvent away from the inverter.

If the inverter is installed on the wall, it should be fastened tightly.

3.2 Dimensions of External Keypad

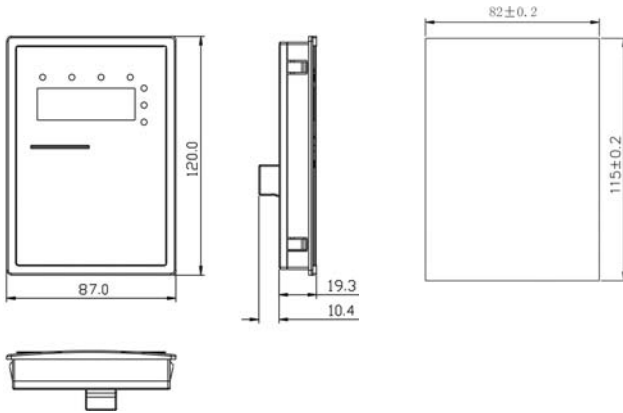

Figure 3.2 Dimension of keypad.

4. WIRING



WARNING

- Wiring must be performed by an authorized person qualified in electrical work.
- Do not test the insulation of cable that connects the inverter with high-voltage insulation testing devices.
- Can not install the inverter until discharged completely after the power supply is switched off for 10 minutes.
- Be sure to ground the ground terminal.
(200V class: Ground to 100Ω or less, 400V class: Ground to 10Ω or less, 660V class: Ground to 5Ω or less)

Otherwise, an electric shock or fire can occur.

- Connect input terminals (R, S, T) and output terminals (U, V, W) correctly.

Otherwise it will cause damage the inside part of inverter.

- Do not wire and operate the inverter with wet hands.

Otherwise there is a risk of electric shock.



CAUTION

- Check to be sure that the voltage of the main AC power supply satisfies the rated voltage of the Inverter.
- Injury or fire can occur if the voltage is not correct.
- Connect power supply cables and motor cables tightly.

4.1 Connections of Peripheral Devices

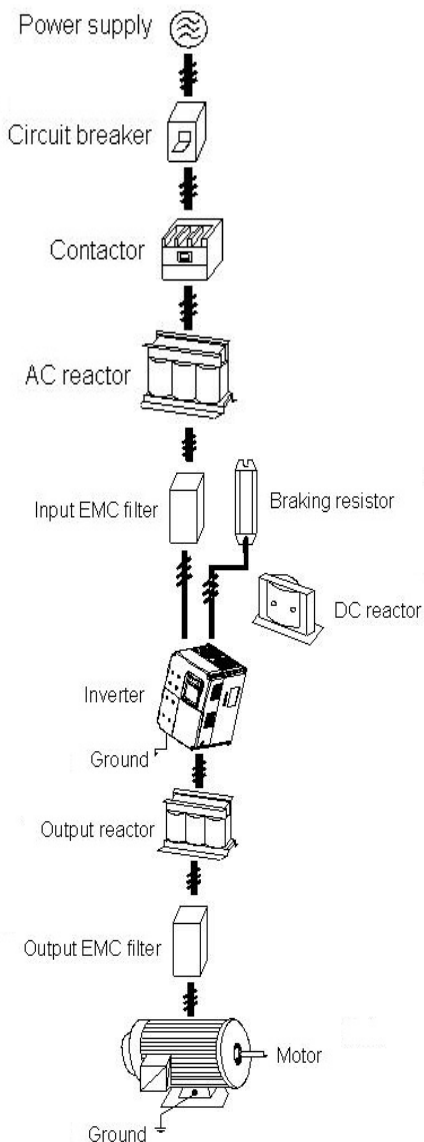

Figure 4.1 Connections of peripheral devices.

4.2 Terminal Configuration

4.2.1 Main Circuit Terminals (380V AC)

R	S	T		U	V	W
---	---	---	--	---	---	---

 Figure 4.2 Main circuit terminals ($\leq 15\text{KW}$)

R	S	T	U	V	W	
---	---	---	---	---	---	--

 Figure 4.3 Main circuit terminals ($\geq 18.5\text{KW}$)

Main circuit terminal functions are summarized according to the terminal symbols in the following table. Wire the terminal correctly for the desired purposes.

Terminal	Description
R、S、T	Terminals of 3 phase AC input
U、V、W	Terminals of 3 phase AC output
	Terminal of ground

4.2.2 Control Circuit Terminals

S1	S2	S3	S4	S5	HDI1	GND	AI1	AI2	+10V
+24V	PW	COM	Y1	CME	COM	HDO	AO1	GND	PE

RO1A	RO1B	RO1C
RO2A	RO2B	RO2C

Figure 4.4 Control circuit terminals

Descriptions as follow:

Terminal	Description
S1~S5	ON-OFF signal input, optical coupling with PW and COM. Input voltage range: 9~30V Input impedance: 3.3k Ω
HDI1(HDI2)	High speed pulse or ON-OFF signal input, optical coupling with PW and COM. Pulse input frequency range: 0~50kHz Input voltage range: 9~30V Input impedance: 1.1k Ω
PW	External power supply. +24V terminal is connected to PW

Terminal	Description
	terminal as default setting. If user need external power supply, disconnect +24V terminal with PW terminal and connect PW terminal with external power supply.
+24V	Provide output power supply of +24V. Maximum output current: 150mA
AI1 (AI3, AI4)	Analog input, 0~10V Input impedance: 10kΩ
AI2	Analog input, 0~10V/ 0~20mA, switched by J18. Input impedance:10kΩ (voltage input) / 250Ω (current input)
GND	Common ground terminal of analog signal and +10V. GND must isolated from COM.
Y1(Y2)	Open collector output terminal, the corresponding common ground terminal is CME. External voltage range: 0~24V Output current range: 0~50mA
CME	Common terminal of open collector output
COM	Common ground terminal for digital signal and +24V (or external power supply).
+10V	Supply +10V for inverter.Output current range:0~10mA.
HDO	High speed pulse output terminal. The corresponding common ground terminal is COM. Output frequency range: 0~50 kHz
AO1(AO2)	Provide voltage or current output which can be switched by J19. Output range: 0~10V/ 0~20mA
PE	Ground Terminal.
RO1A, RO1B, RO1C	RO1 relay output: RO1A—common; RO1B—NC; RO1C—NO. Contact capacity: AC 250V/3A, DC 30V/1A.
RO2A, RO2B, RO2C	RO2 relay output: RO2A—common; RO2B—NC; RO2C—NO. Contact capacity: AC 250V/3A, DC 30V/1A.
RO3A, RO3B, RO3C	RO3 relay output: RO3A—common; RO3B—NC; RO3C—NO. Contact capacity: AC 250V/3A, DC 30V/1A.

4.2.3 Jumper on control board

Jumper	Description
J2, J4, J5	It is prohibited to be connected together, otherwise it will cause

4.4 Specifications of Breaker, Cable, Contactor and Reactor

4.4.1 Specifications of breaker, cable and contactor

Model No.	Circuit breaker (A)	Input/output cable (mm ²) (Copper wire)	Rated current of contactor (A) (380V or 220V)
3AC 380V ±15%			
CHV110-7R5G-4	40	6	25
CHV110-011G-4	63	6	32
CHV110-015G-4	63	6	50
CHV110-018G-4	100	10	63
CHV110-022G-4	100	16	80
CHV110-030G-4	125	25	95
CHV110-037G-4	160	25	120
CHV110-045G-4	200	35	135
CHV110-055G-4	200	35	170
CHV110-075G-4	250	70	230
CHV110-090G-4	315	70	280
CHV110-110G-4	400	95	315

4.4.2 Specifications of AC input/output and DC reactor

Model No.	AC Input reactor		AC Output reactor		DC reactor	
	Current (A)	Inductance (mH)	Current (A)	Inductance (mH)	Current (A)	Inductance (mH)
3AC 380V ±15%						
CHV110-7R5G-4	20	1	20	0.13	—	—
CHV110-011G-4	30	0.6	30	0.087	—	—
CHV110-015G-4	40	0.6	40	0.066	—	—
CHV110-018G-4	50	0.35	50	0.052	40	1.3
CHV110-022G-4	60	0.28	60	0.045	50	1.08
CHV110-030G-4	80	0.19	80	0.032	65	0.8
CHV110-037G-4	90	0.19	90	0.03	78	0.7
CHV100-045G-4	120	0.13	120	0.023	95	0.54
CHV100-055G-4	150	0.11	150	0.019	115	0.45
CHV100-075G-4	200	0.12	200	0.014	160	0.36

Model No.	AC Input reactor		AC Output reactor		DC reactor	
	Current	Inductance	Current	Inductance	Current	Inductance
	(A)	(mH)	(A)	(mH)	(A)	(mH)
CHV100-090G-4	250	0.06	250	0.011	180	0.33
CHV100-110G-4	250	0.06	250	0.011	250	0.26

4.4.3 Specification of braking unit and braking resistor

Model No.	Braking unit		Braking resistor (100% braking torque)	
	Order No.	Quantity	Specification	Quantity
3AC 380V $\pm 15\%$				
CHV110-7R5G-4	Build-in	1	50 Ω /1040W	1
CHV110-011G-4			40 Ω /1560W	1
CHV110-015G-4				
CHV110-018G-4	DBU-055-4	1	20 Ω /6000W	1
CHV110-022G-4				
CHV110-030G-4				
CHV110-037G-4			13.6 Ω /9600W	1
CHV110-045G-4				
CHV110-055G-4				
CHV110-075G-4	DBU-055-4	2	13.6 Ω /9600W	2
CHV110-090G-4				
CHV110-110G-4				

Notice:

- ⌚ Above selection is based on following condition: 700V DC braking voltage threshold, 100% braking torque and 10% usage rate.
- ⌚ Parallel connection of braking unit is helpful to improve braking capability.
- ⌚ Wire between inverter and braking unit should be less than 5m.
- ⌚ Wire between braking unit and braking resistor should be less than 10m.
- ⌚ Braking unit can be used for braking continuously for 5 minutes. When braking unit is working, temperature of cabinet will be high, user is not allowed to touch to prevent from injury.

For more details, please refer to DBU and RBU user manual.

4.5 Wiring the Main Circuits

4.5.1 Wiring at the side of power supply

- Circuit breaker

It is necessary to connect a circuit breaker which is compatible with the capacity of inverter between 3ph AC power supply and power input terminals (R, S, T). The capacity of breaker is 1.5~2 times than the rated current of inverter. For details, please refer to <Specifications of Breaker, Cable, and Contactor>.

- Contactor

In order to cut off the input power effectively when something is wrong in the system, contactor should be installed at the input side to control the ON-OFF of the main circuit power supply.

- AC reactor

In order to prevent the rectifier damage result from the large current, AC reactor should be installed at the input side. It can also prevent rectifier from sudden variation of power voltage or harmonic generated by phase-control load.

- Input EMC filter

The surrounding device may be disturbed by the cables when the inverter is working. EMC filter can minimize the interference. Just like the following figure.

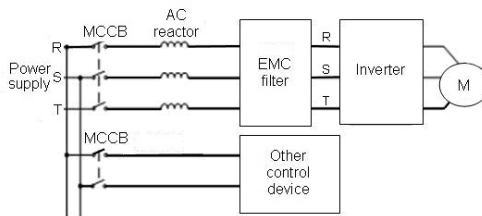

Figure4.6 Wiring at input side.

4.5.2 Wiring for inverter

- DC reactor

Inverters from 18.5kW to 90kW have built-in DC reactor which can improve the power factor,

- Braking unit and braking resistor

- Inverters of 15KW and below have built-in braking unit. In order to dissipate the regenerative energy generated by dynamic braking, the braking resistor should be installed at (+) and PB terminals. The wire length of braking resistor should be less than 5m.

- Inverter of 18.5KW and above need connect external braking unit which should be

installed at (+) and (-) terminals. The cable between inverter and braking unit should be less than 5m. The cable between braking unit and braking resistor should be less than 10m.

- The temperature of braking resistor will increase because the regenerative energy will be transformed to heat. Safety protection and good ventilation is recommended.

Notice: Be sure that the electric polarity of (+) (-) terminals is right; it is not allowed to connect (+) with (-) terminals directly, Otherwise damage or fire could occur.

4.5.3 Wiring at motor side of main circuit

●Output Reactor

When the distance between inverter and motor is more than 50m, inverter may be tripped by over-current protection frequently because of the large leakage current resulted from the parasitic capacitance with ground. And the same time to avoid the damage of motor insulation, the output reactor should be installed.

●Output EMC filter

EMC filter should be installed to minimize the leakage current caused by the cable and minimize the radio noise caused by the cables between the inverter and cable. Just see the following figure.

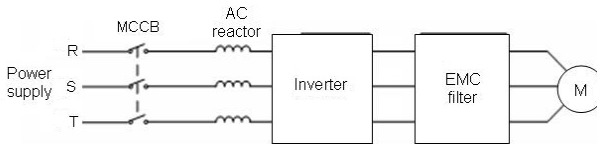

Figure 4.7 Wiring at motor side.

4.5.4 Wiring of regenerative unit

Regenerative unit is used for putting the electricity generated by the brake of motor to the grid. Compared with traditional 3 phase inverse parallel bridge type rectifier unit, IGBT is adopted in regenerative unit so that the total harmonic distortion (THD) is less than 4%. Regenerative unit is widely used for centrifugal and hoisting equipment.

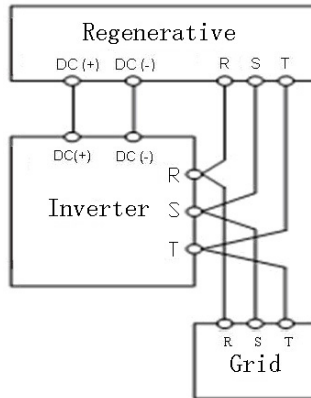

Figure 4.8 Wiring of regenerative unit.

4.5.5 Wiring of Common DC bus

Common DC bus method is widely used in the paper industry and chemical fiber industry which need multi-motor to coordinate. In these applications, some motors are in driving status while some others are in regenerative braking (generating electricity) status. The regenerated energy is automatically balanced through the common DC bus, which means it can supply to motors in driving status. Therefore the power consumption of whole system will be less compared with the traditional method (one inverter drives one motor).

When two motors are running at the same time (i.e. winding application), one is in driving status and the other is in regenerative status. In this case the DC buses of these two inverters can be connected in parallel so that the regenerated energy can be supplied to motors in driving status whenever it needs. Its detailed wiring is shown as follow:

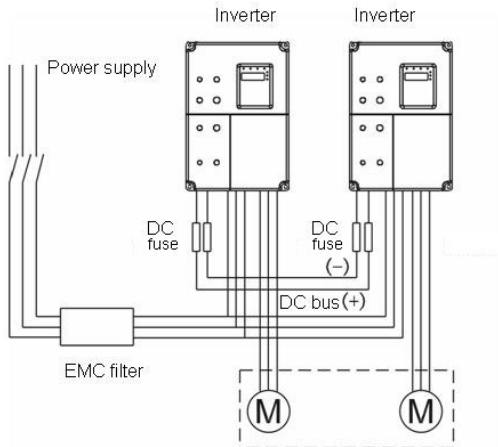

Figure 4.9 Wiring of common DC bus

Notice: Two inverters must be the same model when connected with Common DC bus method. Be sure they are powered on at the same time.

4.5.6 Ground Wiring (PE)

In order to ensure safety and prevent electrical shock and fire, terminal PE must be grounded with ground resistance. The ground wire should be big and short, and it is better to use copper wire ($>3.5\text{mm}^2$). When multiple inverters need to be grounded, do not loop the ground wire.

4.6 Wiring Control Circuit Terminals

4.6.1 Precautions

- I Use shielded or twisted-pair cables to connect control terminals.
- I Connect the ground terminal (PE) with shield wire.
- I The cable connected to the control terminal should leave away from the main circuit and heavy current circuits (including power supply cable, motor cable, relay and contactor connecting cable) at least 20cm and parallel wiring should be avoided. It is suggested to apply perpendicular wiring to prevent inverter malfunction caused by external interference.

4.7 CHV110 installation

4.7.1 Wiring connection

The energy saver connect to power supply cable of injection molding machine in serial, Terminals R,S,T are connected to mains, while U,V,W are connected to injection

molding machine and remove original one.

4.7.2 CHV110 injection molding card

The card is use for sampling pressure and flow signal of the machine and send it to inverter, the card support current and voltage signal.

4.7.3 Special Functions

Functional code P4.12:

If P4.12=0, the power-on terminal control command is invalid;

If P4.12=1, the power-on terminal control command is valid.

4.7.4 Precautions on Wiring

The signal line of the injection molding machine card should be separated from the power line. Parallel wiring is forbidden.

To prevent injection molding machine signals from interference, please select a shielded cable as the signal line of the injection molding machine card.

The shielding layer of the shielded signal line cable of the injection molding machine card should be grounded (such as terminal PE of the inverter), and furthermore, only one end is grounded, to prevent signal interference.

4.8 Installation Guideline to EMC Compliance

4.8.1 General knowledge of EMC

EMC is the abbreviation of electromagnetic compatibility, which means the device or system has the ability to work normally in the electromagnetic environment and will not generate any electromagnetic interference to other equipments.

EMC includes two subjects: electromagnetic interference and electromagnetic anti-jamming.

According to the transmission mode, Electromagnetic interference can be divided into two categories: conducted interference and radiated interference.

Conducted interference is the interference transmitted by conductor. Therefore, any conductors (such as wire, transmission line, inductor, capacitor and so on) are the transmission channels of the interference.

Radiated interference is the interference transmitted in electromagnetic wave, and the energy is inverse proportional to the square of distance.

Three necessary conditions or essentials of electromagnetic interference are: interference source, transmission channel and sensitive receiver. For customers, the solution of EMC problem is mainly in transmission channel because of the device attribute of disturbance source and receiver can not be changed.

4.8.2 EMC features of inverter

Like other electric or electronic devices, inverter is not only an electromagnetic interference source but also an electromagnetic receiver. The operating principle of inverter determines that it can produce certain electromagnetic interference noise. And the same time inverter should be designed with certain anti-jamming ability to ensure the smooth working in certain electromagnetic environment. The following is its EMC features:

- I Input current is non-sine wave. The input current includes large amount of high-harmonic waves that can cause electromagnetic interference, decrease the grid power factor and increase the line loss.
- I Output voltage is high frequency PMW wave, which can increase the temperature rise and shorten the life of motor. And the leakage current will also increase, which can lead to the leakage protection device malfunction and generate strong electromagnetic interference to influence the reliability of other electric devices.
- I As the electromagnetic receiver, too strong interference will damage the inverter and influence the normal using of customers.
- I In the system, EMS and EMI of inverter coexist. Decrease the EMI of inverter can increase its EMS ability.

4.8.3 EMC Installation Guideline

In order to ensure all electric devices in the same system to work smoothly, this section, based on EMC features of inverter, introduces EMC installation process in several aspects of application (noise control, site wiring, grounding, leakage current and power supply filter). The good effective of EMC will depend on the good effective of all of these five aspects.

4.8.3.1 Noise control

All the connections to the control terminals must use shielded wire. And the shield layer of the wire must ground near the wire entrance of inverter. The ground mode is 360 degree annular connection formed by cable clips. It is strictly prohibitive to connect the twisted shielding layer to the ground of inverter, which greatly decreases or loses the shielding effect.

Connect inverter and motor with the shielded wire or the separated cable tray. One side of shield layer of shielded wire or metal cover of separated cable tray should connect to ground, and the other side should connect to the motor cover. Installing an EMC filter can reduce the electromagnetic noise greatly.

4.8.3.2 Site wiring

Power supply wiring: the power should be separated supplied from electrical transformer. Normally it is 5 core wires, three of which are fire wires, one of which is the neutral wire, and one of which is the ground wire. It is strictly prohibitive to use the same line to be both the neutral wire and the ground wire.

Device categorization: there are different electric devices contained in one control cabinet, such as inverter, filter, PLC and instrument etc, which have different ability of emitting and withstanding electromagnetic noise. Therefore, it needs to categorize these devices into strong noise device and noise sensitive device. The same kinds of device should be placed in the same area, and the distance between devices of different category should be more than 20cm.

Wire Arrangement inside the control cabinet: there are signal wire (light current) and power cable (strong current) in one cabinet. For the inverter, the power cables are categorized into input cable and output cable. Signal wires can be easily disturbed by power cables to make the equipment malfunction. Therefore when wiring, signal cables and power cables should be arranged in different area. It is strictly prohibitive to arrange them in parallel or interlacement at a close distance (less than 20cm) or tie them together. If the signal wires have to cross the power cables, they should be arranged in 90 angles. Power input and output cables should not either be arranged in interlacement or tied together, especially when installed the EMC filter. Otherwise the distributed capacitances of its input and output power cable can be coupling each other to make the EMC filter out of function.

4.8.3.3 Ground

Inverter must be ground safely when in operation. Grounding enjoys priority in all EMC methods because it does not only ensure the safety of equipment and persons, but also is the simplest, most effective and lowest cost solution for EMC problems.

Grounding has three categories: special pole grounding, common pole grounding and series-wound grounding. Different control system should use special pole grounding, and different devices in the same control system should use common pole grounding, and different devices connected by same power cable should use series-wound grounding.

4.8.3.4 Leakage Current

Leakage current includes line-to-line leakage current and over-ground leakage current. Its value depends on distributed capacitances and carrier frequency of inverter. The over-ground leakage current, which is the current passing through the common ground wire, can not only flow into inverter system but also other devices. It also can make

leakage current circuit breaker, relay or other devices malfunction. The value of line-to-line leakage current, which means the leakage current passing through distributed capacitors of input output wire, depends on the carrier frequency of inverter, the length and section areas of motor cables. The higher carrier frequency of inverter, the longer of the motor cable and/or the bigger cable section area, the larger leakage current will occur.

Countermeasure:

Decreasing the carrier frequency can effectively decrease the leakage current. In the case of motor cable is relatively long (longer than 50m), it is necessary to install AC reactor or sinusoidal wave filter at the output side, and when it is even longer, it is necessary to install one reactor at every certain distance.

4.8.3.5 EMC Filter

EMC filter has a great effect of electromagnetic decoupling, so it is preferred for customer to install it.

For inverter, noise filter has following categories:

- I Noise filter installed at the input side of inverter.
- I Install noise isolation for other equipment by means of isolation transformer or power filter.

4.8.4 If user install inverter and EMI filter according to the installation guideline, we believe inverter system comply with following compliance.

- I EN61000-6-4
- I EN61000-6-3
- I EN61800-3

5. OPERATION

5.1 Operating Keypad Description

5.1.1 Keypad schematic diagram

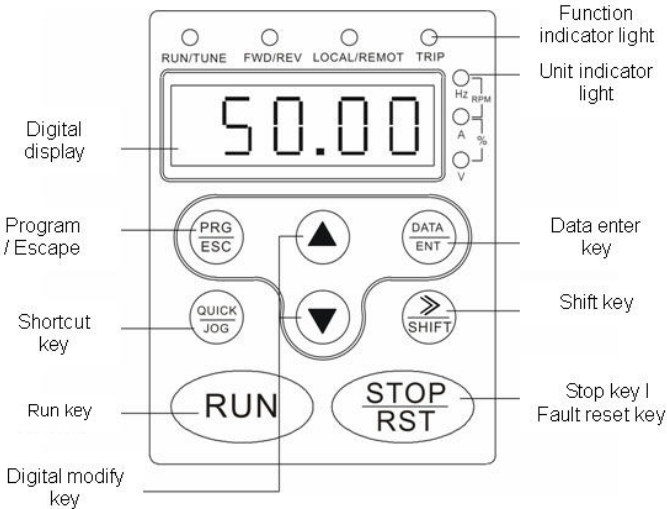

Figure 5.1 Keypad schematic diagram

5.1.2 Button function description

Button	Name	Description
	Programming Key	Entry or escape of first-level menu.
	Enter Key	Progressively enter menu and confirm parameters.
	UP Increment Key	Progressively increase data or function codes.
	DOWN Decrement Key	Progressive decrease data or function codes.
	Shift Key	In parameter setting mode, press this button to select the bit to be modified. In other modes, cyclically displays parameters by right shift

Button	Name	Description
	Run Key	Start to run the inverter in keypad control mode.
	STOP/RESET Key	In running status, restricted by P7.04, can be used to stop the inverter. When fault alarm, can be used to reset the inverter without any restriction.
	Shortcut Key	Determined by Function Code P7.03: 0: Jog operation 1: Switch between forward and reverse 2: Clear the UP/DOWN settings. 3: Quick debugging mode1 (by menu) 4: Quick debugging mode2 (by latest order) 5: Quick debugging mode3 (by non-factory setting parameters)
	Combination Key	Pressing the RUN and STOP/RST at the same time, can achieve inverter coast to stop.

5.1.3 Indicator light description

5.1.3.1 Function Indicator Light Description

Function indicator	Description
	Extinguished: stop status Flickering: parameter autotuning status Light on: operating status
	Extinguished: forward operation Light on: reverse operation.
	Extinguished: keypad control Flickering: terminal control Light on: communication control
	Extinguished: normal operation status Flickering: overload pre-warning status Light on: falut status

5.1.3.2 Unit Indicator Light Description

Unit indicator	Description
Hz	Frequency unit
A	Current unit
V	Voltage unit
RPM	Rotating speed unit
%	Percentage

5.1.3.3 Digital Display

Have 5 digit LED , which can display all kinds of monitoring data and alarm codes such as reference frequency, output frequency and so on.

5.2 Operation Process

5.2.1 Parameter setting

Three levels of menu are:

- I Function code group (first-level);
- I Function code (second-level);
- I Function code value (third-level).

Remarks:

Press both the **PRG/ESC** and the **DATA/ENT** can return to the second-class menu from the third-class menu. The difference is: pressing **DATA/ENT** will save the set parameters into the control panel, and then return to the second-class menu and shift to the next function code automatically; while pressing **PRG/ESC** will directly return to the second-class menu without saving the parameters, and keep staying at the current function code.

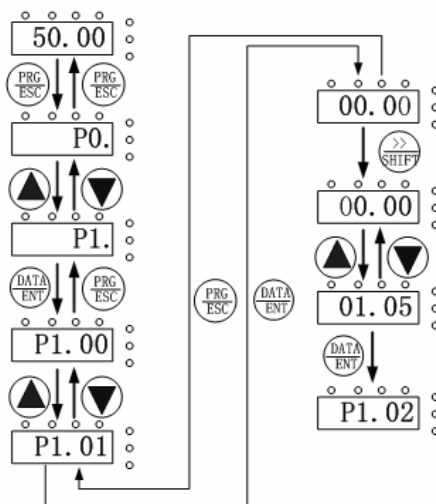

Figure 5.2 Flow chart of parameter setting

Under the third-class menu, if the parameter has no flickering bit, it means the function code can not be modified. The possible reasons could be:

- This function code is not modifiable parameter, such as actual detected parameter, operation records and so on;
- This function code is not modifiable in running status, but is modifiable in stop status.

5.2.2 Shortcut menu setting

Shortcut menu, in which parameters in common use can be programmed, provides a quick way to view and modify function parameters. In the shortcut menu, a parameter being displayed as “hP0.11” means the function parameter P0.11. Modifying parameters in the shortcut menu has the same effect as doing at normal programming status.

Maximum 16 function parameters can be saved into the shortcut menu, and these parameters can be added or deleted when P7.03 is set to be 0.

5.2.3 Shortcut menu operation

Shortcut menu has two levels of menus, which are corresponding to the second-level and the third-level menus of general menu, and has no corresponding with first-level menu.

Remarks:

In stop or running status, press **QUICK/JOG** to enter the shortcut first-level menu, use **UP/DOWN** to select different shortcut parameter, and then press **DATA/ENT** to

enter the shortcut second-level menu. The method to modify parameter at the shortcut second-level menu is the same as that at the general third-level menu. If want to return to last display, press **QUICK/JOG**.

The operation example is as following:

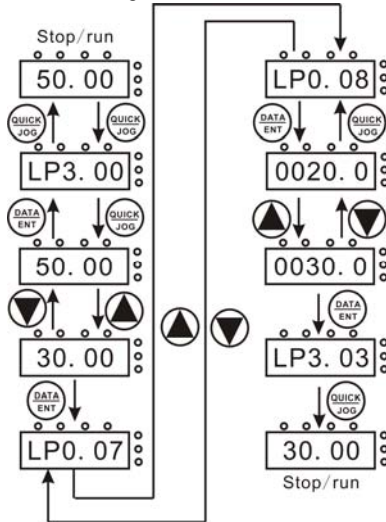

Figure 5.3 Shortcut menu operation.

5.2.4 Fault reset

If the inverter has fault, it will prompt the related fault information. User can use **STOP/RST** or according terminals determined by P5 Group to reset the fault. After fault reset, the inverter is at stand-by state. If user does not reset the inverter when it is at fault state, the inverter will be at operation protection state, and can not run.

5.2.5 Motor parameter autotune

If “Sensorless Vector Control” or “Vector Control with PG” mode is chosen, motor nameplate parameters must be input correctly as the autotuning is based on it. The performance of vector control depends on the parameters of motor strongly, so to achieve excellent performance, firstly must obtain the parameter of motor exactly.

The procedure of motor parameter autotuning is as follows:

Firstly, choose keypad command as the run command source (P0.01).

And then input following parameters according to the actual motor parameters:

- P2.01: motor rated frequency;
- P2.02: motor rated speed;
- P2.03: motor rated voltage;

P2.04: motor rated current

P2.05: motor rated power.

Notice: the motor should be uncoupled with its load; otherwise, the motor parameters obtained by autotuning may be not correct.

Set P0.17 to be 1, and for the detail process of motor parameter autotuning, please refer to the description of Function Code P0.17. And then press **RUN** on the keypad panel, the inverter will automatically calculate following parameter of the motor:

P2.06: motor stator resistance;

P2.07: motor rotor resistance;

P2.08: motor stator and rotor inductance;

P2.09: motor stator and rotor mutual inductance;

P2.10: motor current without load;

then motor autotuning is finished.

5.2.6 Password setting

CHV series inverter offers user's password protection function. When P7.00 is set to be nonzero, it will be the user's password, and After exiting function code edit mode, it will become effective after 1 minute. If pressing the **PRG/ESC** again to try to access the function code edit mode, "----"will be displayed, and the operator must input correct user's password, otherwise will be unable to access it.

If it is necessary to cancel the password protection function, just set P7.00 to be zero.

Notice: Password is not effective for parameters in shortcut menu.

5.3 Running State

5.3.1 Power-on initialization

Firstly the system initializes during the inverter power-on, and LED displays "8888". After the initialization is completed, the inverter is on stand-by status.

5.3.2 Stand-by

At stop or running status, parameters of multi-status can be displayed. Whether or not to display this parameter can be chosen through Function Code P7.06 (Running status display selection) and P7.07 (Stop status display selection) according to binary bits, the detailed description of each bit please refer the function code description of P7.06 and P7.07.

In stop status, there are fourteen parameters which can be chosen to display or not. They are: reference frequency, DC bus voltage, Input-Output terminal status, open collector output status, PID setting, PID feedback, AI1 voltage, AI2 voltage, AI3

voltage/current, AI4 voltage, HDI1 frequency, HDI2 frequency, step number of simple PLC or multi-step speed, length value. Whether or not to display can be determined by setting the corresponding binary bit of P7.07. Press the **» /SHIFT** to scroll through the parameters in right order . Press **DATA/ENT** + **QUICK/JOG** to scroll through the parameters in left order.

5.3.3 Operation

In running status, there are twenty one running parameters which can be chosen to display or not. They are: running frequency, reference frequency, DC bus voltage, output voltage, output current, rotating speed, output power, output torque, PID setting, PID feedback, ON-OFF input status, open collector output status, length value, count value, step number of PLC or multi-step speed, AI1 voltage, AI2 voltage, AI3 voltage/current, AI4 voltage, HDI1 frequency, HDI2 frequency. Whether or not to display can be determined by setting the corresponding binary bit of P7.06. Press the **» /SHIFT** to scroll through the parameters in right order . Press **DATA/ENT** + **QUICK/JOG** to scroll through the parameters in left order.

5.3.4 Fault

In fault status, inverter will display parameters of STOP status besides parameters of fault status. Press the **» /SHIFT** to scroll through the parameters in right order. Press **DATA/ENT** + **QUICK/JOG** to to scroll through the parameters in left order.

5.4 Quick Start

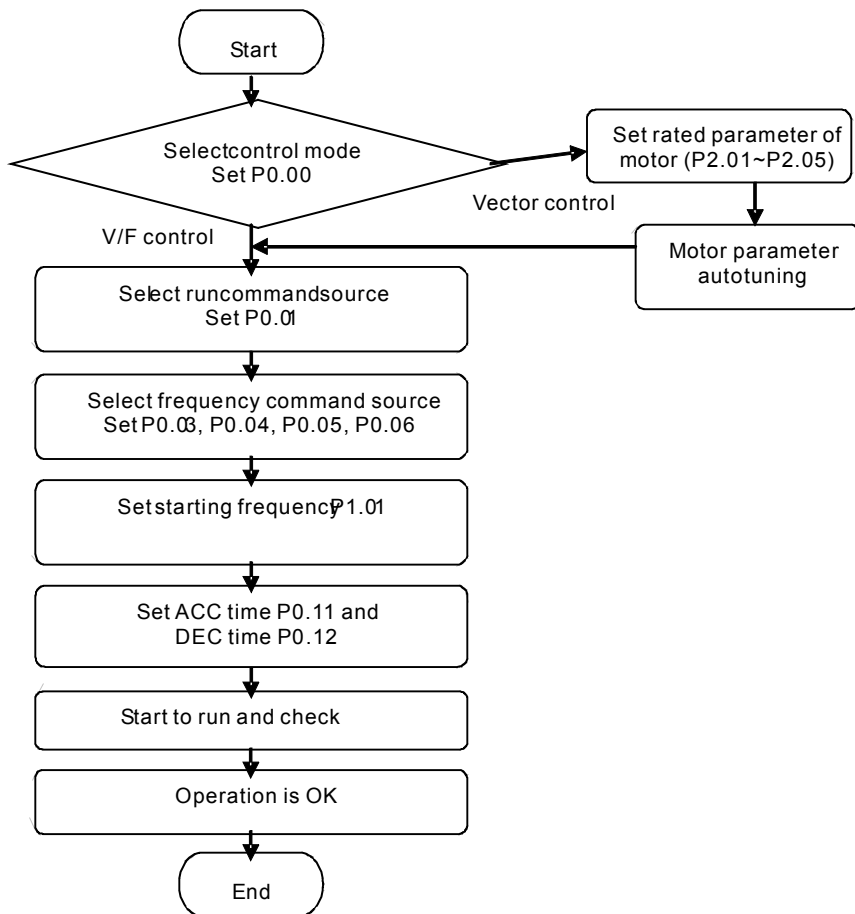

Figure 5.4 Quick start diagram

6. DETAILED FUNCTION DESCRIPTION

6.1 P0 Group--Basic Function

Function Code	Name	Description	Setting Range	Factory Setting
P0.00	Speed control mode	0:Sensorless vector control 1:Vector control With PG 2:V/F control	0~2	0

0: Sensorless vector control: It is widely used for the application which requires high torque at low speed, higher speed accuracy, and quicker dynamic response, such as machine tool, injection molding machine, centrifugal machine and etc.

1: Vector control with PG: Close-loop vector control can achieve high precision speed control and torque control. Therefore it is suitable for the application requiring high accuracy speed and torque, such as textile, paper, lifting and elevator, etc.

If vector control with PG mode is applied, it is needed to equip with PG card and to correctly select and install the encoder.

2: V/F control: It is suitable for general purpose application such as pumps, fans etc.

Notice:

- I Inverter can drive only one motor when P0.00 is set to be 0 or 1. When P0.00 is set to be 2, inverter can drive multi motors.
- I The autotuning of motor parameters must be accomplished properly when P0.00 is set to be 0 or 1.
- I In order to achieve better control characteristic, the parameters of speed regulator (P3.00~P3.05) must be adjusted according to actual situation when P0.00 is set to be 0 or 1.

Function Code	Name	Description	Setting Range	Factory Setting
P0.01	Run command source	0: Keypad (LED extinguished) 1: Terminal (LED flickering) 2: Communication (LED lights on)	0~2	0

The control commands of inverter include: start, stop, forward run, reverse run, jog, fault reset and so on.

0: Keypad (LED extinguished);

Both **RUN** and **STOP/RST** key are used for running command control. If Multifunction

key **QUICK/JOG** is set as FWD/REV switching function (P7.03 is set to be 1), it will be used to change the rotating orientation. **In running status, pressing **RUN** and **STOP/RST** in the same time will cause the inverter coast to stop.**

1: Terminal (LED flickering)

The operation, including forward run, reverse run, forward jog, reverse jog etc. can be controlled by multifunctional input terminals.

2: Communication (LED lights on)

The operation of inverter can be controlled by host through communication.

Function Code	Name	Description	Setting Range	Factory Setting
P0.02	UP/DOWN setting	0:Valid, save UP/DOWN value when power off 1:Valid, do not save UP/DOWN value when power off 2:Invalid 3:Valid during running, clear when power off	0~2	0

0: Valid, save UP/DOWN value when power off.

User can adjust the reference frequency by UP/DOWN. The value of UP/DOWN can be saved when power off.

1: Valid, do not save UP/DOWN value when power off.

User can adjust the reference frequency by UP/DOWN, but the value of UP/DOWN will not be saved when power off.

2: Invalid.

User can not adjust the reference frequency by UP/DOWN. The value of UP/DOWN will be cleared if P0.02 is set to 2.

3: Valid during running, clear when power off

User can adjust the reference frequency by UP/DOWN when inverter is running. When inverter power off, the value of UP/DOWN will be cleared.

Notice:

- I UP/DOWN function can be achieved by keypad (∧ and ∨) and multifunctional terminals.**
- I Reference frequency can be adjusted by UP/DOWN.**
- I UP/DOWN has highest priority which means UP/DOWN is always active no matter which frequency command source is.**

I When the factory setting is restored (P0.18 is set to be 1), the value of UP/DOWN will be cleared.

Function Code	Name	Description	Setting Range	Factory Setting
P0.03	Frequency A command source	0: Keypad 1: AI1 2: AI3 3: HDI1 4: Simple PLC 5: Multi-Step speed 6: PID 7: Communication	0~7	0

0: Keypad: Please refer to description of P0.10

1: AI1

2: AI3

The reference frequency is set by analog input. AI1 is 0~10V voltage input terminal, while AI3 is -10V~10V voltage input.

Notice:

I For detailed relationship between analogue input voltage and frequency, please refer to description of P5.15~P5.19.

I 100% of AI is corresponding to maximum frequency.

3: HDI1

The reference frequency is set by high speed pulse input.

Pulse specification : pulse voltage range 15~30V, and pulse frequency range 0.0~50.0 kHz.

Notice: High speed pulse can only be input through HDI. P5.00 must be set to be 0 (HDI), and P5.35 must be set to be 0 (reference input). For detailed relationship between HDI input and frequency, please refer to description of P5.37~P5.41.

4: Simple PLC

User can set reference frequency, hold time, running direction of each step and acceleration/deceleration time between steps. For details, please refer to description of PA group.

5: Multi-steps speed

The reference frequency is determined by PA group. The selection of steps is determined by combination of multi-step speed terminals.

Notice:

- **Multi-step speed mode will enjoy priority in setting reference frequency if P0.03 is not set to be 4 or 5. In this case, only step 1 to step 15 are available.**
- **If P0.03 is set to be 5, step 0 to step 15 can be realized.**
- **Jog has highest priority.**

6: PID

The reference frequency is the result of PID adjustment. For details, please refer to description of P9 group.

7: Communication

The reference frequency is set through RS485. For details, please refer to operation manual of communication card.

Function Code	Name	Description	Setting Range	Factory Setting
P0.04	Frequency B command source	0:AI2 1:AI4 2:HDI2	0~2	0
P0.05	Scale of frequency B command	0: Maximum frequency 1: Frequency A command	0~1	0

Frequency B command can act as the independent reference frequency source. Moreover, it can also act as offset of frequency A command.

0: AI2.

If P0.05 is set to 0, reference frequency B = AI2 (%) * P0.04 (maximum frequency).

If P0.05 is set to 1, reference frequency B = AI2 (%) * reference frequency A.

Notice: AI2 is percentage of range determined by P5.20~P5.24.

1: AI4.

The principle is the same as AI2.

Notice:

- **AI4 is percentage of range determined by P5.30~P5.34.**
- **When AI2 or AI4 is set as 0~20mA current input, the corresponding voltage range is 0~5V.**

2. HDI2

The principle is the same as AI1.

Code			Range	Setting
P0.06	Frequency command selection	0: A 1: B 2: A+B 3: Max (A, B)	0~3	0

This parameter can be used to select the reference frequency command.

0: Only frequency command source A is active.

1: Only Frequency command source B is active.

2: Both Frequency command source A and B are active.

Reference frequency = reference frequency A + reference frequency B.

3: Both Frequency command source A and B are active.

Reference frequency = Max (reference frequency A, reference frequency B).

Notice: The frequency command source can be selected not only P0.06 but also by multifunctional terminals. Please refer to description of P5 Group.

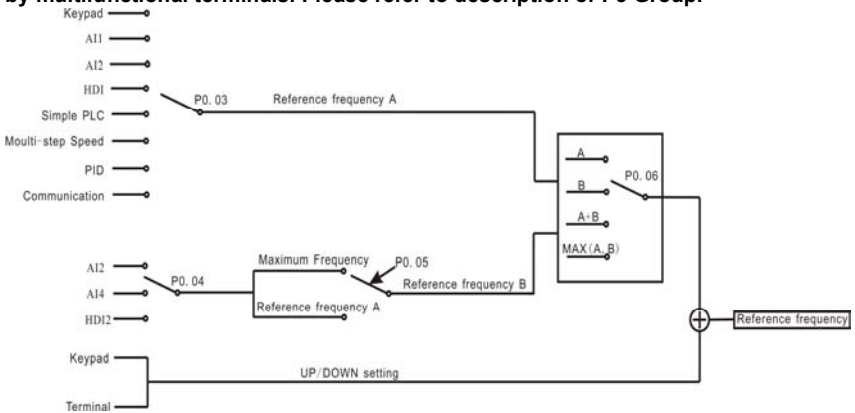

Figure 6.1 Reference frequency diagram.

Function Code	Name	Description	Setting Range	Factory Setting
P0.07	Maximum frequency	10~400.00Hz	10.0~400.00	50.00Hz

Notice:

- I The frequency reference should not exceed maximum frequency.
- I Actual acceleration time and deceleration time are determined by maximum frequency. Please refer to description of P0.11 and P0.12.

Function Code	Name	Description	Setting Range	Factory Setting
P0.08	Upper frequency limit	P0.09~P0.07	P0.09~P0.07	50.00Hz

Notice:

I Upper frequency limit should not be greater than the maximum frequency (P0.07).

I Output frequency should not exceed upper frequency limit.

Function Code	Name	Description	Setting Range	Factory Setting
P0.09	Lower frequency limit	0.00Hz~ P0.08	0.00~P0.08	0.00Hz

Notice:

I Lower frequency limit should not be greater than upper frequency limit (P0.08).

I If frequency reference is lower than P0.09, the action of inverter is determined by P1.14. Please refer to description of P1.14.

Function Code	Name	Description	Setting Range	Factory Setting
P0.10	Keypad reference frequency	0.00 Hz ~ P0.08	0.00~P0.08	50.00Hz

When P0.03 is set to be 0, this parameter is the initial value of inverter reference frequency.

Function Code	Name	Description	Setting Range	Factory Setting
P0.11	Acceleration time 0	0.0~3600.0s	0.0~3600.0	20.0s
P0.12	Deceleration time 0	0.0~3600.0s	0.0~3600.0	20.0s

Acceleration time is the time of accelerating from 0Hz to maximum frequency (P0.07).

Deceleration time is the time of decelerating from maximum frequency (P0.07) to 0Hz.

Please refer to following figure.

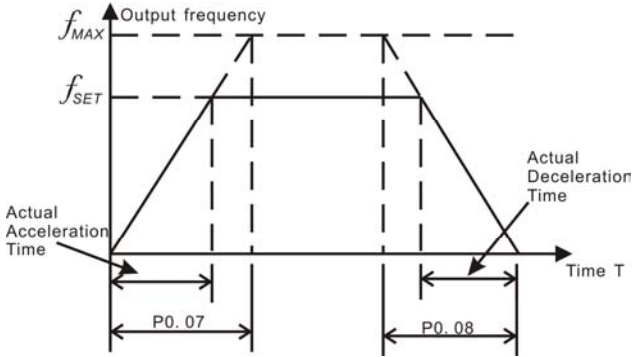

Figure 6.2 Acceleration and Deceleration time.

When the reference frequency is equal to the maximum frequency, the actual acceleration and deceleration time will be equal to the P0.11 and P0.12 respectively. When the reference frequency is less than the maximum frequency, the actual acceleration and deceleration time will be less than the P0.11 and P0.12 respectively. The actual acceleration (deceleration) time = P0.11 (P0.12) * reference frequency/P0.07. CHV series inverter has 4 groups of acceleration and deceleration time.

- 1st group: P0.11, P0.12
- 2nd group: P8.00, P8.01
- 3rd group: P8.02, P8.03
- 4th group: P8.04, P8.05.

The acceleration and deceleration time can be selected by combination of multifunctional ON-OFF input terminals determined by P5 Group. The factory setting of acceleration and deceleration time is as follow:

- ☐ 5.5kW and below: 10.0s
- ☐ 7.5kW~30kW: 20.0s
- ☐ 37kW and above: 40.0s

Function Code	Name	Description	Setting Range	Factory Setting
P0.13	Running direction selection	0: Forward 1: Reverse 2: Forbid reverse	0~2	0

Notice:

- I The rotation direction of motor is corresponding to the wiring of motor.
- I When the factory setting is restored (P0.18 is set to be 1), the rotation

direction of motor may be changed. Please be cautious to use.

- I If P0.13 is set to 2, user can not change rotation direction of motor by **QUICK/JOG** or terminal.

Function Code	Name	Description	Setting Range	Factory Setting
P0.14	Carrier frequency	1.0~16.0kHz	1.0~16.0	Depend on model

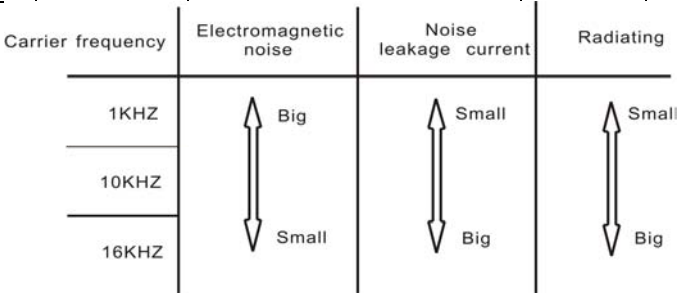

Figure 6.3 Effect of carrier frequency.

Carrier frequency / Model	Highest Carrier Frequency(kHz)	Lowest Carrier Frequency(kHz)	Factory Setting (kHz)
G Model: 1.5kW~11kW	16	1	8
G Model: 15kW~55kW	8	1	4
G Model: 75kW~630kW	6	1	2

Carrier frequency will affect the noise of motor and the EMI of inverter.

If the carrier frequency is increased, it will cause better current wave, less harmonic current and lower noise of motor.

Notice:

- I The factory setting is optimal in most cases. Modification of this parameter is not recommended.
- I If the carrier frequency exceeds the factory setting, the inverter must be derated because the higher carrier frequency will cause more switching loss, higher temperature rise of inverter and stronger electromagnetic interference.
- I If the carrier frequency is lower than the factory setting, it is possible to cause less output torque of motor and more harmonic current.

Function Code	Name	Description	Setting Range	Factory Setting
P0.15	PWM mode	0: Fixed 1: Random	0~1	0

0: Fixed: The noise frequency of motor is fixed.

1: Random: This mode can restrain the noise of motor effectively, but may increase the harmonic of motor.

Function Code	Name	Description	Setting Range	Factory Setting
P0.16	Carrier frequency adjust based on temperature	0: Disabled 1: Enabled	0~1	0

0: Disabled: Carrier frequency is fixed.

1: Enabled: Carrier frequency will be adjusted based on internal temperature of the inverter. The higher the temperature, the lower the carrier frequency.

Function Code	Name	Description	Setting Range	Factory Setting
P0.17	Motor parameters autotuning	0: No action 1: Rotation autotuning 2: Static autotuning	0~2	0

0: No action: Forbidding autotuning.

1: Rotation autotuning:

- ⊣ Do not connect any load to the motor when performing autotuning and ensure the motor is in static status.
- ⊣ Input the nameplate parameters of motor (P2.01~P2.05) correctly before performing autotuning. Otherwise the parameters detected by autotuning will be incorrect; it may influence the performance of inverter.
- ⊣ Set the proper acceleration and deceleration time (P0.11 and P0.12) according to the motor inertia before performing autotuning. Otherwise it may cause over-current and over-voltage fault during autotuning.
- ⊣ The operation process is as follow:
 - a. Set P0.17 to be 1 then press the **DATA/ENT**, LED will display “-TUN-” and flickers. During “-TUN-” is flickering, press the **PRG/ESC** to exit autotuning.

- b. Press the RUN to start the autotuning. LED will display "TUN-0".
- c. After a few seconds the motor will start to run. LED will display "TUN-1" and "RUN/TUNE" light will flicker.
- d. After a few minutes, LED will display "-END-". That means the autotuning is finished and return to the stop status.
- e. During the autotuning, press the **STOP/RST** will stop the autotuning.

Notice: Only keypad can control the autotuning. P0.17 will restore to 0 automatically when the autotuning is finished or cancelled.

2: Static autotuning:

- ⌋ If it is difficult to disconnect the load, static autotuning is recommended.
- ⌋ The operation process is the same as rotation autotuning except step c.

Notice: The Mutual inductance and current without load will not be detected by static autotuning, if needed user should input suitable value according to experience.

Function Code	Name	Description	Setting Range	Factory Setting
P0.18	Restore parameters	0: No action 1: Restore factory setting 2: Clear fault records 3: Restore parameters for injection molding machine	0~3	0

0: No action.

1: Inverter restores all parameters to factory setting except P2 group.

2: Inverter clear all fault records.

3: Inverter restores special parameters for injection molding machine.

This function code will restore to 0 automatically when complete the function operation.

6.2 P1 Group--Start and Stop Control

Function Code	Name	Description	Setting Range	Factory Setting
P1.00	Start Mode	0: Start directly 1: DC braking and start 2: Speed tracking and start	0~2	0

0: Start directly: Start the motor at the starting frequency determined by P1.01.

1: DC braking and start: Inverter will output DC current firstly and then start the motor at

the starting frequency. Please refer to description of P1.03 and P1.04. It is suitable for the motor which have small inertia load and may reverse rotation when start.

2: Speed tracking and start: Inverter detects the rotation speed and direction of motor, then start running to its reference frequency based on current speed. This can realize smooth start of rotating motor with big inertia load when instantaneous power off.

Notice: It only applies on the inverter of 7.5kW and above.

Function Code	Name	Description	Setting Range	Factory Setting
P1.01	Starting frequency	0.00~10.0Hz	0.00~10.00	0.00Hz
P1.02	Hold time of starting frequency	0.0~50.0s	0.0~50.0	0.0s

Set proper starting frequency can increase the starting torque.

If the reference frequency is less than starting frequency, inverter will be at stand-by status. The indicator of RUN/TUNE lights on, inverter has no output.

The starting frequency could be less than the lower frequency limit (P0.09).

P1.01 and P1.02 take no effect during FWD/REV switching.

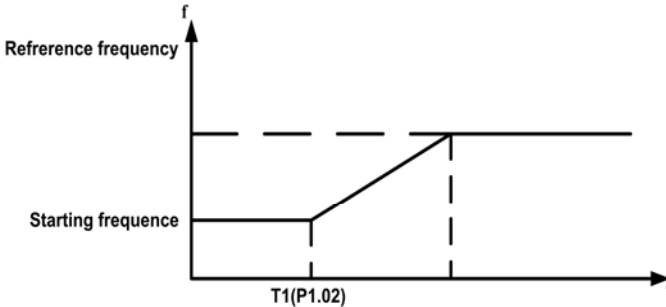

Figure 6.4 Starting diagram.

Function Code	Name	Description	Setting Range	Factory Setting
P1.03	DC Braking current before start	0.0~150.0%	0.0~150.0	0.0%
P1.04	DC Braking time before start	0.0~50.0s	0.0~50.0	0.0s

When inverter starts, it performs DC braking according to P1.03 firstly, then start to accelerate after P1.04.

Notice:

- I DC braking will take effect only when P1.00 is set to be 1.
- I DC braking is invalid when P1.04 is set to be 0.
- I The value of P1.03 is the percentage of rated current of inverter. The bigger the DC braking current, the greater the braking torque.

Function Code	Name	Description	Setting Range	Factory Setting
P1.05	Acceleration /Deceleration mode	0:Linear 1:S curve	0~1	0

0: Linear: Output frequency will increase or decrease with fixed acceleration or deceleration time.

1: S curve: Output frequency will increase or decrease according to S curve. This function is widely used in applications which require smooth start and stop, such as elevators, belt conveyor etc. For details, please refer to description of P1.06 and P1.07.

Notice: CHV inverter offers 4 groups of specific acceleration and deceleration time, which can be determined by the multifunctional ON-OFF input terminals (P5 Group).

Function Code	Name	Description	Setting Range	Factory Setting
P1.06	Start section of S curve	0.0~40.0% (ACC/DEC time)	0.0~40.0	30.0%
P1.07	End section of S curve	0.0~40.0% (ACC/DEC time)	0.0~40.0	30.0%

P1.06 and P1.07 are only active when P1.05=1. During t1 period, the change rate of output frequency increases from 0; During t2 period, the change rate of output frequency decrease to 0; During the period between t1 and t2, the change rate of output frequency remain constant.

The curvature of S curve is codetermined by ACC/DEC time, start section time and end section time.

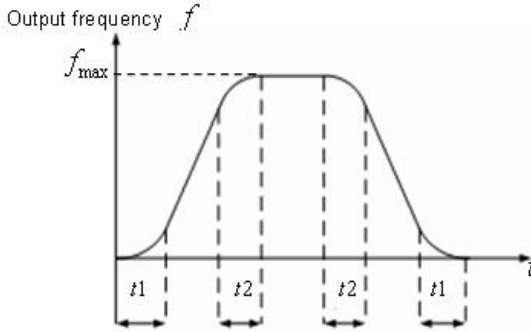

Figure 6.5 S curve diagram.

Function Code	Name	Description	Setting Range	Factory Setting
P1.08	Stop Mode	0:Deceleration to stop 1:Coast to stop	0~1	0

0: Deceleration to stop

When the stop command takes effect, the inverter decreases the output frequency according to P1.05 and the selected acceleration/deceleration time till stop.

1: Coast to stop

When the stop command takes effect, the inverter blocks the output immediately. The motor coasts to stop by its mechanical inertia.

Function Code	Name	Description	Setting Range	Factory Setting
P1.09	Starting frequency of DC braking	0.00~P0.07	0.00~10.00	0.00Hz
P1.10	Waiting time before DC braking	0.0~50.0s	0.0~50.0	0.0s
P1.11	DC braking current	0.0~150.0%	0.0~150.0	0.0%
P1.12	DC braking time	0.0~50.0s	0.0~50.0	0.0s

Starting frequency of DC braking: Start the DC braking when running frequency reaches starting frequency determined by P1.09.

Waiting time before DC braking: Inverter blocks the output before starting the DC braking. After this waiting time, the DC braking will be started. It is used to prevent over-current fault caused by DC braking at high speed.

DC braking current: The value of P1.11 is the percentage of rated current of inverter. The bigger the DC braking current, the greater the braking torque.

DC braking time: The time used to perform DC braking. If the time is 0, the DC braking will be invalid.

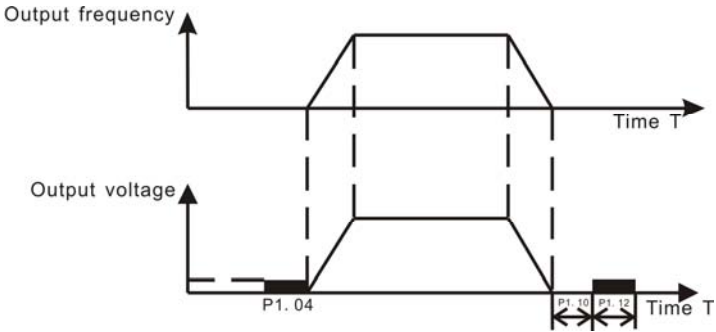

Figure 6.6 DC braking diagram.

Function Code	Name	Description	Setting Range	Factory Setting
P1.13	Dead time of FWD/REV	0.0~3600.0s	0.0~3600.0	0.0s

Set the hold time at zero frequency in the transition between forward and reverse running.

It is shown as following figure:

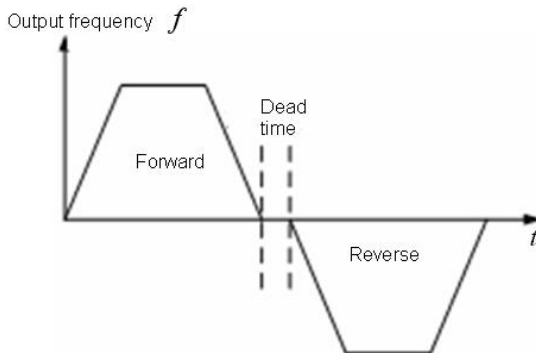

Figure 6.7 FWD/REV dead time diagram.

Function Code	Name	Description	Setting Range	Factory Setting
P1.14	Action when running frequency is less than lower frequency limit	0: Running at the lower frequency limit 1: Stop 2: Stand-by	0~2	0

0: Running at the lower frequency limit (P0.09): The inverter runs at P0.09 when the running frequency is less than P0.09.

1: Stop: This parameter is used to prevent motor running at low speed for a long time.

2: Stand-by: Inverter will stand-by when the running frequency is less than P0.09. When the reference frequency is higher than or equal to P0.09 again, the inverter will start to run automatically.

Function Code	Name	Description	Setting Range	Factory Setting
P1.15	Restart after power off	0: Disabled 1: Enabled	0~1	0
P1.16	Delay time for restart	0.0~3600.0s	0.0~3600.0	0.0s

0: Disabled: Inverter will not automatically restart when power on again until run command takes effect.

1: Enabled: When inverter is running, after power off and power on again, if run command source is keypad control (P0.01=0) or communication control (P0.01=2), inverter will automatically restart after delay time determined by P1.16; if run command source is terminal control (P0.01=1), inverter will automatically restart after delay time determined by P1.16 only if FWD or REV is active.

Notice:

- I If P1.15 is set to be 1, it is recommended that start mode should be set as speed tracing mode (P1.00=2).
- I This function may cause the inverter restart automatically, please be cautious.

6.3 P2 Group--Motor Parameters

Function Code	Name	Description	Setting Range	Factory Setting
P2.00	Inverter Model	0:G model 1: P model	0~1	0

0: Applicable to constant torque load

1: Applicable to variable torque load such as pumps and fans.

Function Code	Name	Description	Setting Range	Factory Setting
P2.01	Motor rated frequency	0.01Hz~P0.07	0.01~P0.07	50.00Hz
P2.02	Motor rated speed	0~36000rpm	0~36000	1460rpm
P2.03	Motor rated voltage	0~3000V	0~3000	Depend on model
P2.04	Motor rated current	0.1~2000.0A	0.1~2000.0	Depend on model
P2.05	Motor rated power	1.5~900.0kW	1.5~900.0	Depend on model

Notice:

- I In order to achieve superior performance, please set these parameters according to motor nameplate, then perform autotuning.
- I The power rating of inverter should match the motor. If the bias is too big, the control performances of inverter will be deteriorated distinctly.
- I Reset P2.05 can initialize P2.06~P2.10 automatically.

Function Code	Name	Description	Setting Range	Factory Setting
P2.06	Motor stator resistance	0.001~65.535Ω	0.001~65.535	Depend on model
P2.07	Motor rotor resistance	0.001~65.535Ω	0.001~65.535	Depend on model
P2.08	Motor leakage inductance	0.1~6553.5mH	0.1~6553.5	Depend on model
P2.09	Motor mutual inductance	0.1~6553.5mH	0.1~6553.5	Depend on model

Function Code	Name	Description	Setting Range	Factory Setting
P2.10	Current without load	0.01~655.35A	0.01~655.35	Depend on model

After autotuning, the value of P2.06~P2.10 will be automatically updated.

Notice: Do not change these parameters, otherwise it may deteriorate the control performance of inverter.

6.4 P3 Group--Vector Control

Function Code	Name	Description	Setting Range	Factory Setting
P3.00	ASR proportional gain K_p1	0~100	0~100	20
P3.01	ASR integral time K_i1	0.01~10.00s	0.01~10.00	0.50s
P3.02	ASR switching point 1	0.00Hz~P3.05	0.00~P3.05	5.00Hz
P3.03	ASR proportional gain K_p2	0~100	0~100	25
P3.04	ASR integral time K_i2	0.01~10.00s	0.01~10.00	1.00s
P3.05	ASR switching point 2	P3.02~P0.07	P3.02~P0.07	10.00Hz

P3.00~P3.05 are only valid for vector control and torque control and invalid for V/F control. Through P3.00~P3.05, user can set the proportional gain K_p and integral time K_i of speed regulator (ASR), so as to change the speed response characteristic. ASR's structure is shown in following figure.

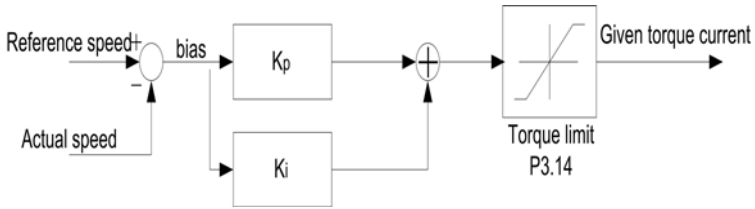

Figure 6.8 ASR diagram.

P3.00 and P3.01 only take effect when output frequency is less than P3.02. P3.03 and P3.04 only take effect when output frequency is greater than P3.05. When output frequency is between P3.02 and P3.05, K_p and K_i are proportional to the bias between P3.02 and P3.05. For details, please refer to following figure.

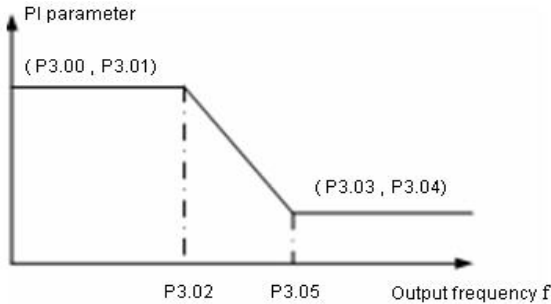

Figure 6.9 PI parameter diagram.

The system's dynamic response can be faster if the proportion gain K_p is increased; However, if K_p is too large, the system tends to oscillate.

The system dynamic response can be faster if the integral time K_i is decreased; However, if K_i is too small, the system becomes overshoot and tends to oscillate.

P3.00 and P3.01 are corresponding to K_p and K_i at low frequency, while P3.03 and P3.04 are corresponding to K_p and K_i at high frequency. Please adjust these parameters according to actual situation. The adjustment procedure is as follow:

- ⊣ Increase the proportional gain (K_p) as far as possible without creating oscillation.
- ⊣ Reduce the integral time (K_i) as far as possible without creating oscillation.

For more details about fine adjustment, please refer to description of P9 group.

Function Code	Name	Description	Setting Range	Factory Setting
P3.06	ACR proportional gain P	0~65535	0~65535	500

Function Code	Name	Description	Setting Range	Factory Setting
P3.07	ACR integral gain I	0~65535	0~65535	500

The bigger the proportional gain P, the faster the response, but oscillation may easily occur. If only proportional gain P is applied in regulation, the bias cannot be eliminated. In order to eliminate the bias, apply the integral gain I to achieve PI regulator.

Function Code	Name	Description	Setting Range	Factory Setting
P3.08	Speed detection filter time	0.00~5.00s	0.00~5.00	0.00s

The noise along with speed detection signals can be filtered by setting the time constant of filter (P3.08). The bigger the time constant, the better the immunity capability, but the response becomes slow, vice versa.

Function Code	Name	Description	Setting Range	Factory Setting
P3.09	Slip compensation rate of VC	50.0~200.0%	50~100	100%

The parameter is used to adjust the slip frequency of vector control and improve the precision of speed control. Properly adjusting this parameter can effectively restrain the static speed bias.

Function Code	Name	Description	Setting Range	Factory Setting
P3.10	PG parameter	1~65535	1~65535	1000
P3.11	PG direction selection	0: Forward 1: Reverse	0~1	0

P3.10 defines the number of pulse per cycle of PG or encoder.

Notice: When P0.00 is set to be 1, P3.10 must be set correctly according to the encoder parameter, otherwise the motor will run abnormally. If the motor still run abnormally when P3.10 has been set correctly, please change the PG direction (P3.11).

Function Code	Name	Description	Setting Range	Factory Setting
P3.12	Torque setting source	0:Disabled 1: Keypad 2:A11 3:A12 4:A13 5:A14 6:HDI1 7:HDI2 8:Communication	0~8	0
P3.13	Keypad torque setting	-100.0%~100.0%	-100.0%~100.0%	50.0%
P3.14	Torque limit	0.0~200.0%	0.0~200.0	150.0%

0: Torque control is disabled. Inverter will run at speed control mode. Output torque of inverter which should not greater than torque limit (P3.14) matches the torque of load automatically. When the torque of load is greater than torque limit, output torque will remain as torque limit and output frequency will decrease automatically.

1~8: Torque control is enabled.

⌚ When torque control takes effect,

if $T_{set} > T_{load}$, output frequency will increase continuously until it reaches upper frequency limit.

If $T_{set} < T_{load}$, output frequency will decrease continuously until it reaches lower frequency limit.

Inverter can run at any frequency between upper and lower frequency limit only when $T_{set} = T_{load}$.

⌚ Torque control can be switched to speed control, vice versa.

Switching by multifunctional terminal: For example, if torque setting source is A11 (P3.12=2), the value of multifunction terminal S5 is set to 31 (Disable torque control). When S5 is valid, control mode will switch from torque control to speed control, vice versa.

When running at torque control mode, press **STOP/RST**, it will switch to speed control automatically.

⌚ If torque setting is positive, inverter will run forward; otherwise it will run reverse.

Notice:

- I When running at torque control mode, the acceleration time has nothing to do with P0.11.
- I The 100% of torque setting is corresponding to 100% of P3.14 (Torque limit). For example, if torque setting source is keypad (P3.12=1), P3.13=80% and P3.14=90%, then actual torque setting = 80% (P3.13) * 90% (P3.14) = 72%.

6.5 P4 Group --V/F Control

Function Code	Name	Description	Setting Range	Factory Setting
P4.00	V/F curve selection	0:Linear curve 1: User-defined curve 2: Torque_stepdown curve (1.3 order) 3: Torque_stepdown curve (1.7 order) 4: Torque_stepdown curve (2.0 order)	0~4	0

0: Linear curve. It is applicable for normal constant torque load.

1: User-defined curve. It can be defined through setting (P4.03~P4.08).

2~4: Torque_stepdown curve. It is applicable for variable torque load, such as blower, pump and so on. Please refer to following figure.

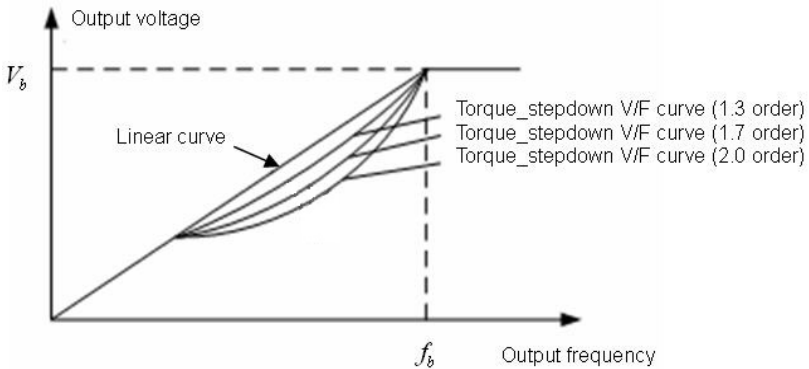

Figure 6.10 Multiple V/F curve diagram.

Function Code	Name	Description	Setting Range	Factory Setting
P4.01	Torque boost	0.0%: auto	0.0~10.0	1.0%

Function Code	Name	Description	Setting Range	Factory Setting
		0.1%~10.0%		
P4.02	Torque boost cut-off	0.0%~50.0% (motor rated frequency)	0.0~50.0	20.0%

Torque boost will take effect when output frequency is less than cut-off frequency of torque boost (P4.02). Torque boost can improve the torque performance of V/F control at low speed.

The value of torque boost should be determined by the load. The heavier the load, the larger the value.

Notice: This value should not be too large, otherwise the motor would be over-heat or the inverter would be tripped by over-current or over-load.

If P4.01 is set to 0, the inverter will boost the output torque according to the load automatically. Please refer to following diagram.

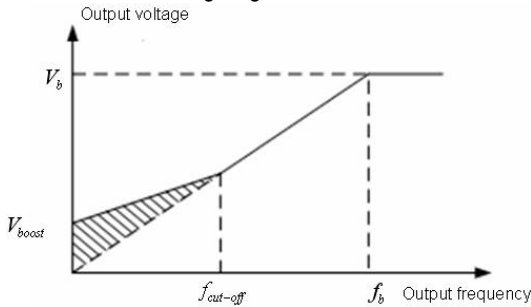

Figure 6.11 Torque boost diagram.

Function Code	Name	Description	Setting Range	Factory Setting
P4.03	V/F frequency 1	0.00Hz~ P4.05	0.00~P4.05	5.00Hz
P4.04	V/F voltage 1	0.0%~100.0%	0.0~100.0	10.0%
P4.05	V/F frequency 2	P4.03~ P4.07	P4.03~ P4.07	30.00Hz
P4.06	V/F voltage2	0.0%~100.0%	0.0~100.0	60.0%
P4.07	V/F frequency 3	P4.05~ P2.01	P4.05~ P2.01	50.00Hz
P4.08	V/F voltage 3	0.0%~100.0%	0.0~100.0	100.0%

This function is only active when P4.00 is set to be 1. P4.03~P4.08 are used to set the

user-defined V/F curve. The value should be set according to the load characteristic of motor.

Notice:

- I $0 < V1 < V2 < V3 < \text{rated voltage}$.
- I $0 < f1 < f2 < f3 < \text{rated frequency}$.
- I The voltage corresponding to low frequency should not be set too high, otherwise it may cause motor overheat or inverter fault

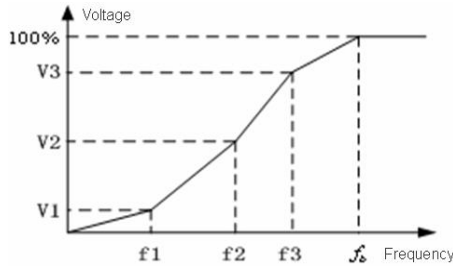

Figure 6.12 V/F curve setting diagram.

Function Code	Name	Description	Setting Range	Factory Setting
P4.09	V/F slip compensation	0.00~10.00Hz	0.00~10.00	0.0Hz

The motor's slip changes with the load torque, which results in the variance of motor speed. The inverter's output frequency can be adjusted automatically through slip compensation according to the load torque. Therefore the change of speed due to the load change can be reduced. The value of compensated slip is dependent on the motor's rated slip which can be calculated as below:

$$P4.09 = f_b - n * P / 60$$

Where f_b is motor rated frequency (P2.01), n is motor rated speed (P2.02), and P is pole pairs of motor.

Function Code	Name	Description	Setting Range	Factory Setting
P4.10	AVR function	0: Disabled 1: Enabled all the time 2: Disabled during deceleration	0~2	1

AVR (Auto Voltage Regulation) function ensure the output voltage of inverter stable no matter how the DC bus voltage changes. During deceleration, if AVR function is disabled,

the deceleration time will be short but the current will be big. If AVR function is enabled all the time, the deceleration time will be long but the current will be small.

Function Code	Name	Description	Setting Range	Factory Setting
P4.11	Auto energy saving selection	0: Disabled 1: Enabled	0~1	0

When P4.11 is set to be 1, while there is a light load, it will reduce the inverter output voltage and saves energy.

Function Code	Name	Description	Setting Range	Factory Setting
P4.12	FWD/REV enable option when power on	0: Disabled 1: Enabled	0~1	0

Notice:

- I This function only takes effect if run command source is terminal control.
- I If P4.12 is set to be 0, when power on, inverter will not start even if FWD/REV terminal is active, until FWD/REV terminal disabled and enabled again.
- I If P4.12 is set to be 1, when power on and FWD/REV terminal is active, inverter will start automatically.
- I This function may cause the inverter restart automatically, please be cautious.

6.6 P5 Group--Input Terminals

Function Code	Name	Description	Setting Range	Factory Setting
P5.00	HDI selection	0: HDI1 and HDI2 are high speed pulse input. 1: HDI1 is ON-OFF input, HDI2 is high speed pulse input. 2: HDI2 is ON-OFF input, HDI1 is high speed pulse input. 3: HDI1 and HDI2 are ON-OFF input.	0~3	0

Please refer to description of HDI in P0.03.

Function Code	Name	Description	Setting Range	Factory Setting
P5.01	Input selection	0: Concrete 1: Virtual	0~1	0

0: ON-OFF signal is input through external input terminals.

1: ON-OFF signal is set through serial communication by host device.

Function Code	Name	Description	Setting Range	Factory Setting
P5.02	S1 Terminal function	Programmable multifunction terminal	0~55	1
P5.03	S2 Terminal function	Programmable multifunction terminal	0~55	4
P5.04	S3 Terminal function	Programmable multifunction terminal	0~55	7
P5.05	S4 Terminal function	Programmable multifunction terminal	0~55	0
P5.06	S5 Terminal function	Programmable multifunction terminal	0~55	0
P5.07	HDI1 terminal function	Programmable multifunction terminal	0~55	0
P5.08	HDI2 terminal function	Programmable multifunction terminal	0~55	0
P5.09	S6 Terminal function	Programmable multifunction terminal	0~55	0
P5.10	S7 Terminal function	Programmable multifunction terminal	0~55	0
P5.11	S8 Terminal function	Programmable multifunction terminal	0~55	0

Notice: P5.07 is only used when P5.00 is set to be 1 or 3. P5.08 is only used when P5.00 is set to be 2 or 3.

The meaning of each setting is shown in following table.

Setting value	Function	Description
0	Invalid	Please set unused terminals to be invalid to avoid

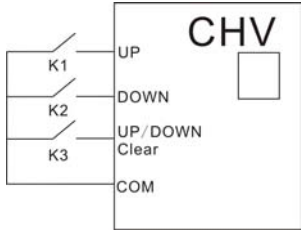
Setting value	Function	Description																	
		malfunction.																	
1	Forward	Please refer to description of P5.13.																	
2	Reverse																		
3	3-wire control	Please refer to description of P5.13.																	
4	Jog forward	Please refer to description of P8.06~P8.08.																	
5	Jog reverse																		
6	Coast to stop	The inverter blocks the output immediately. The motor coasts to stop by its mechanical inertia.																	
7	Reset fault	Resets faults that have occurred. It has the same function as <u>STOP/RST</u> .																	
8	Pause running	When this terminal takes effect, inverter decelerates to stop and save current status, such as PLC, traverse frequency and PID. When this terminal takes no effect, inverter restores the status before pause.																	
9	External fault input	Stop the inverter and output a alarm when a fault occurs in a peripheral device.																	
10	Up command	<p>The reference frequency of inverter can be adjusted by UP command and DOWN command.</p> 																	
11	DOWN command																		
12	Clear UP/DOWN		Use this terminal to clear UP/DOWN setting. Please refer to description of P0.02.																
13	Switch between A and B	<table border="1"> <tr> <td rowspan="4">Terminal action</td> <td>P0.06</td> <td>A</td> <td>B</td> <td>A+B</td> </tr> <tr> <td>13 valid</td> <td>B</td> <td>A</td> <td></td> </tr> <tr> <td>14 valid</td> <td>A+B</td> <td></td> <td>A</td> </tr> <tr> <td>15 valid</td> <td></td> <td>A+B</td> <td>B</td> </tr> </table>	Terminal action	P0.06	A	B	A+B	13 valid	B	A		14 valid	A+B		A	15 valid		A+B	B
Terminal action	P0.06			A	B	A+B													
	13 valid			B	A														
	14 valid			A+B		A													
	15 valid		A+B	B															
14	Switch between A and A+B																		
15	Switch																		

Setting value	Function	Description															
	between B and A+B																
16	Multi-step speed reference1	16 steps speed control can be realized by the combination of these four terminals. For details, please refer to following multi-step speed reference terminal status and according step value table: Such as: 0000: select the multi-speed 0; 1111: multi-speed 15. Notice: multi-speed 1 is low bit, and multi-speed 4 is high bit.															
17	Multi-step speed reference 2																
18	Multi-step speed reference 3																
19	Multi-step speed reference 4																
		<table border="1"> <thead> <tr> <th>Multi-speed terminal 4</th> <th>Multi-speed terminal 3</th> <th>Multi-speed terminal 2</th> <th>Multi-speed terminal 1</th> </tr> </thead> <tbody> <tr> <td>BIT3</td> <td>BIT2</td> <td>BIT1</td> <td>BIT0</td> </tr> </tbody> </table>	Multi-speed terminal 4	Multi-speed terminal 3	Multi-speed terminal 2	Multi-speed terminal 1	BIT3	BIT2	BIT1	BIT0							
Multi-speed terminal 4	Multi-speed terminal 3	Multi-speed terminal 2	Multi-speed terminal 1														
BIT3	BIT2	BIT1	BIT0														
20	Multi-step speed pause	Can shield the function of multi-speed terminals and keep the set value as the current status.															
21	ACC/DEC time selection1	4 groups of ACC/DEC time can be selected by the combination of these two terminals. <table border="1"> <thead> <tr> <th>ACC/DEC time selection 2</th> <th>ACC/DEC time selection1</th> <th>ACC/DEC time</th> </tr> </thead> <tbody> <tr> <td>OFF</td> <td>OFF</td> <td>ACC/DEC time 0 (P0.11、P0.12)</td> </tr> <tr> <td>OFF</td> <td>ON</td> <td>ACC/DEC time 1 (P8.00、P8.01)</td> </tr> <tr> <td>ON</td> <td>OFF</td> <td>ACC/DEC time 2 (P8.02、P8.03)</td> </tr> <tr> <td>ON</td> <td>ON</td> <td>ACC/DEC time 3 (P8.04、P8.05)</td> </tr> </tbody> </table>	ACC/DEC time selection 2	ACC/DEC time selection1	ACC/DEC time	OFF	OFF	ACC/DEC time 0 (P0.11、P0.12)	OFF	ON	ACC/DEC time 1 (P8.00、P8.01)	ON	OFF	ACC/DEC time 2 (P8.02、P8.03)	ON	ON	ACC/DEC time 3 (P8.04、P8.05)
ACC/DEC time selection 2	ACC/DEC time selection1	ACC/DEC time															
OFF	OFF	ACC/DEC time 0 (P0.11、P0.12)															
OFF	ON	ACC/DEC time 1 (P8.00、P8.01)															
ON	OFF	ACC/DEC time 2 (P8.02、P8.03)															
ON	ON	ACC/DEC time 3 (P8.04、P8.05)															
22	ACC/DEC time selection 2																
23	Reset simple PLC when stop	When simple PLC stops, the status of PLC such as running step, running time and running frequency will be cleared when this terminal is enabled.															
24	Pause simple	Inverter runs at zero frequency and PLC pauses the															

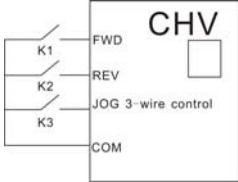
Setting value	Function	Description																		
	PLC	timing when this terminal is enabled. If this terminal is disabled, inverter will start and continue the PLC operation from the status before pause.																		
25	Pause PID	PID adjustment will be paused and inverter keeps output frequency unchanged.																		
26	Pause traverse operation	Inverter keeps output frequency unchanged. If this terminal is disabled, inverter will continue traverse operation from current frequency.																		
27	Reset traverse operation	Reference frequency of inverter will be forced as center frequency of traverse operation.																		
28	Reset counter	Clear the value of counter.																		
29	Reset length	Clear the value of actual length (P8.20).																		
30	ACC/DEC ramp hold	Pauses acceleration or deceleration and maintains output frequency. When this terminal is disabled, acceleration/deceleration is restarted.																		
31	Disable torque control	Torque control is disabled. Inverter will work in speed control mode.																		
32~52	Reserved	Reserved for water supply control.																		
53	3-wire jog control	<p>Combine with FWD/REV operation to be 3-wire jog control.</p>  <table border="1" data-bbox="409 1161 912 1359"> <thead> <tr> <th>K1</th> <th>K2</th> <th>K3</th> <th>Command</th> </tr> </thead> <tbody> <tr> <td>ON</td> <td>OFF</td> <td rowspan="2">OFF</td> <td>Forward running</td> </tr> <tr> <td>OFF</td> <td>ON</td> <td>Reverse running</td> </tr> <tr> <td>ON</td> <td>OFF</td> <td rowspan="2">ON</td> <td>Forward jogging</td> </tr> <tr> <td>OFF</td> <td>ON</td> <td>Reverse jogging</td> </tr> </tbody> </table>	K1	K2	K3	Command	ON	OFF	OFF	Forward running	OFF	ON	Reverse running	ON	OFF	ON	Forward jogging	OFF	ON	Reverse jogging
K1	K2	K3	Command																	
ON	OFF	OFF	Forward running																	
OFF	ON		Reverse running																	
ON	OFF	ON	Forward jogging																	
OFF	ON		Reverse jogging																	
54~55	Reserved	Reserved																		

Function Code	Name	Description	Setting Range	Factory Setting
P5.12	ON-OFF filter times	1~10	1~10	5

This parameter is used to set filter strength of terminals (S1~S8,HDI1,HDI2). When interference is heavy, user should increase this value to prevent malfunction.

Function Code	Name	Description	Setting Range	Factory Setting
P5.13	FWD/REV control mode	0: 2-wire control mode 1 1: 2-wire control mode 2 2: 3-wire control mode 1 3: 3-wire control mode 2	0~3	0

This parameter defines four different control modes that control the inverter operation through external terminals.

0: 2-wire control mode 1: Integrate START/STOP command with run direction.

K1	K2	Run command
OFF	OFF	Stop
ON	OFF	FWD
OFF	ON	REV
ON	ON	Stop

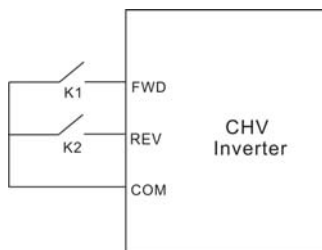

Figure 6.13 2-wire control mode 1.

1: 2-wire control mode 2: START/STOP command is determined by FWD terminal. Run direction is determined by REV terminal.

K1	K2	Run command
OFF	OFF	Stop
ON	OFF	FWD
OFF	ON	Stop
ON	ON	REV

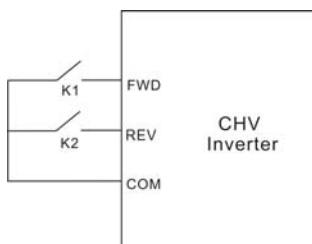

Figure 6.14 2-wire control mode 2.

2: 3-wire control mode 1: SB1: Start button. SB2: Stop button (NC), K: Run direction button, Terminal SIn is the multifunctional input terminal of S1~S8, HDI1 and HDI2. The

terminal function should be set to be 3 (3-wire control).

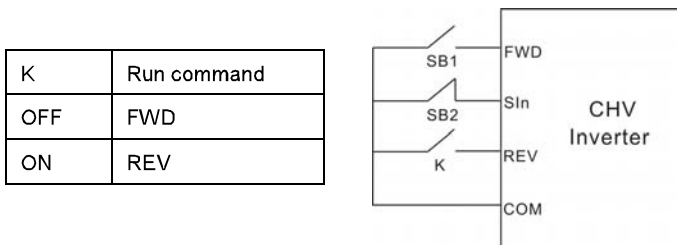

Figure 6.15 3-wire control mode 1.

3: 3-wire control mode 2:

SB1: Forward run button

SB2: Stop button (NC)

SB3: Reverse run button

Terminal SIn is the multifunctional input terminal of S1~S8, HDI1 and HDI2. The terminal function should be set to be 3 (3-wire control).

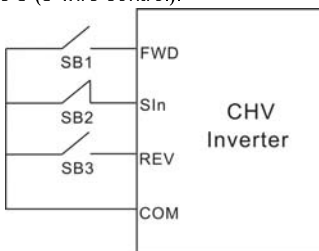

Figure 6.16 3-wire control mode 2.

Notice:

- When 2-wire control mode is active, the inverter will not run in following situation even if FWD/REV terminal is enabled:
- Coast to stop (press RUN and STOP/RST at the same time).
- Stop command from serial communication.
- FWD/REV terminal is enabled before power on. Please refer to description of P4.12.

Function Code	Name	Description	Setting Range	Factory Setting
P5.14	UP/DOWN setting change rate	0.01~50.00Hz/s	0.01~50.00	0.50Hz/s

This parameter is used to determine how fast UP/DOWN setting changes.

Function Code	Name	Description	Setting Range	Factory Setting
P5.15	AI1 lower limit	0.00V~10.00V	0.00~10.00	0.00V
P5.16	AI1 lower limit corresponding setting	-100.0%~100.0%	-100.0~100.0	0.0%
P5.17	AI1 upper limit	0.00V~10.00V	0.00~10.00	10.00V
P5.18	AI1 upper limit corresponding setting	-100.0%~100.0%	-100.0~100.0	100.0%
P5.19	AI1 filter time constant	0.00s~10.00s	0.00~10.00	0.10s

These parameters determine the relationship between analog input voltage and the corresponding setting value. When the analog input voltage exceeds the range between lower limit and upper limit, it will be regarded as the upper limit or lower limit.

The analog input AI1 can only provide voltage input, and the range is 0V~10V.

For different applications, the corresponding value of 100.0% analog setting is different.

For details, please refer to description of each application.

Notice: AI1 lower limit must be less or equal to AI1 upper limit.

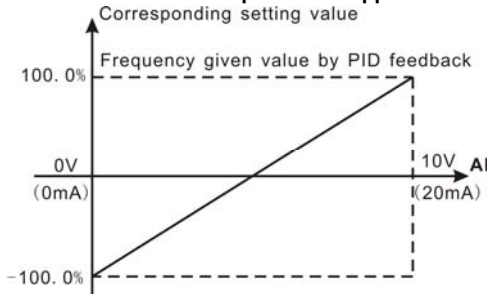

Figure 6.17 Relationship between AI and corresponding setting.

Function Code	Name	Description	Setting Range	Factory Setting
P5.20	AI2 lower limit	0.00V~10.00V	0.00~10.00	0.00V
P5.21	AI2 lower limit corresponding setting	-100.0%~100.0%	-100.0~100.0	0.0%
P5.22	AI2 upper limit	0.00V~10.00V	0.00~10.00	5.00V

Function Code	Name	Description	Setting Range	Factory Setting
P5.23	AI2 upper limit corresponding setting	-100.0%~100.0%	-100.0~100.0	100.0%
P5.24	AI2 filter time constant	0.00s~10.00s	0.00~10.00	0.10s
P5.25	AI3 lower limit	-10.00V ~10.00V	-10.00~10.00	0.00V
P5.26	AI3 lower limit corresponding setting	-100.0%~100.0%	-100.0~100.0	0.0%
P5.27	AI3 upper limit	-10.00V ~10.00V	-10.00~10.00	10.00V
P5.28	AI3 upper limit corresponding setting	-100.0%~100.0%	-100.0~100.0	100.0%
P5.29	AI3 filter time constant	0.00s~10.00s	0.00~10.00	0.10s
P5.30	AI4 lower limit	0.00V~10.00V	0.00~10.00	0.00V
P5.31	AI4 lower limit corresponding setting	-100.0%~100.0%	-100.0~100.0	0.0%
P5.32	AI4 upper limit	0.00V~10.00V	0.00~10.00	10.00V
P5.33	AI4 upper limit corresponding setting	-100.0%~100.0%	-100.0~100.0	100.0%
P5.34	AI4 filter time constant	0.00s~10.00s	0.00~10.00	0.10s

Please refer to description of AI1.

Notice: When AI2 is set as 0~20mA current input, the corresponding voltage range is 0~5V.

Function Code	Name	Description	Setting Range	Factory Setting
P5.35	HDI1 function selection	0: Reference input 1: Counter input	0~4	0
P5.36	HDI2 function	2: Length input	0~4	0

Function Code	Name	Description	Setting Range	Factory Setting
	selection	3: Reserved 4: Reserved		

0: Reference input, such as frequency, PID setting and PID feedback.

1: Counter input: Input of counter pulse.

2: Length input: Input of length pulse.

Notice: When P5.35 or P5.36 is set to be 0, P5.37~P5.46 will take effective accordingly.

Function Code	Name	Description	Setting Range	Factory Setting
P5.37	HDI1 lower limit	0.0 kHz ~50.0kHz	0.0~50.0	0.0kHz
P5.38	HDI1 lower limit corresponding setting	-100.0%~100.0%	-100.0~100.0	0.0%
P5.39	HDI1 upper limit	0.0 kHz ~50.0kHz	0.0~50.0	50.0kHz
P5.40	HDI1 upper limit corresponding setting	-100.0%~100.0%	-100.0~100.0	100.0%
P5.41	HDI1 filter time constant	0.00s~10.00s	0.00~10.00	0.10s
P5.42	HDI2 lower limit	0.0 kHz ~50.0kHz	0.0~50.0	0.0kHz
P5.43	HDI2 lower limit corresponding setting	-100.0%~100.0%	-100.0~100.0	0.0%
P5.44	HDI2 upper limit	0.0 kHz ~50.0kHz	0.0~50.0	50.0kHz
P5.45	HDI2 upper limit	-100.0%~100.0%	-100.0~100.0	100.0%

Function Code	Name	Description	Setting Range	Factory Setting
	corresponding setting			
P5.46	HDI2 filter time constant	0.00s~10.00s	0.00~10.00	0.10s

The description of P5.37~P5.46 is similar to A11.

6.7 P6 Group – Output Terminals

Function Code	Name	Description	Setting Range	Factory Setting
P6.00	HDO selection	0: High-speed pulse output 1: ON-OFF output	0~1	0

0: High-speed pulse output: The maximum pulse frequency is 50.0 kHz. Please refer to description of P6.09.

1: ON-OFF output: Please refer to description of P6.03.

Notice: The output of HDO terminal is multi-function ON-OFF output.

Function Code	Name	Description	Setting Range	Factory Setting
P6.01	Y1 output selection	Open-collector output	0~31	1
P6.02	Y2 output selection	Open-collector output	0~31	0
P6.03	HDO ON-OFF output selection	Open-collector output	0~31	0
P6.04	Relay 1 output selection	Relay output	0~31	3
P6.05	Relay 2 output selection	Relay output	0~31	0
P6.06	Relay 3 output selection	Relay output	0~31	0

OC/Relay output functions are indicated in the following table:

Setting Value	Function	Description
0	No output	Output terminal has no function.
1	Run forward	ON: During forward run.
2	Run reverse	ON: During reverse run.
3	Fault output	ON: Inverter is in fault status.
4	Motor overload	Please refer to description of PB.04~PB.06.
5	Inverter overload	Please refer to description of PB.04~PB.06.
6	FDT reached	Please refer to description of P8.25, P8.26.
7	Frequency reached	Please refer to description of P8.27.
8	Zero speed running	ON: The running frequency of inverter is zero.
9	Preset count value reached	Please refer to description of P8.22.
10	Specified count value reached	Please refer to description of P8.23.
11	Length reached	ON: Actual length (P8.20) reach the value of P8.19.
12	PLC cycle completed	After simple PLC completes one cycle, inverter will output ON signal for 200ms.
13	Running time reached	ON: The accumulated running time of inverter reaches the value of P8.24.
14	Upper frequency limit reached	ON: Running frequency reaches the value of P0.08.
15	Lower frequency limit reached	ON: Running frequency reaches the value of P0.09.
16	Ready	ON: Inverter is ready (no fault, power is ON).
17	Auxiliary motor 1 started	In the case of simple water supply system with one inverter driving three pumps, it is used to control auxiliary pumps. For details, please refer to descriptions of P8.29, P8.30 and P8.31.
18	Auxiliary motor 2 started	
19	Motor running	ON: Inverter has output signal
20	Stop pulse output	Output pulse signal for 2s when running frequency is lower than 0.1Hz
21~31	Reserved	Reserved

Function Code	Name	Description	Setting Range	Factory Setting
P6.07	AO1 function selection	Multifunctional analog output	0~14	0
P6.08	AO2 function selection	Multifunctional analog output	0~14	0
P6.09	HDO function selection	Multifunctional high-speed pulse output	0~14	0

AO/HDO output functions are indicated in the following table:

Setting Value	Function	Range
0	Running frequency	0~maximum frequency (P0.07)
1	Reference frequency	0~ maximum frequency (P0.07)
2	Motor speed	0~2* rated synchronous speed of motor
3	Output current	0~2* inverter rated current
4	Output voltage	0~2* inverter rated voltage
5	Output power	0~2* rated power
6	Output torque	0~2*rated torque
7	AI1 voltage	0~10V
8	AI2 voltage/current	0~10V/0~20mA
9	AI3 voltage	-10V~10V
10	AI4 voltage	0~10V
11	HDI1 frequency	0.1~50.0kHz
12	HDI2 frequency	0.1~50.0kHz
13	Length value	0~preset length (P8.19)
14	Count value	0~preset count value (P8.22)

Function Code	Name	Description	Setting Range	Factory Setting
P6.10	AO1 lower limit	0.0%~100.0%	0.0~100.0	0.0%
P6.11	AO1 lower limit corresponding	0.00V ~10.00V	0.00~10.00	0.00V

Function Code	Name	Description	Setting Range	Factory Setting
	output			
P6.12	AO1 upper limit	0.0%~100.0%	0.0~100.0	100.0%
P6.13	AO1 upper limit corresponding output	0.00V ~10.00V	0.00~10.00	10.00V
P6.14	AO2 lower limit	0.0%~100.0%	0.0~100.0	0.0%
P6.15	AO2 lower limit corresponding output	0.00V ~10.00V	0.00~10.00	0.00V
P6.16	AO2 upper limit	0.0%~100.0%	0.0~100.0	100.0%
P6.17	AO2 upper limit corresponding output	0.00V ~10.00V	0.00~10.00	10.00V

These parameters determine the relationship between analog output voltage/current and the corresponding output value. When the analog output value exceeds the range between lower limit and upper limit, it will output the upper limit or lower limit.

When AO is current output, 1mA is corresponding to 0.5V.

For different applications, the corresponding value of 100.0% analog output is different.

For details, please refer to description of each application.

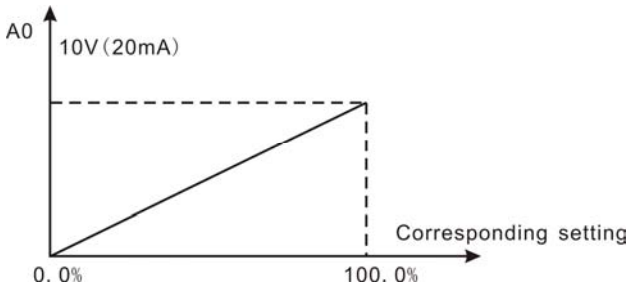

Figure 6.18 Relationship between AO and corresponding setting.

Function Code	Name	Description	Setting Range	Factory Setting
P6.18	HDO lower limit	0.0%~100.0%	0.0~100.0	0.0%
P6.19	HDO lower limit corresponding output	0.0 ~ 50.0kHz	0.0~50.0	0.0kHz
P6.20	HDO upper limit	0.0%~100.0%	0.0~100.0	100.0%
P6.21	HDO upper limit corresponding output	0.0 ~ 50.0kHz	0.0~50.0	50.0kHz

The description of P6.18~P6.21 is similar to AO.

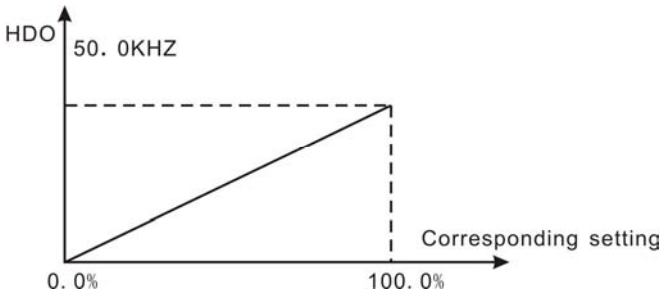

Figure 6.19 Relationship between HDO and corresponding setting.

6.8 P7 Group --Display Interface

Function Code	Name	Description	Setting Range	Factory Setting
P7.00	User password	0~65535	0~65535	0

The password protection function will be valid when set to be any nonzero data. When P7.00 is set to be 00000, user's password set before will be cleared and the password protection function will be disabled.

After the password has been set and becomes valid, the user can not access menu if the

user's password is not correct. Only when a correct user's password is input, the user can see and modify the parameters. Please keep user's password in mind.

Function Code	Name	Description	Setting Range	Factory Setting
P7.01	LCD language selection	0: Chinese 1: English	0~1	0
P7.02	Parameter copy	0: Invalid 1: Upload parameters to LCD 2: Download parameters from LCD	0~2	0

P7.02 will take effect when LCD keypad is used.

1: All value of parameters will be uploaded from inverter to LCD.

2: All value of parameters will be downloaded from LCD to inverter.

Notice: When upload or download operation completes, P7.02 will be set to 0 automatically.

Function Code	Name	Description	Setting Range	Factory Setting
P7.03	QUICK/JOG function selection	0: Quick debugging mode 1: FWD/REV switching 2: Jog 3: Clear UP/DOWN setting	0~3	0

QUICK/JOG is a multifunctional key, whose function be defined by the value of P7.03.

0: Quick debugging mode: Please refer to description of Chapter 5.

1: FWD/REV switching: Press **QUICK/JOG**, the running direction of inverter will reverse.

It is only valid if P0.01 is set to be 0.

2: Jog: Press **QUICK/JOG**, the inverter will jog.

3: Clear UP/DOWN setting: Press **QUICK/JOG**, the UP/DOWN setting will be cleared.

Function Code	Name	Description	Setting Range	Factory Setting
P7.04	STOP/RST function selection	0: Valid when keypad control (P0.01=0) 1: Valid when keypad or terminal control (P0.01=0 or 1) 2: Valid when keypad or communication control (P0.01=0)	0~3	0

Function Code	Name	Description	Setting Range	Factory Setting
		or 2) 3: Always valid		

Notice:

I The value of P7.04 only determines the STOP function of STOP/RST.

I The RESET function of **STOP/RST is always valid.**

Function Code	Name	Description	Setting Range	Factory Setting
P7.05	Keypad display selection	0: Preferential to external keypad 1: Both display, only external key valid. 2: Both display, only local key valid. 3: Both display and key valid.	0~3	0

0: When external keypad exists, local keypad will be invalid.

1: Local and external keypad display simultaneously, only external keypad is valid.

2: Local and external keypad display simultaneously, only local keypad is valid.

3: Local and external keypad display simultaneously, both keys of local and external keypad are valid. **This function should be used cautiously, otherwise it may cause malfunction.**

Notice:

I When P7.05 is set to be 1, local keypad is valid if external keypad is not connected.

I When LCD keypad is connected, P7.05 must be set to be 0.

Function Code	Name	Description	Setting Range	Factory Setting
P7.06	Running status display selection	0~0xFFFF	0~0xFFFF	0x00FF

P7.06 defines the parameters that can be displayed by LED in running status. If Bit is 0, the parameter will not be displayed; If Bit is 1, the parameter will be displayed. Press **»** /**SHIFT** to scroll through these parameters in right order . Press **DATA/ENT** + **QUICK/JOG** to scroll through these parameters in left order.

The display content corresponding to each bit of P7.06 is described in the following

table:

BIT7	BIT6	BIT5	BIT4	BIT3	BIT2	BIT1	BIT0
A11	Output terminal status	Input terminal status	PID feedback	PID preset	Output torque	Output power	Rotation speed
BIT15	BIT14	BIT13	BIT12	BIT11	BIT10	BIT9	BIT8
Count value	Length value	Step No. of PLC or multi-step	HDI2 frequency	HDI1 frequency	A14	A13	A12

For example, if user wants to display rotation speed, output power, output torque, PID preset and A11, the value of each bit is as the following table:

BIT7	BIT6	BIT5	BIT4	BIT3	BIT2	BIT1	BIT0
1	0	0	0	1	1	1	1
BIT15	BIT14	BIT13	BIT12	BIT11	BIT10	BIT9	BIT8
0	0	0	0	0	0	0	0

The value of P7.06 is 008Fh.

Notice: I/O terminal status is displayed in decimal. For details, please refer to description of P7.19 and P7.20.

Function Code	Name	Description	Setting Range	Factory Setting
P7.07	Stop status display selection	1~0xFFFF	1~0xFFFF	0x00FF

P7.07 determines the display parameters in stop status. The setting method is similar with P7.06.

The display content corresponding to each bit of P7.07 is described in the following table:

BIT7	BIT6	BIT5	BIT4	BIT3	BIT2	BIT1	BIT0
A12	A11	PID feedback	PID preset	Output terminal status	Input terminal status	DC bus voltage	Reference frequency
BIT15	BIT14	BIT13	BIT12	BIT11	BIT10	BIT9	BIT8
Reserved	Reserved	Length value	Step No. of PLC or multi-step	HDI2 frequency	HDI1 frequency	A14	A13

Function Code	Name	Description	Setting Range	Factory Setting
P7.08	Rectifier module temperature	0~100.0°C		
P7.09	IGBT module temperature	0~100.0°C		
P7.10	MCU software version			
P7.11	DSP software version			
P7.12	Accumulated running time	0~65535h		

Rectifier module temperature: Indicates the temperature of rectifier module. Overheat protection point of different inverter may be different.

IGBT module temperature: Indicates the temperature of IGBT module. Overheat protection point of different inverter may be different.

MCU Software version: Indicates current software version of MCU.

DSP Software version: Indicates current software version of DSP

Accumulated running time: Displays accumulated running time of inverter.

Notice: Above parameters are read only.

Function Code	Name	Description	Setting Range	Factory Setting
P7.13	Third latest fault type	0~30	0~30	
P7.14	Second latest fault type	0~30	0~30	
P7.15	Latest fault type	0~30	0~30	

These parameters record three recent fault types. For details, please refer to description of chapter 7.

Function Code	Name	Description	Setting Range	Factory Setting
P7.16	Output frequency at current	Output frequency at current fault.		

Function Code	Name	Description	Setting Range	Factory Setting										
	fault													
P7.17	Output current at current fault	Output current at current fault.												
P7.18	DC bus voltage at current fault	DC bus voltage at current fault.												
P7.19	Input terminal status at current fault	<p>This value records ON-OFF input terminal status at current fault. The meaning of each bit is as below:</p> <table border="1" style="margin-left: 20px;"> <tr> <td>9</td><td>8</td><td>7</td><td>6</td><td>5</td><td>4</td><td>3</td><td>2</td><td>1</td><td>0</td> </tr> </table> <p>S8 S7 S6 HDI2 HDI1 S5 S4 S3 S2 S1 1 indicates corresponding input terminal is ON, while 0 indicates OFF. Notice: This value is displayed as decimal.</p>	9	8	7	6	5	4	3	2	1	0		
9	8	7	6	5	4	3	2	1	0					
P7.20	Output terminal status at current fault	<p>This value records output terminal status at current fault. The meaning of each bit is as below:</p> <table border="1" style="margin-left: 20px;"> <tr> <td>BIT5</td><td>BIT4</td><td>BIT3</td><td>BIT2</td><td>BIT1</td><td>BIT0</td> </tr> </table> <p>RO3 RO2 RO1 HDO Y2 Y1 1 indicates corresponding output terminal is ON, while 0 indicates OFF. Notice: This value is displayed as decimal.</p>	BIT5	BIT4	BIT3	BIT2	BIT1	BIT0						
BIT5	BIT4	BIT3	BIT2	BIT1	BIT0									

6.9 P8 Group --Enhanced Function

Function Code	Name	Description	Setting Range	Factory Setting
P8.00	Acceleration time 1	0.0~3600.0s	0.0~3600.0	20.0s
P8.01	Deceleration time 1	0.0~3600.0s	0.0~3600.0	20.0s

Function Code	Name	Description	Setting Range	Factory Setting
P8.02	Acceleration time 2	0.0~3600.0s	0.0~3600.0	20.0s
P8.03	Deceleration time 2	0.0~3600.0s	0.0~3600.0	20.0s
P8.04	Acceleration time 3	0.0~3600.0s	0.0~3600.0	20.0s
P8.05	Deceleration time 3	0.0~3600.0s	0.0~3600.0	20.0s

For details, please refer to description of P0.11 and P0.12.

Function Code	Name	Description	Setting Range	Factory Setting
P8.06	Jog reference	0.00~P0.07	0.00~P0.07	5.00Hz
P8.07	Jog acceleration time	0.0~3600.0s	0.0~3600.0	20.0s
P8.08	Jog deceleration time	0.0~3600.0s	0.0~3600.0	20.0s

The meaning and factory setting of P8.07 and P8.08 is the same as P0.11 and P0.12. No matter what the value of P1.00 and P1.08 are, jog will start as start directly mode and stop as deceleration to stop mode.

Function Code	Name	Description	Setting Range	Factory Setting
P8.09	Skip frequency 1	0.00~P0.07	0.00~P0.07	0.00Hz
P8.10	Skip frequency 2	0.00~P0.07	0.00~P0.07	0.00Hz
P8.11	Skip frequency bandwidth	0.00~P0.07	0.00~P0.07	0.00Hz

By means of setting skip frequency, the inverter can keep away from the mechanical resonance with the load. P8.09 and P8.10 are centre value of frequency to be skipped.

Notice:

- I If P8.11 is 0, the skip function is invalid.
- I If both P8.09 and P8.10 are 0, the skip function is invalid no matter what P8.11 is.
- I Operation is prohibited within the skip frequency bandwidth, but changes during acceleration and deceleration are smooth without skip.
- I The relation between output frequency and reference frequency is shown in following figure.

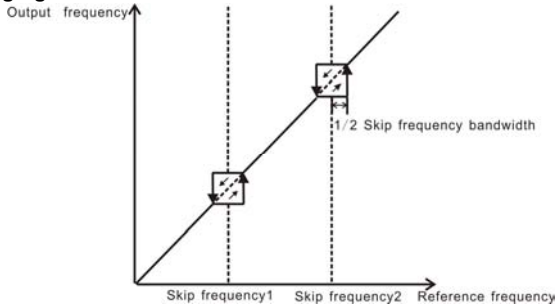

Figure 6.20 Skip frequency diagram.

Function Code	Name	Description	Setting Range	Factory Setting
P8.12	Traverse amplitude	0.0~100.0%	0.0~100.0	0.0%
P8.13	Jitter frequency	0.0~50.0%	0.0~50.0	0.0%
P8.14	Rise time of traverse	0.1~3600.0s	0.1~3600.0	5.0s
P8.15	Fall time of traverse	0.1~3600.0s	0.1~3600.0	5.0s

Traverse operation is widely used in textile and chemical fiber industry. The typical application is shown in following figure.

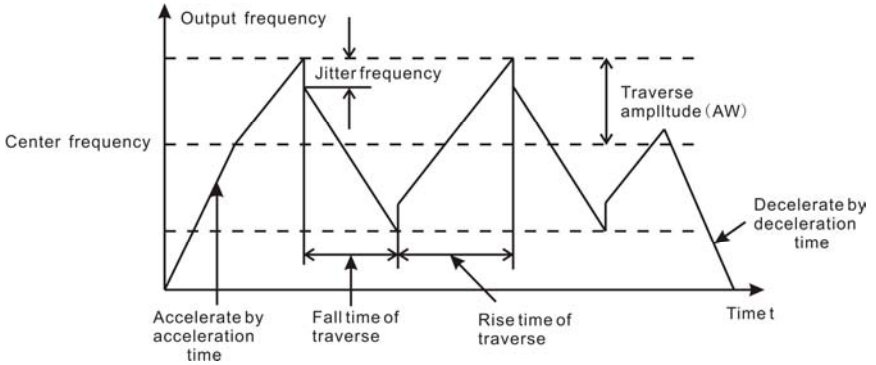

Figure 6.21 Traverse operation diagram.

Center frequency (CF) is reference frequency.

Traverse amplitude (AW) = center frequency (CF) * P8.12%

Jitter frequency = traverse amplitude (AW) * P8.13%

Rise time of traverse: Indicates the time rising from the lowest traverse frequency to the highest traverse frequency.

Fall time of traverse: Indicates the time falling from the highest traverse frequency to the lowest traverse frequency.

Notice:P8.12 determines the output frequency range which is as below:

(1-P8.12%) * reference frequency ≤ output frequency ≤ (1+P8.12%) * reference frequency

The output frequency of traverse is limited by upper frequency limit (P0.08) and lower frequency limit (P0.09).

Function Code	Name	Description	Setting Range	Factory Setting
P8.16	Auto reset times	0~3	0~3	0
P8.17	Fault relay action	0: Disabled 1: Enabled	0~1	0
P8.18	Reset interval	0.1~100.0s	0.1~100.0	1.0s

Auto reset function can reset the fault in preset times and interval. When P8.16 is set to be 0, it means “auto reset” is disabled and the protective device will be activated in case of fault.

P8.17 defines if fault relay active or not during auto reset. If continuous production without interruption is needed, please set P8.17=0.

Notice:

- I The fault such as OUT 1, OUT 2, OUT 3, OH1 and OH2 cannot be reset automatically.**
- I If fault has not occurred for ten minutes after the fault is reset, inverter will automatically clear the previous times of auto reset.**

Function Code	Name	Description	Setting Range	Factory Setting
P8.19	Preset length	1~65535	1~65535	1000
P8.20	Actual length	0~65535	0~65535	0
P8.21	Number of pulse per cycle	0.1~6553.5	0.1~6553.5	100.0

These parameters are mainly used for fixed-length control.

The length is calculated by input pulse signal. If input pulse frequency is high, it is required to use HDI1 or HDI2 input (P5.35 or P5.36 = 2)

Actual length (P8.20) = Accumulated input pulse number / Number of pulse per cycle (P8.21).

When the value of P8.20 exceeds the value of P8.19, if multifunctional output terminal is set to be 11 (Length reached), ON signal will be output.

Function Code	Name	Description	Setting Range	Factory Setting
P8.22	Preset count value	1~65535	1~65535	1000
P8.23	Specified count value	1~65535	1~65535	1000

The count pulse input channel can be S1~S5 (≤200Hz) and HDI.

If function of output terminal is set as preset count reached, when the count value reaches preset count value (P8.22), it will output an ON-OFF signal. Inverter will clear the counter and restart counting.

If function of output terminal is set as specified count reached, when the count value reaches specified count value (P8.23), it will output an ON-OFF signal until the count value reaches preset count value (P8.22). Inverter will clear the counter and restart counting.

Notice:

- I Specified count value (P8.23) should not be greater than preset count value**

(P8.22).

I Output terminal can be RO1, RO2 or HDO.

This function is shown as following figure.

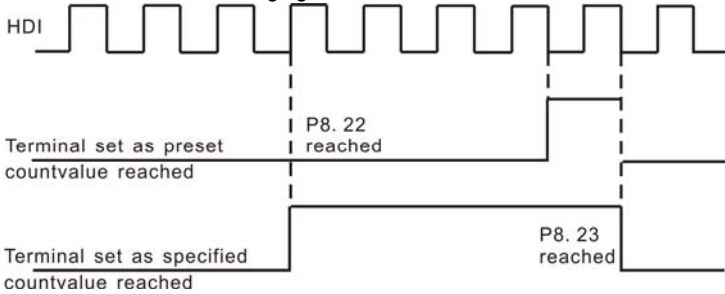

Figure 6.22 Timing chart for preset and specified count reached.

Function Code	Name	Description	Setting Range	Factory Setting
P8.24	Preset running time	0~65535h	0~65535	65535 h

If function of output terminal is set as running time reached, when the accumulated running time reaches the preset running time, it will output an ON-OFF signal.

Function Code	Name	Description	Setting Range	Factory Setting
P8.25	FDT level	0.00~ P0.07	0.00~ P0.07	50.00Hz
P8.26	FDT lag	0.0~100.0%	0.0~100.0	5.0%

When the output frequency reaches a certain preset frequency (FDT level), output terminal will output an ON-OFF signal until output frequency drops below a certain frequency of FDT level (FDT level - FDT lag), as shown in following figure.

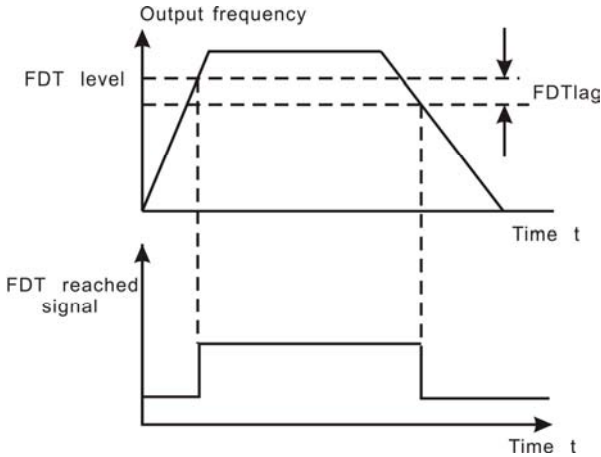

Figure 6.23 FDT Level diagram.

Function Code	Name	Description	Setting Range	Factory Setting
P8.27	Frequency arrive detecting range	0.0~100.0% (maximum frequency)	0.0~100.0	0.0%

When output frequency is within the detecting range of reference frequency, an ON-OFF signal will be output.

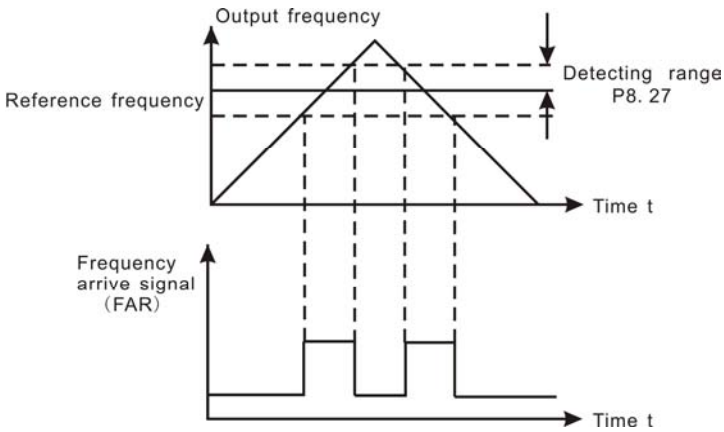

Figure 6.24 Frequency arriving detection diagram.

Function Code	Name	Description	Setting Range	Factory Setting
P8.28	Droop control	0.00~10.00Hz	0.00~10.00	0.00Hz

When several motors drive the same load, each motor's load is different because of the difference of motor's rated speed. The load of different motors can be balanced through droop control function which makes the speed droop along with load increasing. When the motor outputs rated torque, actual frequency drop is equal to P8.28. User can adjust this parameter from small to big gradually during commissioning. The relation between load and output frequency is in the following figure.

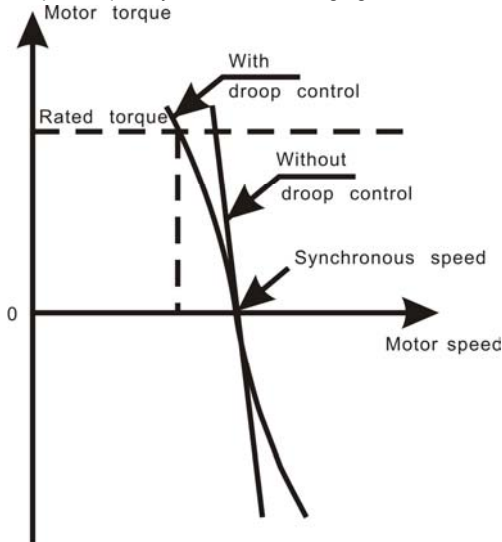

Figure 6.25 Droop control diagram.

Function Code	Name	Description	Setting Range	Factory Setting
P8.29	Auxiliary motor selection	0: Invalid 1: Motor 1 valid 2: Motor 2 valid 3: Both valid	0~3	0
P8.30	Auxiliary motor1 START/STOP delay time	0.0~3600.0s	0.0~3600.0	5.0s
P8.31	Auxiliary	0.0~3600.0s	0.0~3600.0	5.0s

Function Code	Name	Description	Setting Range	Factory Setting
	motor2 START/STOP delay time			

Above parameters are used to realize simple water supply control function which one inverter drives three pumps (one variable-frequency pump and two power-frequency pumps). The control logic is shown in the following figure.

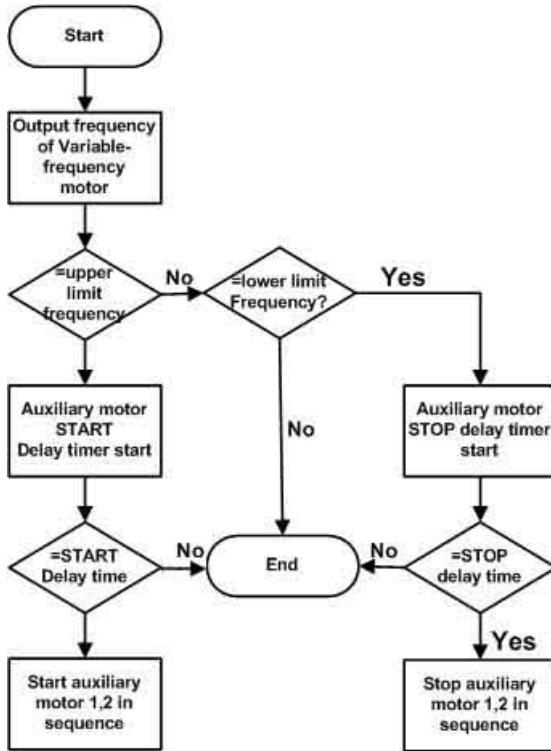

Figure 6.26 Simple water-supply function logical diagram.

Notice:

- I Delay time of start auxiliary motor and stop auxiliary motor are the same.
- I PID control (P0.03=6) is necessary for simple water supply control.
- I P1.14 should not be set to be 1.

Function Code	Name	Description	Setting Range	Factory Setting
P8.32	Brake threshold voltage	320.0~750.0V	320.0~750.0	700.0V

When the DC bus voltage is greater than the value of P8.32, the inverter will start dynamic braking.

Notice:

- I **Factory setting is 380V if rated voltage of inverter is 220V.**
- I **Factory setting is 700V if rated voltage of inverter is 380V.**
- I **The value of P8.32 is corresponding to the DC bus voltage at rated input voltage.**

Function Code	Name	Description	Setting Range	Factory Setting
P8.33	Low-frequency threshold of restraining oscillation	0~9999	0~9999	1000
P8.34	High-frequency threshold of restraining oscillation	0~9999	0~9999	1000

The smaller the value of P8.33 and P8.34, the stronger the restraining effect.

Notice: Most motor may have current oscillation at some frequency point. Please be cautious to adjust these parameters to weaken oscillation.

6.10 P9 Group --PID Control

PID control is a common used method in process control, such as flow, pressure and temperature control. The principle is firstly detect the bias between preset value and feedback value, then calculate output frequency of inverter according to proportional gain, integral and differential time. Please refer to following figure.

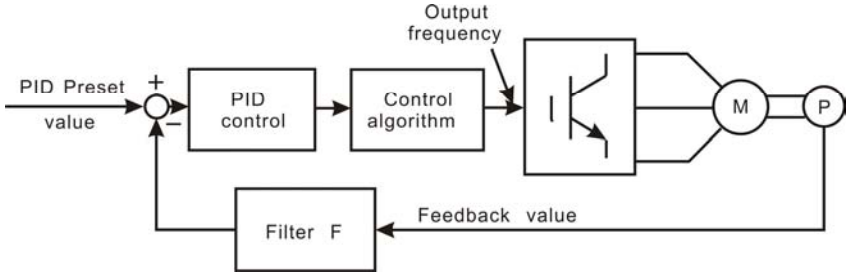

Figure 6.27 PID control diagram.

Notice: To make PID take effect, P0.03 must be set to be 6.

Function Code	Name	Description	Setting Range	Factory Setting
P9.00	PID preset source selection	0: Keypad 1: AI1 2: AI2 3: AI3 4: AI4 5: HDI1 6: HDI2 7: Communication 8: Simple PLC	0~8	0
P9.01	Keypad PID preset	0.0%~100.0%	0.0~100.0	0.0%
P9.02	PID feedback source selection	0: AI1 1: AI2 2: AI3 3: AI4 4: AI1-AI2 5: AI3-AI4 6: HDI1 7: HDI2 8: HDI1-HDI2 9: Communication	0~9	0

These parameters are used to select PID preset and feedback source.

Notice:

- I Preset value and feedback value of PID are percentage value.
- I 100% of preset value is corresponding to 100% of feedback value.
- I Preset source and feedback source must not be same, otherwise PID will be malfunction.

Function Code	Name	Description	Setting Range	Factory Setting
P9.03	PID output characteristics	0: Positive 1: Negative	0~1	0

0: Positive. When the feedback value is greater than the preset value, output frequency will be decreased, such as tension control in winding application.

1: Negative. When the feedback value is greater than the preset value, output frequency will be increased, such as tension control in unwinding application.

Function Code	Name	Description	Setting Range	Factory Setting
P9.04	Proportional gain (Kp)	0.00~100.00	0.00~100.00	0.10
P9.05	Integral time (Ti)	0.01~10.00s	0.01~10.00	0.10s
P9.06	Differential time (Td)	0.00~10.00s	0.00~10.00	0.00s

Optimize the responsiveness by adjusting these parameters while driving an actual load.

Adjusting PID control:

Use the following procedure to activate PID control and then adjust it while monitoring the response.

- ⌚ Enabled PID control (P0.03=6)
- ⌚ Increase the proportional gain (Kp) as far as possible without creating oscillation.
- ⌚ Reduce the integral time (Ti) as far as possible without creating oscillation.
- ⌚ Increase the differential time (Td) as far as possible without creating oscillation.

Making fine adjustments:

First set the individual PID control constants, and then make fine adjustments.

- I Reducing overshooting

If overshooting occurs, shorten the differential time and lengthen the integral time.

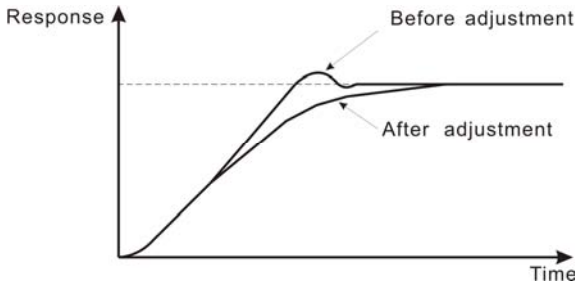

Figure 6.28 Reducing overshooting diagram.

I Rapidly stabilizing control status

To rapidly stabilize the control conditions even when overshooting occurs, shorten the integral time and lengthen the differential time.

I Reducing long-cycle oscillation

If oscillation occurs with a longer cycle than the integral time setting, it means that integral operation is strong. The oscillation will be reduced as the integral time is lengthened.

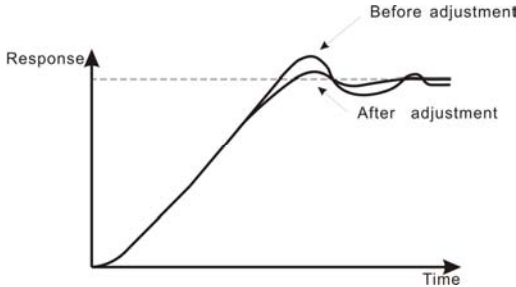

Figure 6.29 Reducing long-cycle oscillation diagram.

I Reducing short-cycle oscillation

If the oscillation cycle is short and oscillation occurs with a cycle approximately the same as the differential time setting, it means that the differential operation is strong. The oscillation will be reduced as the differential time is shortened.

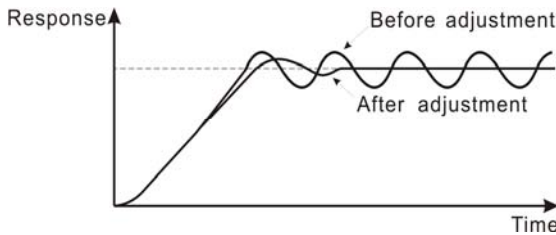

Figure 6.30 Reducing short-cycle oscillation diagram.

If oscillation cannot be reduced even by setting the differential time to 0, then either lower the proportional gain or raise the PID primary delay time constant.

Function Code	Name	Description	Setting Range	Factory Setting
P9.07	Sampling cycle (T)	0.01~100.00s	0.01~100.00	0.50s
P9.08	Bias limit	0.0~100.0%	0.0~100.0	0.0%

Sampling cycle T refers to the sampling cycle of feedback value. The PI regulator calculates once in each sampling cycle. The bigger the sampling cycle, the slower the response is.

Bias limit defines the maximum bias between the feedback and the preset. PID stops operation when the bias is within this range. Setting this parameter correctly is helpful to improve the system output accuracy and stability.

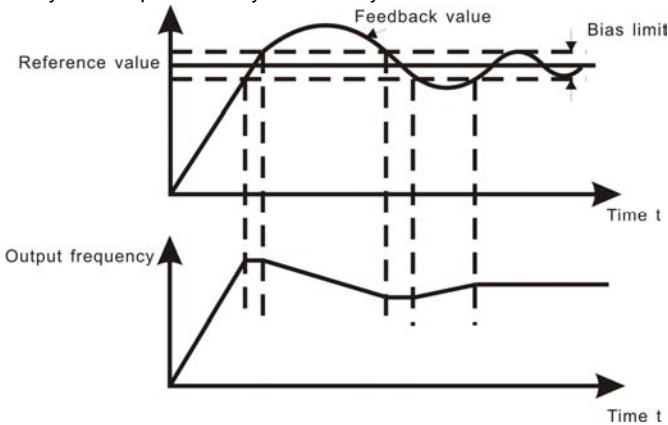

Figure 6.31 Relationship between bias limit and output frequency.

Function Code	Name	Description	Setting Range	Factory Setting
P9.09	PID output filter time	0.00~10.00s	0.00~10.00	0.00

The bigger the filter time, the better the immunity capability, but the response becomes slow, vice versa.

Function Code	Name	Description	Setting Range	Factory Setting
P9.10	Feedback lost detecting	0.0~100.0%	0.0~100.0	0.0%

Function Code	Name	Description	Setting Range	Factory Setting
	value			
P9.11	Feedback lost detecting time	0.0~3600.0s	0.0~3600.0	1.0s

When feedback value is less than P9.10 continuously for the period determined by P9.11, the inverter will alarm feedback lost failure (PIDE).

Notice: 100% of P9.10 is the same as 100% of P9.01.

6.11 PA Group --Simple PLC and Multi-step Speed Control

Simple PLC function can enable the inverter change its output frequency and directions automatically according to preset running time. For multi-step speed function, the output frequency can be changed only by multi-step terminals.

Notice:

I Simple PLC has 16 steps which can be selected.

I If P0.03 is set to be 5, 16 steps are available for multi-step speed. Otherwise only 15 steps are available (step 1~15).

Function Code	Name	Description	Setting Range	Factory Setting
PA.00	Simple PLC mode	0: Stop after one cycle 1: Hold last frequency after one cycle 2: Circular run	0~2	0

0: Stop after one cycle: Inverter stops automatically as soon as it completes one cycle, and it is needed to give run command to start again.

1: Hold last frequency after one cycle: Inverter holds frequency and direction of last step after one cycle.

2: Circular run: Inverter continues to run cycle by cycle until receive a stop command.

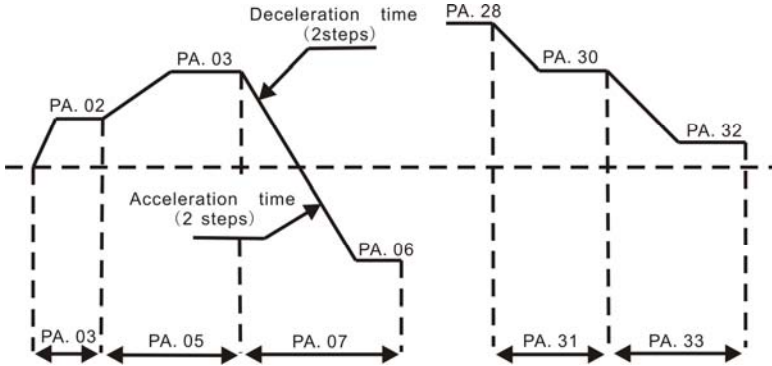

Figure 6.32 Simple PLC operation diagram.

Function Code	Name	Description	Setting Range	Factory Setting
PA.01	Simple PLC status saving selection	0: Not saved 1: Saved 2: Not saved when power off, saved when stop	0~1	0

This parameter determines whether the running step and output frequency of simple PLC should be saved. If PA.01 is set to be 2, running step and output frequency will be saved when inverter stops, but will not be saved when inverter is power off.

Function Code	Name	Description	Setting Range	Factory Setting
PA.02	Multi-step speed 0	-100.0~100.0%	-100.0~100.0	0.0%
PA.03	0 th Step running time	0.0~6553.5s(h)	0.0~6553.5	0.0s
PA.04	Multi-step speed 1	-100.0~100.0%	-100.0~100.0	0.0%
PA.05	1 st Step running time	0.0~6553.5s(h)	0.0~6553.5	0.0s
PA.06	Multi-step speed 2	-100.0~100.0%	-100.0~100.0	0.0%
PA.07	2 nd Step running time	0.0~6553.5s(h)	0.0~6553.5	0.0s
PA.08	Multi-step	-100.0~100.0%	-100.0~100.0	0.0%

Function Code	Name	Description	Setting Range	Factory Setting
	speed 3			
PA.09	3 rd Step running time	0.0~6553.5s(h)	0.0~6553.5	0.0s
PA.10	Multi-step speed 4	-100.0~100.0%	-100.0~100.0	0.0%
PA.11	4 th Step running time	0.0~6553.5s(h)	0.0~6553.5	0.0s
PA.12	Multi-step speed 5	-100.0~100.0%	-100.0~100.0	0.0%
PA.13	5 th Step running time	0.0~6553.5s(h)	0.0~6553.5	0.0s
PA.14	Multi-step speed 6	-100.0~100.0%	-100.0~100.0	0.0%
PA.15	6 th Step running time	0.0~6553.5s(h)	0.0~6553.5	0.0s
PA.16	Multi-step speed 7	-100.0~100.0%	-100.0~100.0	0.0%
PA.17	7 th Step running time	0.0~6553.5s(h)	0.0~6553.5	0.0s
PA.18	Multi-step speed 8	-100.0~100.0%	-100.0~100.0	0.0%
PA.19	8 th Step running time	0.0~6553.5s(h)	0.0~6553.5	0.0s
PA.20	Multi-step speed 9	-100.0~100.0%	-100.0~100.0	0.0%
PA.21	9 th Step running time	0.0~6553.5s(h)	0.0~6553.5	0.0s
PA.22	Multi-step speed 10	-100.0~100.0%	-100.0~100.0	0.0%
PA.23	10 th Step running time	0.0~6553.5s(h)	0.0~6553.5	0.0s
PA.24	Multi-step speed 11	-100.0~100.0%	-100.0~100.0	0.0%

Function Code	Name	Description	Setting Range	Factory Setting
PA.25	11 th Step running time	0.0~6553.5s(h)	0.0~6553.5	0.0s
PA.26	Multi-step speed 12	-100.0~100.0%	-100.0~100.0	0.0%
PA.27	12 th Step running time	0.0~6553.5s(h)	0.0~6553.5	0.0s
PA.28	Multi-step speed 13	-100.0~100.0%	-100.0~100.0	0.0%
PA.29	13 th Step running time	0.0~6553.5s(h)	0.0~6553.5	0.0s
PA.30	Multi-step speed 14	-100.0~100.0%	-100.0~100.0	0.0%
PA.31	14 th Step running time	0.0~6553.5s(h)	0.0~6553.5	0.0s
PA.32	Multi-step speed 15	-100.0~100.0%	-100.0~100.0	0.0%
PA.33	15 th Step running time	0.0~6553.5s(h)	0.0~6553.5	0.0s

Notice:

- I **100% of multi-step speed x corresponds to the maximum frequency (P0.07).**
- I **If the value of multi-step speed x is negative, the direction of this step will be reverse, otherwise it will be forward.**
- I **The unit of x step running time is determined by PA.36.**

Selection of step is determined by combination of multi-step terminals. Please refer to following figure and table.

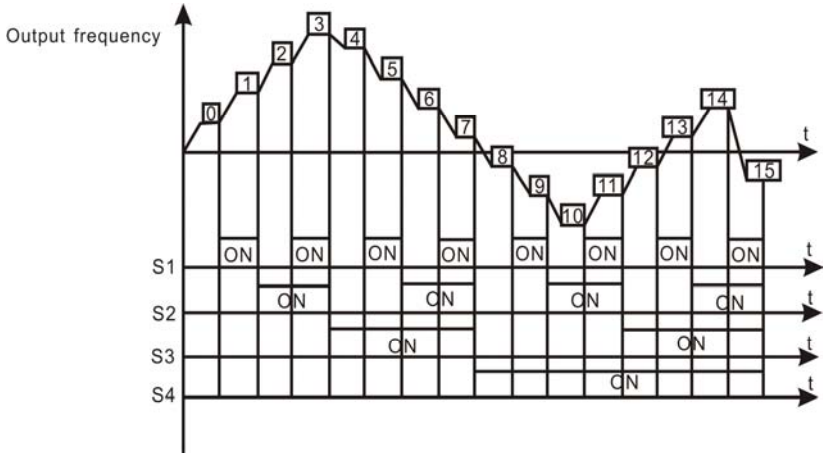

Figure 6.33 Multi-steps speed operation diagram.

Terminal Step	Multi-step speed reference1	Multi-step speed reference2	Multi-step speed reference3	Multi-step speed reference4
0	OFF	OFF	OFF	OFF
1	ON	OFF	OFF	OFF
2	OFF	ON	OFF	OFF
3	ON	ON	OFF	OFF
4	OFF	OFF	ON	OFF
5	ON	OFF	ON	OFF
6	OFF	ON	ON	OFF
7	ON	ON	ON	OFF
8	OFF	OFF	OFF	ON
9	ON	OFF	OFF	ON
10	OFF	ON	OFF	ON
11	ON	ON	OFF	ON
12	OFF	OFF	ON	ON
13	ON	OFF	ON	ON
14	OFF	ON	ON	ON
15	ON	ON	ON	ON

Function Code	Name	Description	Setting Range	Factory Setting
PA.34	ACC/DEC time selection for step 0~7	0~65535	0~65535	0
PA.35	ACC/DEC time selection for step 8~15	0~65535	0~65535	0

These parameters are used to determine the ACC/DEC time from one step to next step.

There are four ACC/DEC time groups.

Function Code	Binary Digit		Step No.	ACC/DEC Time 0	ACC/DEC Time 1	ACC/DEC Time 2	ACC/DEC Time 3
	PA.34	BIT1	BIT0	0	00	01	10
BIT3		BIT2	1	00	01	10	11
BIT5		BIT4	2	00	01	10	11
BIT7		BIT6	3	00	01	10	11
BIT9		BIT8	4	00	01	10	11
BIT11		BIT10	5	00	01	10	11
BIT3		BIT12	6	00	01	10	11
BIT15		BIT14	7	00	01	10	11
PA.35	BIT1	BIT0	8	00	01	10	11
	BIT3	BIT2	9	00	01	10	11
	BIT5	BIT4	10	00	01	10	11
	BIT7	BIT6	11	00	01	10	11
	BIT9	BIT8	12	00	01	10	11
	BIT11	BIT10	13	00	01	10	11
	BIT3	BIT12	14	00	01	10	11
	BIT15	BIT14	15	00	01	10	11

For example: To set the acceleration time of following table:

Step No.	0	1	2	3	4	5	6	7	8	9	10	11	12	13	14	15
ACC/DEC time group	0	1	2	3	2	1	3	0	3	3	2	0	0	0	2	2

The value of every bit of PA.34 and PA.35 is:

Low byte	BIT 0	BIT 1	BIT 2	BIT 3	BIT 4	BIT 5	BIT 6	BIT 7
PA.34	0	0	1	0	0	1	1	1
PA.35	1	1	1	1	0	1	0	0
High byte	BIT 8	BIT 9	BIT 10	BIT 11	BIT 12	BIT 13	BIT 14	BIT 15
PA.34	0	1	1	0	1	1	0	0
PA.35	0	0	0	0	0	1	0	1

So the value of PA.34 should be: 0X36E4, the value of PA.35 should be: 0XA02F.

Function Code	Name	Description	Setting Range	Factory Setting
PA.36	Time unit	0: Second 1: Hour	0~1	0

This parameter determines the unit of x step running time.

6.12 PB Group -- Protection Parameters

Function Code	Name	Description	Setting Range	Factory Setting
PB.00	Input phase-failure protection	0: Disabled 1: Enabled	0~1	1
PB.01	Output phase-failure protection	0: Disabled 1: Enabled	0~1	1

Notice: Please be cautious to set these parameters as disabled. Otherwise it may cause inverter and motor overheat even damaged.

Function Code	Name	Description	Setting Range	Factory Setting
PB.02	Motor overload protection	0: Disabled 1: Normal motor 2: Variable frequency motor	0~2	2

1: For normal motor, the lower the speed, the poorer the cooling effect. Based on this reason, if output frequency is lower than 30Hz, inverter will reduce the motor overload protection threshold to prevent normal motor from overheat.

2: As the cooling effect of variable frequency motor has nothing to do with running speed, it is not required to adjust the motor overload protection threshold.

Function Code	Name	Description	Setting Range	Factory Setting
PB.03	Motor overload protection current	20.0%~120.0%	20.0~120.0	100.0%

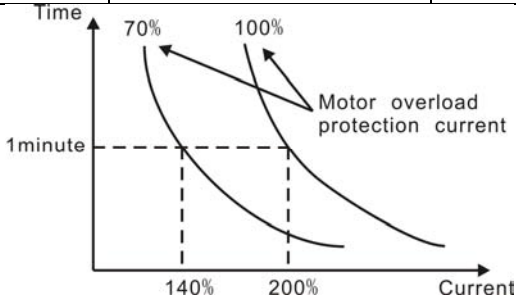

Figure 6.34 Motor overload protection curve.

The value can be determined by the following formula:

$$\text{Motor overload protection current} = (\text{motor rated current} / \text{inverter rated current}) * 100\%$$

Notice:

- I This parameter is normally used when rated power of inverter is greater than rated power of motor.
- I Motor overload protection time: 60s with 200% of rated current. For details, please refer to above figure.

Function Code	Name	Description	Setting Range	Factory Setting
PB.04	Overload pre-warning threshold	20.0%~150.0%	20.0~150.0	130.0%
PB.05	Overload pre-warning selection	0: Always detect relative to motor rated current 1: Detect while constant speed relative to motor rated current 2: Always detect relative to inverter rated current 3: Detect while constant speed relative to inverter rated current	0~3	0

Function Code	Name	Description	Setting Range	Factory Setting
PB.06	Overload pre-warning delay time	0.0~30.0s	0.0~30.0	5.0s

The value of PB.05 determines the pre-warning category, such as motor overload (OL1) or inverter overload (OL2).

PB.04 determines the current threshold of pre-warning action, it is a percentage of the rated current. When output current of inverter exceeds the value of PB.04 and last the duration determined by PB.06, inverter will output a pre-warning signal. Please refer to following diagram:

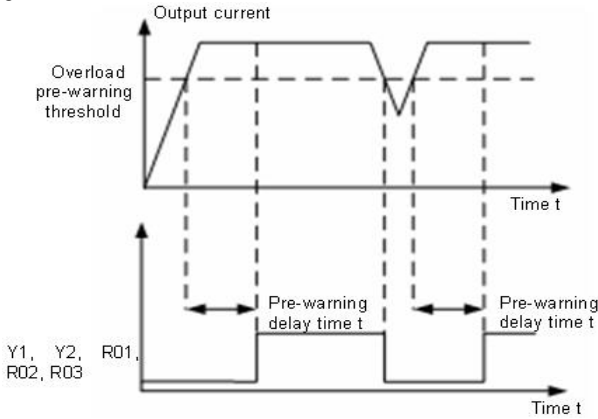

Figure 6.35 Overload pre-warning schematic diagram.

Function Code	Name	Description	Setting Range	Factory Setting
PB.07	Threshold of trip-free	230.0V~600.0V	230.0~600.0	450.0V
PB.08	Decrease rate of trip-free	0.00Hz~P0.07	0.00Hz~P0.07	0.00Hz

If PB.08 is set to be 0, the trip-free function is invalid.

Trip-free function enables the inverter to perform low-voltage compensation when DC bus voltage drops below PB.07. The inverter can continue to run without tripping by reducing its output frequency and feedback energy via motor.

Notice: If PB.08 is too big, the feedback energy of motor will be too large and may cause over-voltage fault. If PB.08 is too small, the feedback energy of motor will be

too small to achieve voltage compensation effect. So please set PB.08 according to load inertia and the actual load.

Function Code	Name	Description	Setting Range	Factory Setting
PB.09	Over-voltage stall protection	0: Disabled 1: Enabled	0~1	0
PB.10	Over-voltage stall protection point	120~150%	120~150	125%

During deceleration, the motor's decelerating rate may be lower than that of inverter's output frequency due to the load inertia. At this time, the motor will feed the energy back to the inverter, resulting in DC bus voltage rise. If no measures taken, the inverter will trip due to over voltage.

During deceleration, the inverter detects DC bus voltage and compares it with over-voltage stall protection point. If DC bus voltage exceeds PB.10, the inverter will stop reducing its output frequency. When DC bus voltage become lower than PB.10, the deceleration continues, as shown in following figure.

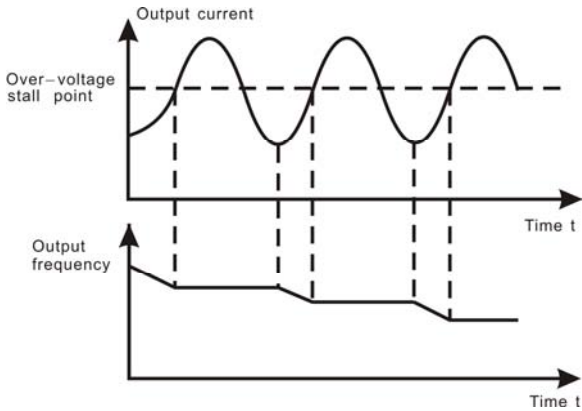

Figure 6.36 Over-voltage stall function.

Function Code	Name	Description	Setting Range	Factory Setting
PB.11	Over-current protection	0: Disabled 1: Enabled	0~1	1
PB.12	Over-current stall threshold	100~200%	100~200	160%

Function Code	Name	Description	Setting Range	Factory Setting
PB.13	Frequency decrease rate	0.00~50.00Hz/s	0.00~50.00	1.00Hz/s

During acceleration of inverter, the actual motor speed rise rate may lower than the output frequency rise rate because of too big load. If no measures to take, inverter will trip caused by over-current.

The principle of over-current protection is to detect the output current of inverter during inverter operation and compare it with over-current stall threshold determined by PB.12. If it exceeds the value of PB.12 during acceleration, inverter will remain output frequency; if it exceeds the value of PB.12 during constant speed running, inverter will decrease output frequency. When output current of inverter is lower than the value of PB.12, inverter will continue to accelerate until output frequency reach frequency reference.

Please refer to following diagram.

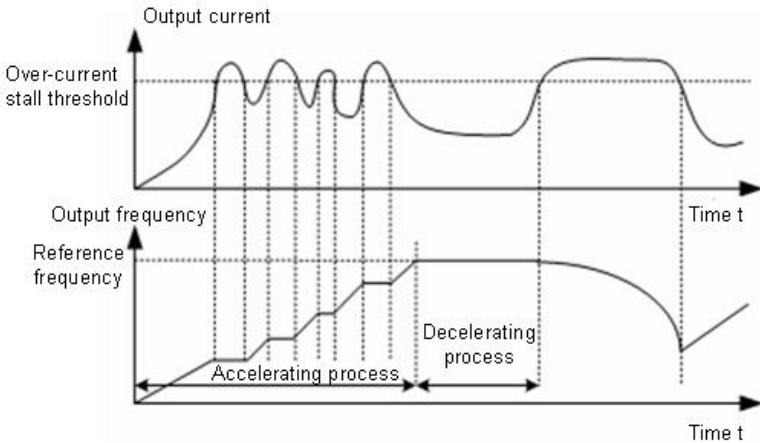

Figure 6.37 Over-current stall function.

6.13 PC Group --Serial Communication

For details, please refer to operation manual of serial communication card.

6.14 PD Group --Supplementary Function

Function Code	Name	Description	Setting Range	Factory Setting
PD.00	Upper frequency limit selection	0: Keypad 1: AI1 2: AI2 3: AI3 4: AI4 5: HDI 1 6: HDI 2 7: communication	0~7	0

0: Keypad: User can set the value of P0.08 as upper frequency limit.

1~7: Please refer to description of P0.03.

Function Code	Name	Description	Setting Range	Factory Setting
PD.01	NO/NC input selection	0~0x3FF	0~0x3FF	0

This parameter determines NO or NC status of each input terminal. It is a hexadecimal value. If the corresponding bit is set to be 1, that means this input terminal is normal-close (NC) input. Please refer to following table.

BIT9	BIT8	BIT7	BIT6	BIT5	BIT4	BIT3	BIT2	BIT1	BIT0
S8	S7	S6	HDI2	HDI1	S5	S4	S3	S2	S1

Notice: Only when HDI1 or HDI2 is set to be ON-OFF input, the setting of bit 5 or bit 6 will take effect.

6.15 PE Group –Factory Setting

This group is the factory-set parameter group. It is prohibited for user to access.

7. TROUBLE SHOOTING

7.1 Fault and trouble shooting

Fault Code	Fault Type	Reason	Solution
OUT1	IGBT Ph-U fault	1. Acc/Dec time is too short.	1. Increase Acc/Dec time. 2. Ask for support. 3. Inspect external equipment and eliminate interference.
OUT2	IGBT Ph-V fault	2. IGBT module fault.	
OUT3	IGBT Ph-W fault	3. Malfunction caused by interference. 4. Grounding is not properly.	
OC1	Over-current when acceleration	1. Short-circuit or ground fault occurred at inverter output. 2. Load is too heavy or Acc/Dec time is too short. 3. V/F curve is not suitable. 4. Sudden change of load.	1. Inspect whether motor damaged, insulation worn or cable damaged. 2. Increase Acc/Dec time or select bigger capacity inverter. 3. Check and adjust V/F curve. 4. Check the load.
OC2	Over-current when deceleration		
OC3	Over-current when constant speed running		
OV1	Over-voltage when acceleration	1. Dec time is too short and regenerative energy from the motor is too large. 2. Input voltage is too high.	1. Increase Dec time or connect braking resistor 2. Decrease input voltage within specification.
OV2	Over-voltage when deceleration		
OV3	Over-voltage when constant speed running		
UV	DC bus Under-voltage	1. Open phase occurred with power supply. 2. Momentary power loss occurred 3. Wiring terminals for input power supply are	Inspect the input power supply or wiring.

Fault Code	Fault Type	Reason	Solution
		loose. 4. Voltage fluctuations in power supply are too large.	
OL1	Motor overload	1. Motor drive heavy load at low speed for a long time. 2. Improper V/F curve 3. Improper motor's overload protection threshold (PB.03) 4. Sudden change of load.	1. Select variable frequency motor. 2. Check and adjust V/F curve. 3. Check and adjust PB.03 4. Check the load.
OL2	Inverter overload	1. Load is too heavy or Acc/Dec time is too short. 2. Improper V/F curve 3. Capacity of inverter is too small.	1. Increase Acc/Dec time or select bigger capacity inverter. 2. Check and adjust V/F curve. 3. Select bigger capacity inverter.
SPI	Input phase failure	1. Open-phase occurred in power supply. 2. Momentary power loss occurred. 3. Wiring terminals for input power supply are loose. 4. Voltage fluctuations in power supply are too large. 5. Voltage balance between phase is bad.	Check the wiring, installation and power supply.
SPO	Output phase failure	1. There is a broken wire in the output cable 2. There is a broken wire in the motor winding. 3. Output terminals are	Check the wiring and installation.

Fault Code	Fault Type	Reason	Solution
		loose.	
OH1	Rectify overheat	1. Ambient temperature is too high. 2. Near heat source.	1. Install cooling unit. 2. Remove heat source.
OH2	IGBT overheat	3. Cooling fans of inverter stop or damaged. 4. Obstruction of ventilation channel 5. Carrier frequency too high.	3. Replace cooling fan 4. Clear the ventilation channel. 5. Decrease carrier frequency.
EF	External fault	Sx: External fault input terminal take effect.	Inspect external equipment.
CE	Communication fault	1. Improper baud rate setting. 2. Receive wrong data. 3. Communication is interrupted for Long time	1. Set proper baud rate. 2. Check communication devices and signals.
ITE	Current detection fault	1. Wires or connectors of control board are loose 2. Hall sensor is damaged. 3. Amplifying circuit is abnormal.	1. Check the wiring. 2. Ask for support.
TE	Autotuning fault	1. Improper setting of motor rated parameters. 2. Overtime of autotuning.	1. Set rated parameters according to motor nameplate. 2. Check motor's wiring.
PCE	Encoder fault	1. Signal wire of encoder was broken. 2. Encoder was damaged.	1. Inspect encoder connection. 2. Inspect whether the encoder output signal or not.
PCDE	Encoder reverse fault	Encoder signal wire was connected wrong.	Adjust encoder wiring.
OPSE	System fault	1. Serious disturbance	1. Press STOP/RST to

Fault Code	Fault Type	Reason	Solution
		cause control board unable to operate properly. 2. Noise cause control board malfunction.	reset or install input filter at input side. 2. Ask for support.
EEP	EEPROM fault	Read/Write fault of control parameters	Press STOP/RESET to reset Ask for support
PIDE	PID feedback fault	1. PID feedback disconnected. 2. PID feedback source disappears.	1. Inspect PID feedback signal wire. 2. Inspect PID feedback source.
BCE	Brake unit fault	1. Braking circuit failure or brake tube damaged. 2. Too low resistance of externally connected braking resistor.	1. Inspect braking unit, replace braking tube. 2. Increase braking resistance.
-END-	Trial time reached	Trial time which determined by factory reached.	Contact supplier and ask for support.
LCD-E	LCD disconnected	1. LCD disconnected 2. Material broken during tension control	1. Press STOP/RST to reset, connect LCD then download or upload parameter. 2. Check material.
TI-E	Clock chip fault	Clock chip damaged	Ask for support.
	Factory Reserved		

7.2 Common Faults and Solutions

Inverter may have following faults or malfunctions during operation, please refer to the following solutions.

No display after power on:

- u Inspect whether the voltage of power supply is the same as the inverter rated voltage or not with multi-meter. If the power supply has problem, inspect and solve

it.

- ⊣ Inspect whether the three-phase rectify bridge is in good condition or not. If the rectification bridge is burst out, ask for support.
- ⊣ Check the CHARGE light. If the light is off, the fault is mainly in the rectify bridge or the buffer resistor. If the light is on, the fault may be lies in the switching power supply. Please ask for support.

Power supply air switch trips off when power on:

- ⊣ Inspect whether the input power supply is grounded or short circuit. Please solve the problem.
- ⊣ Inspect whether the rectify bridge has been burnt or not. If it is damaged, ask for support.

Motor doesn't move after inverter running:

- ⊣ Inspect if there is balanced three-phase output among U, V, W. If yes, then motor could be damaged, or mechanically locked. Please solve it.
- ⊣ If the output is unbalanced or lost, the inverter drive board or the output module may be damaged, ask for support..

Inverter displays normally when power on, but switch at the input side trips when running:

- ⊣ Inspect whether the output side of inverter is short circuit. If yes, ask for support.
- ⊣ Inspect whether ground fault exists. If yes, solve it.
- ⊣ If trip happens occasionally and the distance between motor and inverter is too far, it is recommended to install output AC reactor.

8. MAINTENANCE

8.1 Daily Maintenance

To prevent energy saver failure, ensure normal operation of the equipment, and prolong the service life of the energy saver, it is necessary to carry out daily maintenance for the energy saver. Daily maintenance covers:

Check Item	Content
Temperature/humidity	Make sure the ambient temperature is about 0°C to 50°C, and the related humidity is about 20% to 90%.
Oil mist and dust	Make sure there are no oil mist, dust, or condensed water,
Inverter	Check whether the inverter has abnormal overheat or vibration.
Fan	Make sure the fan works normally and is not blocked.
Power supply	Make sure the voltage and frequency of power supply are within permissible scope.
Motor	Check whether the motor has abnormal vibration, overheat, noise, or phase loss.

8.2 Periodic Maintenance

To prevent energy saver failure and ensure its long-term, high-performance and stable operation, users must carry out a periodic check (within six months) for the energy saver.

The check covers:

Check Item	Check Content	Solution
Screws of external cabinet	Whether screws become loose	Tighten them
PCB board	Dust and dirt	Clean dirt or dust with dry compressed air
Fan	Abnormal noise or vibration, or accumulated operation time exceeding 20,000 hours	Clean irrelevant objects Replace the fan
Electrolytic capacitor	Whether the color changes or with foreign smell	Replace the electrolytic capacitor

Check Item	Check Content	Solution
Heat sink	Dust and dirt	Clean dirt or dust with dry compressed air
Power components	Dust and dirt	Clean dirt or dust with dry compressed air

The product warranty is subject to the following provisions:

8.3 Warranty

In case of quality defects, the warranty covers:

8.3.1 For domestic use

- ⌞ A warranty of repair, replacement, or return in one month from the date of shipment;
- ⌞ Repair or replacement in three months from the date of shipment;
- ⌞ Repair in 18 months from the date of shipment.

8.3.2 For overseas use

- ⌞ For overseas use (excluding domestic use), the warranty covers repair in the place of purchasing in 12 months from the date of shipment.

8.3.3 Even within the warranty period, this warranty does not apply to (but paid maintenance service is available for):

- ⌞ Fault or damage caused by inappropriate operation or unauthorized repair or modification;
- ⌞ Fault or damage caused by use against the requirements specified in standards and specifications;
- ⌞ Component aging or fault caused by the use in an environment incompliant with the environment requirements provided in this manual;
- ⌞ Damage arising from natural disasters such as earthquake, fire, wind storm, flood, lightning strike, abnormal voltage or other consequential damage;
- ⌞ Equipment fault or damage when the purchaser fails to pay up the payment for the equipment as agreed.

8.3.4 Life-long paid maintenance service is provided for our products no mater when and where you buy it.

9. INJECTION MOLDING MACHINE INTRODUCTION

9.1 Energy Saving Principle

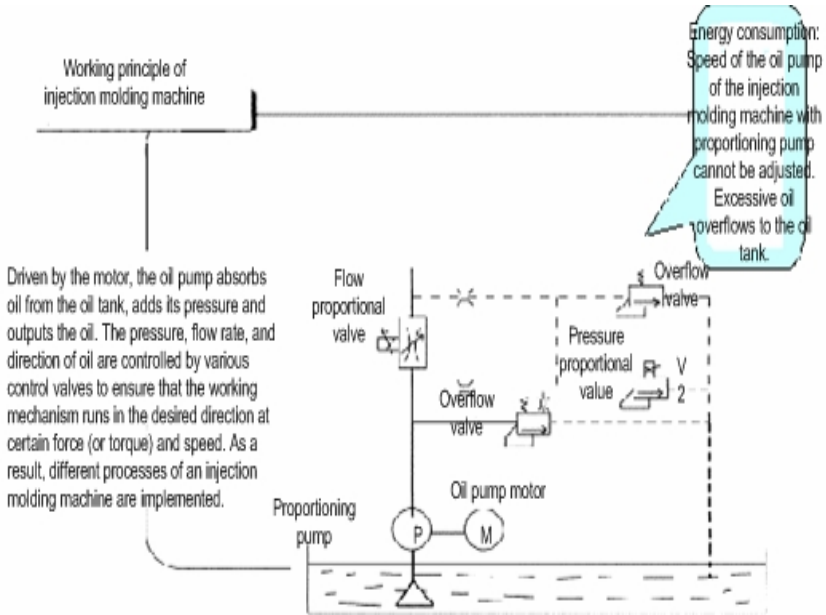

For traditional injection molding machines with constant delivery pumps, valve adjustment is required to change load flow rate and pressure. In this case, input power changes slightly, and a large proportion of energy is consumed by the valve in the form of pressure difference, causing overflow.

CHV110 energy saver can automatically adjust the rotation speed and oil supply quantity of the oil pump based on the current working state of an injection molding machine, like mold clamping, injection, melting, mold opening, and ejector pin, and according to the set pressure and speed requirements, so that the actual oil supply quantity of the oil pump can be consistent with the actual load flow rate of the injection molding machine at any stage. As a result, it minimizes the energy consumption when the motor operates in its load range, eliminates overflow phenomenon, and ensures stable and precise operation of the motor.

Application of CHV110 energy saver makes soft start possible for the motor of injection molding machines, improves the power factor COS ϕ of the motor, and dynamically adjusts the output power of the motor of injection molding machines. In this way, the energy is saved.

9.2. Operation Guide

9.2.1 Switchover between mains supply mode and energy saving mode

9.2.1.1 Energy saving to mains supply operation

The energy saver operates in the energy saving state and the relative indicator is on.

Shut down the main oil pump motor and make sure the motor stops.

Rotate the changeover switch and the mains supply operation indicator becomes on.

The energy saver operates in the mains supply state.

Turn on the main motor of the injection molding machine and perform normal operations.

9.2.1.2 Mains supply to energy saving operation

The energy saver operates in the mains supply state and the mains supply operation indicator is on.

Shut down the main oil pump motor and make sure the motor stops.

Rotate the changeover switch and the energy saving operation indicator becomes on.

The energy saver operates in the energy saving state.

Turn on the main motor of the injection molding machine and perform normal operations.

« Key Point »

Make sure to shut down the motor of the injection molding machine before carrying out the switchover between mains supply operation mode and energy saving operation mode.

9.2.2 Test Stage

With the same mold and materials, the power consumer in the energy saving operation state and in the mains supply operation state can be measured respectively by the switchover between these two modes. Therefore, the energy saving ratio can be calculated. During the switchover, production technicians must be on the site to inspect product quality.

In the energy saving operation state, some injection molding machines may have different technological process flow rate (speed) parameters and pressure parameters from those in the mains supply operation state. Parameters of the injection molding machines in energy saving operation mode are set to values comparatively greater than those set in mains supply operation mode. For these injection molding machines,

parameters have to be adjusted when performing the switchover between mains supply mode and energy saving mode to turn out qualified products.

9.2.3 Normal Operation Stage of Energy Saver

After the energy saver is installed and debugged, always Turn it to be in the energy saving operation mode unless it is required to have a test. It is not necessary for a user to adjust the parameters of the energy saver when a different type of mold is used. No matter what kind of product is produced, it is only required to set the flow (speed) and pressure parameters of the injection molding machine at different stages such as mold clamping, injection, melting, mold opening, and ejector pin, until the qualified products are turned out.

Notice:

- I **Never turn the changeover switch when the equipment is running; otherwise, the energy saver may fail.**
- I **Do not perform the mains supply/energy saving mode switchover frequently; otherwise, it may lead to protection action of the energy saver.**

Do not connect the AC power with output terminals (U, V, W); otherwise, it may cause personal injury or accident.

Do not carry out insulation test between cables of the energy saver.

9.3. Installation and Debugging Procedures

9.3.1 Connection of lines

9.3.1.1 The connection method of the power line is as follows: Correctly identify the main AC contactor for the startup of the motor, disconnect the 3-phase AC wires between the air switch of the injection molding machine and the main AC contactor (Note that if the main AC contactor has other power lines, re-connect them to the air switch), and then connect the <R, S, T> 3-phase power lines of the energy saver to the air switch, and the <U, V, W> 3-phase output lines to the main AC contactor.

9.3.1.2 The connection method of the signal line is as follows: Correctly identify proportional flow signal and proportional pressure signal. When the signal is the current signal, 11A and 11B on the signal acquisition card are input terminals for current signal channel 1, and the corresponding internal channel is AI3. The functional code is P0.03=2, and The corresponding parameters to be set are P5.25~P5.29. Where the 11A is the positive input terminal of differential current and the 11B is the negative input terminal of differential current. 21A and 21B are input terminals for current signal channel 2, and the corresponding internal channel is AI4. The functional code is P0.04=1 and The

corresponding parameters to be set are P5.30-P5.34. Where the 2IA is the positive input terminal of differential current and the 2IB is the negative input terminal of differential current. Besides, the combination mode of these two signal channels is set by the parameter P0.06. Please pay attention to the flow direction of current on the signal line; the user can also make a judgment according to the on/off status of the indicator (the brightness of the indicator varies with the current signal). When the current signal is greater than 0.6A, all indicators become on, indicating the wiring is correct.

9.3.1.3 Upon completion of wiring, test the direction of mains supply mode and energy saving mode, make sure the phase sequence of corresponding motors of the injection molding machine is consistent, and measure signals on two channels with a multimeter to check whether the output is normal.

9.3.2 Parameter setting

Perform motor parameter self-learning. Self-learning steps and precautions are as follows:

9.3.2.1 Enter correctly the parameters on the name plate of the motor. The corresponding functional codes are P2.01 to P2.05.

a) Enter rated power of the motor (very important)

P2.05 (Rated power of the motor)	On the name plate of the motor
----------------------------------	--------------------------------

b) Enter the following four parameters:

P2.01 (Rated frequency of the motor)	On the name plate of the motor
P2.02 (Rated rotation speed of the motor)	On the name plate of the motor
P2.03 (Rated voltage of the motor)	On the name plate of the motor
P2.04 (Rated current of the motor)	On the name plate of the motor

9.3.2.2 Change the following parameters

P0.01 (Keypad control)	0
P0.11 (Acceleration time)	20
P0.12 (Deceleration time)	20

9.3.2.3 Turn the energy saver to be in energy saving state and start the motor of the injection molding machine (ensure the connection between the inverter output and the motor). At this time, you can not operate the injection molding machine (the motor has no load). Then, change the P0.17 to 1. At last, press the <RUN> key, and the inverter starts self-learning. Upon completion of self-learning, the prompt of END appears.

9.3.2.4 After self-learning of motor parameters, check the parameter P2.10. The value shall be less than 60% of the rated current of the motor (P2.04); otherwise, it is abnormal, and it is necessary to confirm whether the motor is free of load when the parameter

self-learning takes place.

9.3.2.5 After the self-learning, the user cannot change parameters in group P2 at will. If any parameter on the name plate of the motor (P2.01-P2.05) changes, it is necessary to conduct the motor parameter self-learning again.

9.3.2.6 If parameters on the name plate of the motor are unavailable, use default parameters. In this case, enters motor power (P2.05) only, and it is unnecessary to carry out parameter self-learning.

9.3.2.7 If the user wants to change the result just after the completion of self-learning, the user can change the rated power of the motor (P2.05) to a different value, and then change it to the current required value. A default value will be generated automatically.

9.3.3 Commissioning steps

Before debugging, conduct commissioning with the keypad to observe whether the system runs normally and whether motor parameters are correct.

9.3.3.1 Set P0.00=0 (Open loop vector control), P0.11=0.1s (acceleration time), P0.10=50.00 Hz. Conduct acceleration and deceleration for several times. If no OC fault occurs, the system is normal.

9.3.3.2 When the motor reaches its rated frequency (P2.01), view the output voltage with the <SHIFT> key on the keypad. If the output voltage is close to the rated voltage of the motor (P2.03), it indicates the system is normal and motor parameters are correct. If the output voltage is excessively high, appropriately reduce the no-load current of the motor (P2.10); if the output voltage is excessively low, appropriately increase the no-load current of the motor (P2.10)

9.3.3.3 When the motor reaches half of its rated frequency (P2.01), view the output voltage. If the output voltage is about half of the rated voltage, it indicates the system is normal; otherwise, motor parameters are incorrect. If the output voltage is too high, appropriately reduce the no-load current of the motor (P2.10); if the output voltage is too low, appropriately increase the no-load current of the motor (P2.10).

9.3.4 Debugging contents

Enter the corresponding functional code and set the parameters by referring to the following settings:

9.3.4.1 Modify the following basic parameters:

Functional Code	Reference Set Value	Functional Code	Reference Set Value	Functional Code	Reference Set Value
P0.00	0	P0.06	3	P1.14	0
P0.01	1	P0.08		P4.12	1

Functional Code	Reference Set Value	Functional Code	Reference Set Value	Functional Code	Reference Set Value
P0.02	2	P0.09		P7.04	0
P0.03	2	P0.11	0.7	P8.16	3
P0.04	1	P0.12	1.5	P8.18	1.0

9.3.4.2 Parameters for adjusting signal amplification rate are as follows:

Functional Code	Function Description	Functional Code	Function Description
P5.25	Lower limit of channel 1	P5.30	Lower limit of channel 2
P5.26	Setting corresponding to the lower limit of channel 1	P5.31	Setting corresponding to the lower limit of channel 2
P5.27	Upper limit of channel 1	P5.32	Upper limit of channel 2
P5.28	Setting corresponding to the upper limit of channel 1	P5.33	Setting corresponding to the upper limit of channel 2

When the energy saver runs in the mains supply mode, flow and pressure parameters can be adjusted separately. Change P0.06 to be 0, observe flow parameters of channel 1, Which is compared with the analog frequency of the energy saver. If they are inconsistent, adjust the parameters P5.25 to P5.28. After that, Change P0.06 to be 1, observe pressure parameters of channel 2, Which is compared with the analog frequency of the energy saver. If they are inconsistent adjust the parameters P5.30 to P5.33. At last, Change P0.06 to be 3, which is the standard comparative input for two channels.

9.3.4.3 During the use of the energy saver, if protection function is incorrectly enabled, motor parameters may be incorrect. Change P0.00 to be 2 (V/F control) and try to identify the cause.

9.3.4-4 Make sure the motor is in the stop state during the switchover between the mains supply mode and energy saving mode; otherwise, the inverter will generate an OC fault.

9.3.4.5 Special treatment

If multi-step speed is required for the commissioning of some injection molding machines, try the following methods:

Set the following parameters through the JOG terminal (S2):

Functional Code	Function Description
P5.03 (S2 terminal function selection)	4 (FWD JOG); 5 (REV JOG)
P8.06 (JOG run frequency)	Set according to actual situations (less than the maximum frequency)

P8.07 (JOG acceleration time)	0.7
P8.08 (JOG deceleration time)	2.0

Set the following parameters through the multi-step speed terminal (S4):

Functional Code	Function Description
P5.05 (S4 terminal function selection)	16 (Multi-step speed terminal 1)
PA.04 (Multi-step speed 1)	

10. LIST OF FUNCTION PARAMETERS

Notice:

- I PE group is factory reserved, users are forbidden to access these parameters.
- I The column “Modify” determines the parameter can be modified or not.
 - “○” indicates that his parameter can be modified all the time.
 - “⊙” indicates that this parameter cannot be modified during the inverter is running.
 - “●” indicates that this parameter is read only.
- I “Factory Setting” indicates the value of each parameter while restoring the factory parameters, but those detected parameters or record values cannot be restored.

Function Code	Name	Description	Factory Setting	Modify	LCD Display
P0 Group: Basic Function					
P0.00	Speed control mode	0:Sensorless vector control 1:Vector control With PG 2:V/F control	0	⊙	CONTROL MODE
P0.01	Run command source	0: Keypad 1: Terminal 2: Communication	0	⊙	RUN COMMAND
P0.02	UP/DOWN setting	0: Valid, save UP/DOWN value when power off 1: Valid, do not save UP/DOWN value when power off 2: Invalid 3: Valid during running, clear when power off	0	⊙	UP/DOWN SETTING

Function Code	Name	Description	Factory Setting	Modify	LCD Display
P0.03	Frequency A command source	0: Keypad 1: AI1 2: AI3 3: HDI1 4: Simple PLC 5: Multi-Step speed 6: PID 7: Communication	0	<input checked="" type="radio"/>	FREQ SOURCE A
P0.04	Frequency B command source	0: AI2 1: AI4 2: HDI2	0	<input checked="" type="radio"/>	FREQ SOURCE B
P0.05	Scale of frequency B command	0: Maximum frequency 1: Frequency A command	0	<input type="radio"/>	FREQ B SCALE
P0.06	Frequency command selection	0: A 1: B 2: A+B 3: Max (A, B)	0	<input type="radio"/>	FREQ SELECTION
P0.07	Maximum frequency	10.0~400.00Hz	50.00Hz	<input checked="" type="radio"/>	MAX FREQ
P0.08	Upper frequency limit	P0.09~P0.07	50.00Hz	<input type="radio"/>	UP FREQ LIMIT
P0.09	Lower frequency limit	0.00Hz~ 0.08	0.00Hz	<input type="radio"/>	LOW FREQ LIMIT
P0.10	Keypad reference frequency	0.00 Hz ~ P0.08	50.00Hz	<input type="radio"/>	KEYPAD REF FREQ
P0.11	Acceleration time 0	0.0~3600.0s	20.0s	<input type="radio"/>	ACC TIME 0
P0.12	Deceleration time 0	0.0~3600.0s	20.0s	<input type="radio"/>	DEC TIME 0
P0.13	Running direction selection	0: Forward 1: Reverse 2: Forbid reverse	0	<input checked="" type="radio"/>	RUN DIRECTION

Function Code	Name	Description	Factory Setting	Modify	LCD Display
P0.14	Carrier frequency	1.0~16.0kHz	Depend on model	<input type="radio"/>	CARRIER FREQ
P0.15	PWM mode	0:Fixed 1:Random	0	<input type="radio"/>	PWM MODE
P0.16	Carrier frequency adjust based on temperature	0: Disabled 1: Enabled	0	<input checked="" type="radio"/>	AUTO ADJUST
P0.17	Motor parameters autotuning	0: No action 1: Rotation autotuning 2: Static autotuning	0	<input checked="" type="radio"/>	AUTOTUNING
P0.18	Restore parameters	0: No action 1: Restore factory setting 2: Clear fault records 3:Restore parameters for injection molding machine	0	<input checked="" type="radio"/>	RESTORE PARA
P1 Group: Start and Stop Control					
P1.00	Start Mode	0: Start directly 1: DC braking and start 2: Speed tracking and start	0	<input checked="" type="radio"/>	START MODE
P1.01	Starting frequency	0.00~10.0Hz	0.00Hz	<input checked="" type="radio"/>	START FREQ
P1.02	Hold time of starting frequency	0.0~50.0s	0.0s	<input checked="" type="radio"/>	HOLD TIME
P1.03	DC Braking current before start	0.0~150.0%	0.0%	<input checked="" type="radio"/>	START BRAK CURR
P1.04	DC Braking time before start	0.0~50.0s	0.0s	<input checked="" type="radio"/>	START BRAK TIME
P1.05	Acceleration /Deceleration mode	0:Linear 1:S curve	0	<input checked="" type="radio"/>	ACC/DEC MODE

Function Code	Name	Description	Factory Setting	Modify	LCD Display
P1.06	Start section of S curve	0.0~40.0% (ACC/DEC time)	30.0%	☉	START SECTION
P1.07	End section of S curve	0.0~40.0% (ACC/DEC time)	30.0%	☉	END SECTION
P1.08	Stop Mode	0:Deceleration to stop 1:Coast to stop	0	○	STOP MODE
P1.09	Starting frequency of DC braking	0.00~P0.07	0.00Hz	○	STOP BRAK FREQ
P1.10	Waiting time before DC braking	0.0~50.0s	0.0s	○	STOP BRAK DELAY
P1.11	DC braking current	0.0~150.0%	0.0%	○	STOP BRAK CURR
P1.12	DC braking time	0.0~50.0s	0.0s	○	STOP BRAK TIME
P1.13	Dead time of FWD/REV	0.0~3600.0s	0.0s	○	FWD/REV DEADTIME
P1.14	Action when running frequency is less than lower frequency limit	0: Running at the lower frequency limit 1: Stop 2: Stand-by	0	☉	ACT(FREQ< P0.09)
P1.15	Restart after power off	0: Disabled 1: Enabled	0	○	RESTART
P1.16	Delay time for restart	0.0~3600.0s	0.0s	○	DELAY TIME
P2 Group: Motor Parameters					
P2.00	Inverter model	0:G model 1: P model	0	☉	INVERTER MODEL
P2.01	Motor rated frequency	0.01Hz~P0.07	50.00Hz	☉	MOTOR RATE FREQ

Function Code	Name	Description	Factory Setting	Modify	LCD Display
P2.02	Motor rated speed	0~36000rpm	1460 rpm	☉	MOTOR RATE SPEED
P2.03	Motor rated voltage	0~3000V	Depend on model	☉	MOTOR RATE VOLT
P2.04	Motor rated current	0.1~2000.0A	Depend on model	☉	MOTOR RATE CURR
P2.05	Motor rated power	1.5~900.0kW	Depend on model	☉	MOTOR RATE POWER
P2.06	Motor stator resistance	0.001~65.535Ω	Depend on model	○	STATOR RESISTOR
P2.07	Motor rotor resistance	0.001~65.535Ω	Depend on model	○	ROTOR RESISTOR
P2.08	Motor leakage inductance	0.1~6553.5mH	Depend on model	○	LEAK INDUCTOR
P2.09	Motor mutual inductance	0.1~6553.5mH	Depend on model	○	MUTUAL INDUCTOR
P2.10	Current without load	0.01~655.35A	Depend on model	○	NO LOAD CURR
P3 Group: Vector Control					
P3.00	ASR proportional gain K_p1	0~100	20	○	ASR Kp1
P3.01	ASR integral time K_i1	0.01~10.00s	0.50s	○	ASR Ki1
P3.02	ASR switching point 1	0.00Hz~P3.05	5.00Hz	○	ASR SWITCHPOINT1
P3.03	ASR proportional gain K_p2	0~100	25	○	ASR Kp2
P3.04	ASR integral time K_i2	0.01~10.00s	1.00s	○	ASR Ki2

Function Code	Name	Description	Factory Setting	Modify	LCD Display
P3.05	ASR switching point 2	P3.02~P0.07	10.00Hz	<input type="radio"/>	ASR SWITCHPOINT2
P3.06	ACR proportional gain P	0~65535	500	<input type="radio"/>	ACR P
P3.07	ACR integral gain I	0~65535	500	<input type="radio"/>	ACR I
P3.08	Speed detection filter time	0.00~5.00s	0.00s	<input type="radio"/>	FEEDBACK FILTER
P3.09	Slip compensation rate of VC	50.0~200.0%	100%	<input type="radio"/>	VC SLIP COMP
P3.10	PG parameter	1~65535	1000	<input checked="" type="radio"/>	PG PARAMETER
P3.11	PG direction selection	0:Forward 1:Reverse	0	<input checked="" type="radio"/>	PG DIRECTION
P3.12	Torque setting source	0:Disabled 1: Keypad 2:A11 3:A12 4:A13 5:A14 6:HDI1 7:HDI2 8:Communication	0	<input type="radio"/>	TORQUE SETTING
P3.13	Keypad torque setting	-100.0%~100.0%	50.0%	<input type="radio"/>	KEYPAD TORQUE SET
P3.14	Torque limit	0.0~200.0%(rated current of inverter)	150.0%	<input type="radio"/>	TORQUE LIMIT
P4 Group: V/F Control					

Function Code	Name	Description	Factory Setting	Modify	LCD Display
P4.00	V/F curve selection	0: Linear curve 1: User-defined curve 2: Torque_stepdown curve (1.3 order) 3: Torque_stepdown curve (1.7 order) 4: Torque_stepdown curve (2.0 order)	0	☉	V/F CURVE
P4.01	Torque boost	0.0%: auto 0.1%~10.0%	1.0%	○	TORQUE BOOST
P4.02	Torque boost cut-off	0.0%~50.0% (motor rated frequency)	20.0%	☉	BOOST CUT-OFF
P4.03	V/F frequency 1	0.00Hz~ P4.05	5.00Hz	☉	V/F FREQ 1
P4.04	V/F voltage 1	0.0%~100.0%	10.0%	☉	V/F VOLTAGE 1
P4.05	V/F frequency 2	P4.03~ P4.07	30.00Hz	☉	V/F FREQ 2
P4.06	V/F voltage 2	0.0%~100.0%	60.0%	☉	V/F VOLTAGE 2
P4.07	V/F frequency 3	P4.05~ P2.01	50.00Hz	☉	V/F FREQ 3
P4.08	V/F voltage 3	0.0%~100.0%	100.0%	☉	V/F VOLTAGE 3
P4.09	V/F slip compensation	0.00~10.00Hz	0.0Hz	○	V/F SLIP COMP
P4.10	AVR function	0: Disabled 1: Enabled all the time 2: Disabled during deceleration	1	○	AVR
P4.11	Auto energy saving selection	0: Disabled 1: Enabled	0	○	ENERGY SAVING
P4.12	FWD/REV enable option when power on	0: Disabled 1: Enabled	0	○	FWD/REV ENABLE

Function Code	Name	Description	Factory Setting	Modify	LCD Display
P5 Group: Input Terminals					
P5.00	HDI selection	0: HDI1 and HDI2 are high speed pulse input. 1: HDI1 is ON-OFF input, HDI2 is high speed pulse input. 2: HDI2 is ON-OFF input, HDI1 is high speed pulse input. 3: HDI1 and HDI2 are ON-OFF input.	0	☉	HDI SELECTION
P5.01	Input selection	0: Concrete 1: Virtual	0	☉	INPUT SELECTION
P5.02	S1 Terminal function	0:Invalid 1:Forward 2:Reverse 3:3-wire control	1	☉	S1 FUNCTION
P5.03	S2 Terminal function	4:Jog forward 5:Jog reverse	4	☉	S2 FUNCTION
P5.04	S3 Terminal function	6:Coast to stop 7:Reset fault	7	☉	S3 FUNCTION
P5.05	S4 Terminal function	8:Pause running 9:External fault input	0	☉	S4 FUNCTION
P5.06	S5 Terminal function	10:UP command 11:DOWN command	0	☉	S5 FUNCTION
P5.07	HDI1 terminal function	12:Clear UP/DOWN 13:Switch between A and B	0	☉	HDI1 FUNCTION
P5.08	HDI2 terminal function	14:Switch between A and A+B	0	☉	HDI2 FUNCTION
P5.09	S6 Terminal function	15:Switch between B and A+B	0	☉	S6 FUNCTION

Function Code	Name	Description	Factory Setting	Modify	LCD Display
P5.10	S7 Terminal function	A+B 16: Multi-step speed reference1 17: Multi-step speed reference2 18: Multi-step speed reference3	0	☉	S7 FUNCTION
P5.11	S8 Terminal function	19: Multi-step speed reference4 20: Multi-step speed pause 21: ACC/DEC time selection 1 22: ACC/DEC time selection 2 23: Reset simple PLC when stop 24: Pause simple PLC 25: Pause PID 26: Pause traverse operation 27: Reset traverse operation 28: Reset counter 29: Reset length 30: ACC/DEC ramp hold 31: Disable torque control 32~52: Water supply control 53: 3-wire jog control 54~55: reversed	0	☉	S8 FUNCTION
P5.12	ON-OFF filter times	1~10	5	○	Sx FILTER TIMES

Function Code	Name	Description	Factory Setting	Modify	LCD Display
P5.13	FWD/REV control mode	0: 2-wire control mode 1 1: 2-wire control mode 2 2: 3-wire control mode 1 3: 3-wire control mode 2	0	<input checked="" type="radio"/>	FWD/REV CONTROL
P5.14	UP/DOWN setting change rate	0.01~50.00Hz/s	0.50Hz/s	<input type="radio"/>	UP/DOWN RATE
P5.15	AI1 lower limit	0.00V~10.00V	0.00V	<input type="radio"/>	AI1 LOW LIMIT
P5.16	AI1 lower limit corresponding setting	-100.0%~100.0%	0.0%	<input type="radio"/>	AI1 LOW SETTING
P5.17	AI1 upper limit	0.00V~10.00V	10.00V	<input type="radio"/>	AI1 UP LIMIT
P5.18	AI1 upper limit corresponding setting	-100.0%~100.0%	100.0%	<input type="radio"/>	AI1 UP SETTING
P5.19	AI1 filter time constant	0.00s~10.00s	0.10s	<input type="radio"/>	AI1 FILTER TIME
P5.20	AI2 lower limit	0.00V~10.00V	0.00V	<input type="radio"/>	AI2 LOW LIMIT
P5.21	AI2 lower limit corresponding setting	-100.0%~100.0%	0.0%	<input type="radio"/>	AI2 LOW SETTING
P5.22	AI2 upper limit	0.00V~10.00V	5.00V	<input type="radio"/>	AI2 UP LIMIT
P5.23	AI2 upper limit corresponding setting	-100.0%~100.0%	100.0%	<input type="radio"/>	AI2 UP SETTING
P5.24	AI2 filter time constant	0.00s~10.00s	0.10s	<input type="radio"/>	AI2 FILTER TIME
P5.25	AI3 lower limit	-10.00V ~10.00V	0.00V	<input type="radio"/>	AI3 LOW LIMIT

Function Code	Name	Description	Factory Setting	Modify	LCD Display
P5.26	AI3 lower limit corresponding setting	-100.0%~100.0%	0.0%	<input type="radio"/>	AI3 LOW SETTING
P5.27	AI3 upper limit	-10.00V ~10.00V	10.00V	<input type="radio"/>	AI3 UP LIMIT
P5.28	AI3 upper limit corresponding setting	-100.0%~100.0%	100.0%	<input type="radio"/>	AI3 UP SETTING
P5.29	AI3 filter time constant	0.00s~10.00s	0.10s	<input type="radio"/>	AI3 FILTER TIME
P5.30	AI4 lower limit	0.00V~10.00V	0.00V	<input type="radio"/>	AI4 LOW LIMIT
P5.31	AI4 lower limit corresponding setting	-100.0%~100.0%	0.0%	<input type="radio"/>	AI4 LOW SETTING
P5.32	AI4 upper limit	0.00V~10.00V	10.00V	<input type="radio"/>	AI4 UP LIMIT
P5.33	AI4 upper limit corresponding setting	-100.0%~100.0%	100.0%	<input type="radio"/>	AI4 UP SETTING
P5.34	AI4 filter time constant	0.00s~10.00s	0.10s	<input type="radio"/>	AI4 FILTER TIME
P5.35	HDI1 function selection	0: Reference input 1: Counter input	0	<input checked="" type="radio"/>	HDI1 FUNCTION
P5.36	HDI2 function selection	2: Length input 3: Reserved 4: Reserved	0	<input checked="" type="radio"/>	HDI2 FUNCTION
P5.37	HDI1 lower limit	0.0 kHz ~50.0kHz	0.0KHz	<input type="radio"/>	HDI1 LOW LIMIT
P5.38	HDI1 lower limit corresponding setting	-100.0%~100.0%	0.0%	<input type="radio"/>	HDI1 LOW SETTING
P5.39	HDI1 upper limit	0.0 kHz ~50.0kHz	50.0KHz	<input type="radio"/>	HDI1 UP LIMIT

Function Code	Name	Description	Factory Setting	Modify	LCD Display
P5.40	HDI1 upper limit corresponding setting	-100.0%~100.0%	100.0%	<input type="radio"/>	HDI1 UP SETTING
P5.41	HDI1 filter time constant	0.00s~10.00s	0.10s	<input type="radio"/>	HDI1 FILTER TIME
P5.42	HDI2 lower limit	0.0 kHz ~50.0kHz	0.0KHz	<input type="radio"/>	HDI2 LOW LIMIT
P5.43	HDI2 lower limit corresponding setting	-100.0%~100.0%	0.0%	<input type="radio"/>	HDI1 LOW SETTING
P5.44	HDI2 upper limit	0.0 kHz ~50.0kHz	50.0KHz	<input type="radio"/>	HDI2 UP LIMIT
P5.45	HDI2 upper limit corresponding setting	-100.0%~100.0%	100.0%	<input type="radio"/>	HDI2 UP SETTING
P5.46	HDI2 filter time constant	0.00s~10.00s	0.10s	<input type="radio"/>	HDI2 FILTER TIME
P6 Group: Output Terminals					
P6.00	HDO selection	0: High-speed pulse output 1: ON-OFF output	0	<input checked="" type="radio"/>	HDO SELECTION
P6.01	Y1 output selection	0: NO output 1: Run forward	1	<input type="radio"/>	Y1 SELECTION
P6.02	Y2 output selection	2: Run reverse 3: Fault output	0	<input type="radio"/>	Y2 SELECTION
P6.03	HDO ON-OFF output selection	4: Motor overload 5: Inverter overload	0	<input type="radio"/>	HDO SELECTION
P6.04	Relay 1 output selection	6: FDT reached 7: Frequency reached	3	<input type="radio"/>	RO1 SELECTION

Function Code	Name	Description	Factory Setting	Modify	LCD Display
P6.05	Relay 2 output selection	8: Zero speed running 9: Preset count value reached	0	<input type="radio"/>	RO2 SELECTION
P6.06	Relay 3 output selection	10: Specified count value reached 11: Length reached 12: PLC cycle completed 13: Running time reached 14: Upper frequency limit reached 15: Lower frequency limit reached 16: Ready 17: Auxiliary motor1 started 18: Auxiliary motor2 started 19: Motor running 20: Stop pulse output 21~31: Reserved	0	<input type="radio"/>	RO3 SELECTION
P6.07	AO1 function selection	0: Running frequency 1: Reference frequency 2: Motor speed	0	<input type="radio"/>	AO1 SELECTION
P6.08	AO2 function selection	3: Output current 4: Output voltage 5: Output power 6: Output torque	0	<input type="radio"/>	AO2 SELECTION

Function Code	Name	Description	Factory Setting	Modify	LCD Display
P6.09	HDO function selection	7: AI1 voltage 8: AI2 voltage/current 9: AI3 voltage 10: AI4 voltage 11: HDI1 frequency 12: HDI2 frequency 13: Length value 14: Count value	0	<input type="radio"/>	HDO SELECTION
P6.10	AO1 lower limit	0.0%~100.0%	0.0%	<input type="radio"/>	AO1 LOW LIMIT
P6.11	AO1 lower limit corresponding output	0.00V ~10.00V	0.00V	<input type="radio"/>	AO1 LOW OUTPUT
P6.12	AO1 upper limit	0.0%~100.0%	100.0%	<input type="radio"/>	AO1 UP LIMIT
P6.13	AO1 upper limit corresponding output	0.00V ~10.00V	10.00V	<input type="radio"/>	AO1 UP OUTPUT
P6.14	AO2 lower limit	0.0%~100.0%	0.0%	<input type="radio"/>	AO2 LOW LIMIT
P6.15	AO2 lower limit corresponding output	0.00V ~10.00V	0.00V	<input type="radio"/>	AO2 LOW OUTPUT
P6.16	AO2 upper limit	0.0%~100.0%	100.0%	<input type="radio"/>	AO1 UP LIMIT
P6.17	AO2 upper limit corresponding output	0.00V ~10.00V	10.00V	<input type="radio"/>	AO2 UP OUTPUT
P6.18	HDO lower limit	0.0%~100.0%	0.0%	<input type="radio"/>	HDO LOW LIMIT
P6.19	HDO lower limit corresponding output	0.0 ~ 50.0kHz	0.0kHz	<input type="radio"/>	HDO LOW OUTPUT

Function Code	Name	Description	Factory Setting	Modify	LCD Display
P6.20	HDO upper limit	0.0%~100.0%	100.0%	<input type="radio"/>	HDO UP LIMIT
P6.21	HDO upper limit corresponding output	0.0 ~ 50.0kHz	50.0kHz	<input type="radio"/>	HDO UP OUTPUT
P7 Group: Display Interface					
P7.00	User password	0~65535	0	<input type="radio"/>	USER PASSWORD
P7.01	LCD language selection	0: Chinese 1: English	0	<input type="radio"/>	LANGUAGE SELECT
P7.02	Parameter copy	0: Invalid 1: Upload parameters to LCD 2: Download parameters from LCD	0	<input checked="" type="radio"/>	PARA COPY
P7.03	QUICK/JOG function selection	0: Quick debugging mode 1: FDW/REV switching 2: Jog 3: Clear UP/DOWN setting	0	<input checked="" type="radio"/>	QUICK/JOG FUNC
P7.04	STOP/RST function selection	0: Valid when keypad control (P0.01=0) 1: Valid when keypad or terminal control (P0.01=0 or 1) 2: Valid when keypad or communication control (P0.01=0 or 2) 3: Always valid	0	<input type="radio"/>	STOP/RST FUNC

Function Code	Name	Description	Factory Setting	Modify	LCD Display
P7.05	Keypad display selection	0: Preferential to external keypad 1: Both display, only external key valid. 2: Both display, only local key valid. 3: Both display and key valid.	0	○	KEYPAD DISPLAY

Function Code	Name	Description	Factory Setting	Modify	LCD Display
P7.06	Running status display selection	1.Output frequency 2.Reference frequency 3.DC bus voltage 4.Output voltage 5.Output current Other parameters display is determined by 16 bit binary digit BIT0: Rotation speed BIT1: Output power BIT2: Output torque BIT3: PID preset BIT4: PID feedback BIT5: Input terminal status BIT6: Output terminal status BIT7: AI1 BIT8: AI2 BIT9: AI3 BIT10: AI4 BIT11: HDI1 BIT12: HDI2 BIT13: Step No. of PLC BIT14: Length value BIT15: Count value	0x00FF	○	RUNNING DISPLAY

Function Code	Name	Description	Factory Setting	Modify	LCD Display
P7.07	Stop status display selection	BIT0: Reference frequency BIT1: DC bus voltage BIT2: Input terminal status BIT3: Output terminal status BIT4: PID preset BIT5: PID feedback BIT6: AI1 BIT7: AI2 BIT8: AI3 BIT9: AI4 BIT10: HDI1 BIT11: HDI2 BIT12: Step No. of PLC BIT13: Length value BIT14: Reserved BIT15: Reserved	0x00FF	○	STOP DISPLAY
P7.08	Rectifier module temperature	0~100.0℃		●	RECTIFIER TEMP
P7.09	IGBT module temperature	0~100.0℃		●	IGBT TEMP
P7.10	MCU software version	Factory setting		●	MCU VERSION
P7.11	DSP software version	Factory setting		●	DSP VERSION
P7.12	Accumulated running time	0~65535h		●	TOTAL RUN TIME

Function Code	Name	Description	Factory Setting	Modify	LCD Display
P7.13	Third latest fault type	0: Not fault 1: IGBT Ph-U fault(OUT1) 2: IGBT Ph-V fault(OUT2) 3: IGBT Ph-W fault(OUT3) 4: Over-current when acceleration(OC1) 5: Over-current when deceleration(OC2)		●	3rd LATEST FAULT
P7.14	Second latest fault type	6: Over-current when constant speed running(OC3) 7: Over-voltage when acceleration(OV1) 8: Over-voltage when deceleration(OV2) 9: Over-voltage when constant speed running(OV3) 10: DC bus Under-voltage(UV) 11: Motor overload (OL1) 12: Inverter overload (OL2)		●	2nd LATEST FAULT

Function Code	Name	Description	Factory Setting	Modify	LCD Display
P7.15	Latest fault type	13: Input phase failure (SPI) 14: Output phase failure (SPO) 15: Rectify overheat (OH1) 16: IGBT overheat (OH2) 17: External fault (EF) 18: Communication fault (CE) 19: Current detection fault (ITE) 20: Autotuning fault (TE) 21: Encoder fault(PCE) 22: Encoder reverse fault(PCDE) 23: System fault(OPSE) 24: : EEPROM fault (EEP) 25: PID feedback fault (PIDE) 26: Brake unit fault (BCE) 27: Trial time reached(END) 28: LCD disconnected(LCD-E) 29: Clock chip fault(TI-E) 30: Reserved		●	CURRENT FAULT
P7.16	Output frequency at current fault			●	FAULT FREQ
P7.17	Output current at current fault			●	FAULT CURR

Function Code	Name	Description	Factory Setting	Modify	LCD Display
P7.18	DC bus voltage at current fault			●	FAULT DC VOLT
P7.19	Input terminal status at current fault			●	FAULT Sx STATUS
P7.20	Output terminal status at current fault			●	FAULT DO STATUS
P8 Group: Enhanced Function					
P8.00	Acceleration time 1	0.0~3600.0s	20.0s	○	ACC TIME 1
P8.01	Deceleration time 1	0.0~3600.0s	20.0s	○	DEC TIME 1
P8.02	Acceleration time 2	0.0~3600.0s	20.0s	○	ACC TIME 2
P8.03	Deceleration time 2	0.0~3600.0s	20.0s	○	DEC TIME 2
P8.04	Acceleration time 3	0.0~3600.0s	20.0s	○	ACC TIME 3
P8.05	Deceleration time 3	0.0~3600.0s	20.0s	○	DEC TIME 3
P8.06	Jog reference	0.00~P0.07	5.00Hz	○	JOG REF
P8.07	Jog Acceleration time	0.0~3600.0s	20.0s	○	JOG ACC TIME
P8.08	Jog Deceleration time	0.0~3600.0s	20.0s	○	JOG DEC TIME
P8.09	Skip frequency 1	0.00~P0.07	0.00Hz	○	SKIP FREQ 1
P8.10	Skip frequency 2	0.00~P0.07	0.00Hz	○	SKIP FREQ 2
P8.11	Skip frequency bandwidth	0.00~P0.07	0.00Hz	○	SKIP FREQ RANGE

Function Code	Name	Description	Factory Setting	Modify	LCD Display
P8.12	Traverse amplitude	0.0~100.0% (with reference to P0.10)	0.0%	<input type="radio"/>	TRAV AMPLITUDE
P8.13	Jitter frequency	0.0~50.0%	0.0%	<input type="radio"/>	JITTER FREQ
P8.14	Rise time of traverse	0.1~3600.0s	5.0s	<input type="radio"/>	TRAV RISE TIME
P8.15	Fall time of traverse	0.1~3600.0s	5.0s	<input type="radio"/>	TRAV FALL TIME
P8.16	Auto reset times	0~3	0	<input type="radio"/>	AUTO RESET TIMES
P8.17	Fault relay action	0: Disabled 1: Enabled	0	<input type="radio"/>	FAULT ACTION
P8.18	Reset interval	0.1~100.0s	1.0s	<input type="radio"/>	RESET INTERVAL
P8.19	Preset length	1~65535	1000	<input type="radio"/>	PRESET LENGTH
P8.20	Actual length	0~65535	0	<input type="radio"/>	ACTUAL LENGTH
P8.21	Number of pulse per cycle	0.1~6553.5	100.0	<input type="radio"/>	PULSE NUMBER
P8.22	Preset count value	1~65535	1000	<input type="radio"/>	PRESET COUNT
P8.23	Specified count value	1~65535	1000	<input type="radio"/>	SPECIFIED COUNT
P8.24	Preset running time	0~65535h	65535 h	<input type="radio"/>	RUNNING TIME
P8.25	FDT level	0.00~ P0.07	50.00Hz	<input type="radio"/>	FDT LEVEL
P8.26	FDT lag	0.0~100.0%	5.0%	<input type="radio"/>	FDT LAG
P8.27	Frequency arrive detecting range	0.0~100.0% (maximum frequency)	0.0%	<input type="radio"/>	FAR RANGE

Function Code	Name	Description	Factory Setting	Modify	LCD Display
P8.28	Droop control	0.00~10.00Hz	0.00Hz	<input type="radio"/>	DROOP CONTROL
P8.29	Auxiliary motor selection	0: Invalid 1: Motor 1 valid 2: Motor 2 valid 3: Both valid	0	<input checked="" type="radio"/>	AUXILIARY MOTOR
P8.30	Auxiliary motor1 START/STOP delay time	0.0~3600.0s	5.0s	<input type="radio"/>	MOTOR 1 DELAY
P8.31	Auxiliary motor2 START/STOP delay time	0.0~3600.0s	5.0s	<input type="radio"/>	MOTOR 2 DELAY
P8.32	Brake threshold voltage	320.0~750.0V	700.0V	<input type="radio"/>	BRAK VOLT
P8.33	Low-frequency threshold of restraining oscillation	0~9999	1000	<input type="radio"/>	LO FREQ RESTRAIN
P8.34	High-frequency threshold of restraining oscillation	0~9999	1000	<input type="radio"/>	HI FREQ RESTRAIN
P9 Group: PID Control					
P9.00	PID preset source selection	0: Keypad 1: AI1 2: AI2 3: AI3 4: AI4 5: HDI1 6: HDI2 7: Communication 8: Simple PLC	0	<input type="radio"/>	PID PRESET

Function Code	Name	Description	Factory Setting	Modify	LCD Display
P9.01	Keypad PID preset	0.0%~100.0%	0.0%	<input type="radio"/>	KEYPAD PID SET
P9.02	PID feedback source selection	0: AI1 1: AI2 2: AI3 3: AI4 4: AI1-AI2 5: AI3-AI4 6: HDI1 7: HDI2 8: HDI1-HDI2 9: Communication	0	<input type="radio"/>	PID FEEDBACK
P9.03	PID output characteristics	0: Positive 1: Negative	0	<input type="radio"/>	PID OUTPUT
P9.04	Proportional gain (Kp)	0.00~100.00	0.10	<input type="radio"/>	PROPORTION GAIN
P9.05	Integral time (Ti)	0.01~10.00s	0.10s	<input type="radio"/>	INTEGRAL TIME
P9.06	Differential time (Td)	0.00~10.00s	0.00s	<input type="radio"/>	DIFFERENTIAL TIME
P9.07	Sampling cycle (T)	0.01~100.00s	0.50s	<input type="radio"/>	SAMPLING CYCLE
P9.08	Bias limit	0.0~100.0%	0.0%	<input type="radio"/>	BIAS LIMIT
P9.09	PID output filter time	0.00~10.00s	0.00	<input type="radio"/>	OUTPUT FILTER
P9.10	Feedback lost detecting value	0.0~100.0%	0.0%	<input type="radio"/>	FEEDBACK LOST
P9.11	Feedback lost detecting time	0.0~3600.0s	1.0s	<input type="radio"/>	FEEDBACK LOST(t)
PA Group: Multi-step Speed Control					

Function Code	Name	Description	Factory Setting	Modify	LCD Display
PA.00	Simple PLC mode	0: Stop after one cycle 1: Hold last frequency after one cycle 2: Circular run	0	<input type="radio"/>	PLC MODE
PA.01	Simple PLC status saving selection	0: Not saved 1: Saved 2: Not saved when power off, saved when stop	0	<input type="radio"/>	STATUS SAVING
PA.02	Multi-step speed 0	-100.0~100.0%	0.0%	<input type="radio"/>	MULTI-SPEED 0
PA.03	0 th Step running time	0.0~6553.5s(h)	0.0s	<input type="radio"/>	RUNNING TIME 0
PA.04	Multi-step speed 1	-100.0~100.0%	0.0%	<input type="radio"/>	MULTI-SPEED 1
PA.05	1 st Step running time	0.0~6553.5s(h)	0.0s	<input type="radio"/>	RUNNING TIME 1
PA.06	Multi-step speed 2	-100.0~100.0%	0.0%	<input type="radio"/>	MULTI-SPEED 2
PA.07	2 nd Step running time	0.0~6553.5s(h)	0.0s	<input type="radio"/>	RUNNING TIME 2
PA.08	Multi-step speed 3	-100.0~100.0%	0.0%	<input type="radio"/>	MULTI-SPEED 3
PA.09	3 rd Step running time	0.0~6553.5s(h)	0.0s	<input type="radio"/>	RUNNING TIME 3
PA.10	Multi-step speed 4	-100.0~100.0%	0.0%	<input type="radio"/>	MULTI-SPEED 4
PA.11	4 th Step running time	0.0~6553.5s(h)	0.0s	<input type="radio"/>	RUNNING TIME 4
PA.12	Multi-step speed 5	-100.0~100.0%	0.0%	<input type="radio"/>	MULTI-SPEED 5
PA.13	5 th Step running time	0.0~6553.5s(h)	0.0s	<input type="radio"/>	RUNNING TIME 5

Function Code	Name	Description	Factory Setting	Modify	LCD Display
PA.14	Multi-step speed 6	-100.0~100.0%	0.0%	<input type="radio"/>	MULTI-SPEED 6
PA.15	6 th Step running time	0.0~6553.5s(h)	0.0s	<input type="radio"/>	RUNNING TIME 6
PA.16	Multi-step speed 7	-100.0~100.0%	0.0%	<input type="radio"/>	MULTI-SPEED 7
PA.17	7 th Step running time	0.0~6553.5s(h)	0.0s	<input type="radio"/>	RUNNING TIME 7
PA.18	Multi-step speed 8	-100.0~100.0%	0.0%	<input type="radio"/>	MULTI-SPEED 8
PA.19	8 th Step running time	0.0~6553.5s(h)	0.0s	<input type="radio"/>	RUNNING TIME 8
PA.20	Multi-step speed 9	-100.0~100.0%	0.0%	<input type="radio"/>	MULTI-SPEED 9
PA.21	9 th Step running time	0.0~6553.5s(h)	0.0s	<input type="radio"/>	RUNNING TIME 9
PA.22	Multi-step speed 10	-100.0~100.0%	0.0%	<input type="radio"/>	MULTI-SPEED 10
PA.23	10 th Step running time	0.0~6553.5s(h)	0.0s	<input type="radio"/>	RUNNING TIME 10
PA.24	Multi-step speed 11	-100.0~100.0%	0.0%	<input type="radio"/>	MULTI-SPEED 11
PA.25	11 th Step running time	0.0~6553.5s(h)	0.0s	<input type="radio"/>	RUNNING TIME 11
PA.26	Multi-step speed 12	-100.0~100.0%	0.0%	<input type="radio"/>	MULTI-SPEED 12
PA.27	12 th Step running time	0.0~6553.5s(h)	0.0s	<input type="radio"/>	RUNNING TIME 12
PA.28	Multi-step speed 13	-100.0~100.0%	0.0%	<input type="radio"/>	MULTI-SPEED 13
PA.29	13 th Step running time	0.0~6553.5s(h)	0.0s	<input type="radio"/>	RUNNING TIME 13

Function Code	Name	Description	Factory Setting	Modify	LCD Display
PA.30	Multi-step speed 14	-100.0~100.0%	0.0%	<input type="radio"/>	MULTI-SPEED 14
PA.31	14 th Step running time	0.0~6553.5s(h)	0.0s	<input type="radio"/>	RUNNING TIME 14
PA.32	Multi-step speed 15	-100.0~100.0%	0.0%	<input type="radio"/>	MULTI-SPEED 15
PA.33	15 th Step running time	0.0~6553.5s(h)	0.0s	<input type="radio"/>	RUNNING TIME 15
PA.34	ACC/DEC time selection for step 0~7	0~65535	0	<input type="radio"/>	0~7 TIME SELECT
PA.35	ACC/DEC time selection for step 8~15	0~65535	0	<input type="radio"/>	8~15 TIME SELECT
PA.36	Time unit	0: Second 1: Hour	0	<input checked="" type="radio"/>	TIME UNIT
PB Group: Protection Function					
PB.00	Input phase-failure protection	0: Disabled 1: Enabled	1	<input type="radio"/>	IN PHASE FAIL
PB.01	Output phase-failure protection	0: Disabled 1: Enabled	1	<input type="radio"/>	OUT PHASE FAIL
PB.02	Motor overload protection	0: Disabled 1: Normal motor 2: Variable frequency motor	2	<input checked="" type="radio"/>	MOTOR OVERLOAD
PB.03	Motor overload protection current	20.0%~120.0%	100.0%	<input type="radio"/>	OVERLOAD CURR
PB.04	Overload pre-warning threshold	20.0%~150.0%	130.0%	<input type="radio"/>	OL WARN CURR

Function Code	Name	Description	Factory Setting	Modify	LCD Display
PB.05	Overload pre-warning selection	0: Always detect relative to motor rated current 1: Detect while constant speed relative to motor rated current 2: Always detect relative to inverter rated current 3: Detect while constant speed relative to inverter rated current	0	<input checked="" type="radio"/>	OL WARN SELECT
PB.06	Overload pre-warning delay time	0.0~30.0s	5.0s	<input type="radio"/>	OL WARN DELAY
Pb.07	Threshold of trip-free	230.0V~600.0V	450.0V	<input type="radio"/>	TRIPFREE POINT
PB.08	Decrease rate of trip-free	0.00Hz~P0.07	0.00Hz	<input type="radio"/>	TRIPFREE DECRATE
PB.09	Over-voltage stall protection	0: Disabled 1: Enabled	0	<input type="radio"/>	OVER VOLT STALL
PB.10	Over-voltage stall protection point	120~150%	125%	<input type="radio"/>	OV PROTECT POINT
PB.11	Over-current protection	0: Disabled 1: Enabled	1	<input type="radio"/>	OVER CURR
PB.12	Over-current stall threshold	100~200%	160%	<input type="radio"/>	OC THRESHOLD
PB.13	Frequency decrease rate	0.00~50.00Hz/s	1.00 Hz/s	<input type="radio"/>	FREQ DEC RATE
PC Group: Serial Communication					
PC.00	Local address	1~247 0: broadcast address	1	<input type="radio"/>	LOCAL ADDRESS

Function Code	Name	Description	Factory Setting	Modify	LCD Display
PC.01	Baud rate selection	0: 1200BPS 1: 2400BPS 2: 4800BPS 3: 9600BPS 4: 19200BPS 5: 38400BPS	4	<input type="radio"/>	BAUD RATE
PC.02	Data format	0: RTU, 1 start bit, 8 data bits, no parity check, 1 stop bit. 1: RTU, 1 start bit, 8 data bits, even parity check, 1 stop bit. 2: RTU, 1 start bit, 8 data bits, odd parity check, 1 stop bit. 3: RTU, 1 start bit, 8 data bits, no parity check, 2 stop bits. 4: RTU, 1 start bit, 8 data bits, even parity check, 2 stop bits. 5: RTU, 1 start bit, 8 data bits, odd parity check, 2 stop bits. 6: ASCII, 1 start bit, 7 data bits, no parity check, 1 stop bit. 7: ASCII, 1 start bit, 7 data bits, even parity check, 1 stop bit. 8: ASCII, 1 start bit, 7 data bits, odd parity check, 1 stop bit.	0	<input type="radio"/>	DATA FORMAT

Function Code	Name	Description	Factory Setting	Modify	LCD Display
		9: ASCII, 1 start bit, 7 data bits, no parity check, 2 stop bits. 10: ASCII, 1 start bit, 7 data bits, even parity check, 2 stop bits. 11: ASCII, 1 start bit, 7 data bits, odd parity check, 2 stop bits. 12: ASCII, 1 start bit, 8 data bits, no parity check, 1 stop bit. 13: ASCII, 1 start bit, 8 data bits, even parity check, 1 stop bit. 14: ASCII, 1 start bit, 8 data bits, odd parity check, 1 stop bit. 15: ASCII, 1 start bit, 8 data bits, no parity check, 2 stop bits. 16: ASCII, 1 start bit, 8 data bits, even parity check, 2 stop bits. 17: ASCII, 1 start bit, 8 data bits, odd parity check, 2 stop bits.			
PC.03	Communication delay time	0~20ms	0	<input type="radio"/>	COM DELAY TIME
PC.04	Communication timeout delay	0.0 (invalid) 0.1~100.0s	0.0s	<input type="radio"/>	COM TIMEOUT
PC.05	Response action	0: Enabled 1: Disabled	0	<input type="radio"/>	RESPONSE ACTION

Function Code	Name	Description	Factory Setting	Modify	LCD Display
PC.06	Communication fault action	0: Alarm and coast to stop 1: Not alarm and keep running 2: Not alarm and stop if command source is communication 3: Not alarm and stop in any command source	0~3	0	FAULT ACTION
PD Group: Supplementary Function					
PD.00	Upper frequency limit selection	0: Keypad 1: AI1 2: AI2 3: AI3 4: AI4 5: HDI 1 6: HDI 2 7: communication	0	○	UPPER FREQ LIMIT
PD.01	NO/NC input selection	0~0x3FF	0x000	◎	NO/NC SELECT
PE Group: Factory Setting					
PE.00	Factory Password	0~65535	*****	●	FACTORY PASSWORD